

SAE Cavity cartridges

TECHNICAL CATALOG



Additional information

This catalogue shows the product in the most standard configurations.
Please contact our Sales Dpt. for more detailed information or special requests.

WARNING!

All specifications of this catalogue refer to the standard product at this date.
Walvoil, oriented to a continuous improvement, reserves the right to discontinue, modify or revise the specifications, without notice.

WALVOIL IS NOT RESPONSIBLE FOR ANY DAMAGE CAUSED BY AN
INCORRECT USE OF THE PRODUCT.

13th edition May 2020

Pressure control valves

Pressure relief valves

Hydraulic diagram	Valve	Execution	Operation	Control type	Max. flow up to		Max. press. up to		Page	
					l/min	US gpm	bar	psi		
2 way										
	MC12A	poppet	direct	mechanic	100	26	350	5100	11	
	MC10M	poppet	direct	mechanic	70	18.5	350	5100	13	
	MC..R	poppet	direct	mechanic	50	13.2	350	5100	15	
	MC08Y	poppet	direct	solenoid proportional	1	0.3	350	5100	17	
	MC10T	poppet	direct	solenoid proportional	3	0.8	350	5100	19	
	MC10T HF type									
	MC10X	poppet	direct	solenoid proportional	3.5	0.9	350	5100	23	
	MC10X HF type									
	MD..M	poppet	direct	mechanic	100	26.4	350	5100	27	
	MG..A	poppet	direct	mechanic	100	26.4	350	5100	33	
	MP..A	spool	pilot	mechanic	100	26.4	350	5100	35	
	MP16M	spool	pilot	mechanic	400	105.67	350	5100	39	
	MP..T	spool	pilot	solenoid proportional	120	31.7	350	5100	41	
	MP..X	spool	pilot	solenoid proportional	120	31.7	350	5100	45	
	MP16Y	spool	pilot	solenoid proportional	150	40	350	5100	49	

Pressure control valves

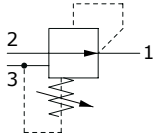
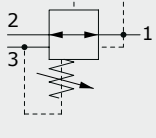
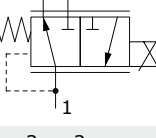
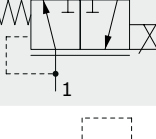
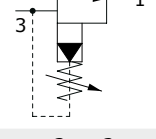
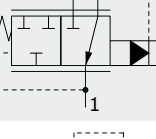
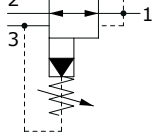
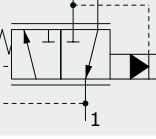
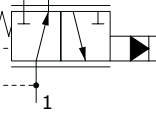
Pressure reducing valves									
Hydraulic diagram	Valve	Execution	Operation	Control type	Max. flow up to		Max. press. up to		Page
					l/min	US gpm	bar	psi	
3 way									
	RB..A	spool	direct	mechanic	30	7.9	line 1 = 150 line 2 = 350	line 1 = 2200 line 2 = 5100	51
	RD..A	spool	direct	mechanic	30	7.9	line 1 = 150 line 2 = 350	line 1 = 2200 line 2 = 5100	53
	RD08W	spool	direct	solenoid proportional	4	1.05	350	5100	55
	RD08S RD08T	spool	direct	solenoid proportional	12	3.17	210	3050	57
	RM..A	spool	pilot	mechanic	150	40	line 1 = 350 line 2 = 350	line 1 = 5100 line 2 = 5100	61
	RM..W	spool	pilot	solenoid proportional	150	40	350	5100	65
	RP..A	spool	pilot	mechanic	150	40	line 1 = 210 line 2 = 350	line 1 = 3050 line 2 = 5100	69
	RP..W	spool	pilot	solenoid proportional	150	40	350	5100	73
	RP08X	spool	pilot	solenoid proportional	15	4	350	5100	77

Sequence valve

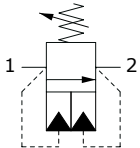
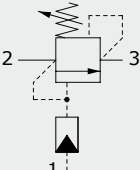
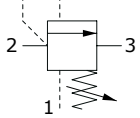
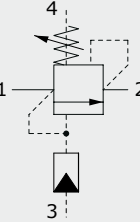
Sequence valves									
Hydraulic diagram	Valve	Execution	Operation	Control type	Max. flow up to		Max. press. up to		Page
					l/min	US gpm	bar	psi	
2 way									
	SW..A	spool	pilot	mechanic	180	48	350	5100	79
3 way									
	SE..A	spool	direct	mechanic	20	5.3	210	3050	81
	SP10A	spool	pilot	mechanic	50	13	350	5100	83
4 way									
	SG12A	poppet	direct	mechanic	50	13	300	4350	85

Motion control valves

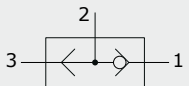
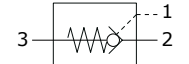
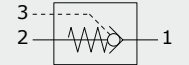
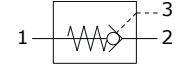
Check valves and shuttle valves									
Hydraulic diagram	Valve	Execution	Operation	Control type	Max. flow up to		Max. press. up to		Page
					l/min	US gpm	bar	psi	
2 way									
	UC..A	poppet	direct	mechanic	100	26	350	5100	87
3 way									
	UT..A	ball	/	mechanic	20	5.3	350	5100	89
	BC..A	poppet	direct	mechanic	100	26	350	5100	91
	BC..B	poppet	direct	mechanic	100	26	350	5100	91
	BC..C	poppet	direct	mechanic	60	16	350	5100	91

Motion control valves

Counterbalance valves									
Hydraulic diagram	Valve	Execution	Operation	Control type	Max. flow up to		Max. press. up to		Page
					l/min	US gpm	bar	psi	
3 way									
	CA..A	poppet	/	mechanic	90	23.8	350	5100	95
	CC..A	poppet	/	mechanic	150	40	350	5100	99

Flow control valves

Flow restrictor									
Hydraulic diagram	Valve	Execution	Operation	Control type	Max. flow up to		Max. press. up to		Page
					l/min	US gpm	bar	psi	
2 way									
	NB..A	poppet	/	mechanic	100	26	350	5100	103
	NU..A	poppet	/	mechanic	100	26	350	5100	105
	NT..A	poppet	/	mechanic	100	26	350	5100	107
	EE..X	spool	direct	solenoid proportional	60	16	315	4600	109
	EC..T	poppet	pilot	solenoid proportional	97	25.6	350	5100	113

Flow control valves

Flow control pressure compensated valves

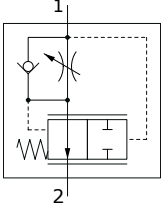
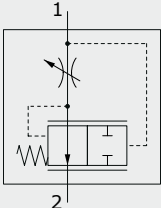
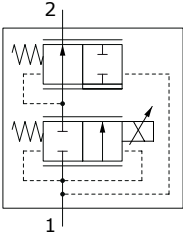
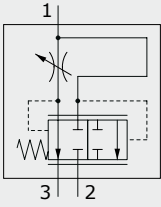
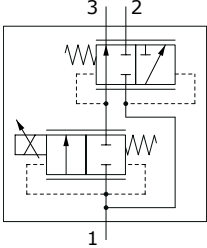
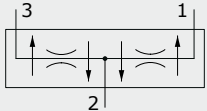
Hydraulic diagram	Valve	Execution	Operation	Control type	Max. flow up to		Max. press. up to		Page	
					l/min	US gpm	bar	psi		
2 way										
	PW..A	spool	direct	mechanic	90	24	315	4600	117	
	PU..A	spool	direct	mechanic	90	24	315	4600	121	
	PU..X	spool	direct	solenoid proportional	90	24	315	4600	125	
3 way										
	PP..A	spool	direct	mechanic	90	24	350	5100	129	
	PP..X	spool	direct	solenoid proportional	90	24	350	5100	133	
	PD	spool	direct	mechanic	150	40	210	3045	137	

Logic valves

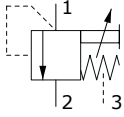
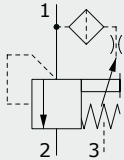
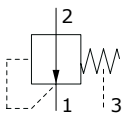
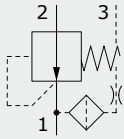
Logic valves									
Hydraulic diagram	Valve	Execution	Operation	Control type	Max. flow up to		Max. press. up to		Page
					l/min	US gpm	bar	psi	
	LA..QA	spool	pilot to close	/	190	50.2	350	5100	139
	LB..QA	spool	venting to open	/	190	50.2	350	5100	141
	LC..QA	spool	venting to close	/	150	39.6	350	5100	143
	LD..QA	spool	pilot to open	/	150	39.6	350	5100	145

Directional control valves

Solenoid directional valves										
Hydraulic diagram	Valve	Execution	Operation	Control type	Max. flow up to		Max. press. up to		Page	
					l/min	US gpm	bar	psi		
2 way / 2 positions										
	EA08⁽¹⁾	poppet	direct	solenoid	1	0.6	350	5100	147	
	EE..A⁽¹⁾	spool	direct	solenoid	40	10.5	210	3050	149	
	EC..M⁽¹⁾	poppet	pilot	solenoid	150	40	380	5500	153	
	EF..M⁽¹⁾	poppet	pilot	solenoid	150	40	380	5500	157	
	EH..M⁽¹⁾	poppet	pilot	solenoid	150	40	380	5500	161	
	EW...	poppet	direct	solenoid	50	13.2	210	3050	165	
	EW..M	poppet	direct	solenoid	40	10.5	350	5100	169	
3 way / 2 positions										
	EJ08F	spool	direct	solenoid	12	3.2	50	725	173	
	EJ8CA	spool	direct	solenoid	10	2.6	70	18.5	175	
	EJ08G	spool	direct	solenoid	3	0.8	350	5100	177	
	EJ..M⁽²⁾	spool	direct	solenoid	40	10.5	250	3600	179	
	EJ12A⁽²⁾	spool	direct	solenoid	40	10.5	210	3050	185	
	EL...	poppet	direct	solenoid	20	5.3	210	3050	189	
	EL08B	poppet	direct	solenoid	10	2.6	250	3600	191	
4 way / 2 positions										
	ER..M⁽²⁾	spool	direct	solenoid	60	15.8	250	3600	193	
4 way / 3 positions										
	ET..M⁽²⁾	spool	direct	solenoid	40	10.5	210	3050	199	
	ET12A⁽²⁾	spool	direct	solenoid	40	10.5	210	3050	203	

Note (1) the circuit shown are in normally open configuration; normally closed configuration is also available, see valves pages.

Note (2) the circuit shown are one type of available spools; for several types of spools see valves pages.

Accessori

Coils and connectors

- Types and ordering codespage 206
- Dimensional data and featurespage 207

Adjustments

- Types and dimensionspage 212

Emergency

- Types and dimensionspage 213

Valve bodies

- 2 way bodiespage 215
- 3 way bodiespage 217
- 4 way bodiespage 219
- How to order valves with bodypage 221

Cavity tools and tap

- 2 way SAE cavitypage 222
- 3 way SAE cavitypage 223
- 4 way SAE cavitypage 224



MC12A type pressure relief valves - 2 way

- Direct acting
- Poppet type
- From SAE12 cavities

Technical specifications and diagrams are measured with mineral oil of 46 cSt viscosity at 40°C (104°F) temperature.

MC12A	
Nominal flow	100 l/min (26.4 US gpm)
Max. pressure	350 bar (5100 psi)
Oil leakage	-
Fluid	mineral based oil
Viscosity	10-200 cSt
Max level of contamination	20/18/14 ISO4406
Fluid temperature	with NBR seals from -20°C (-4°F) to 80°C (176°F) with FPM seals from -20°C (-4°F) to 100°C (212°F)
Environmental temp. for working conditions	from -20°C (-4°F) to 50°C (122°F)
Cavity	SAE 12/2
Weight	0.86 kg (1.89 lb)

NOTE - For different conditions, please contact Walvoil Sales Dpt.

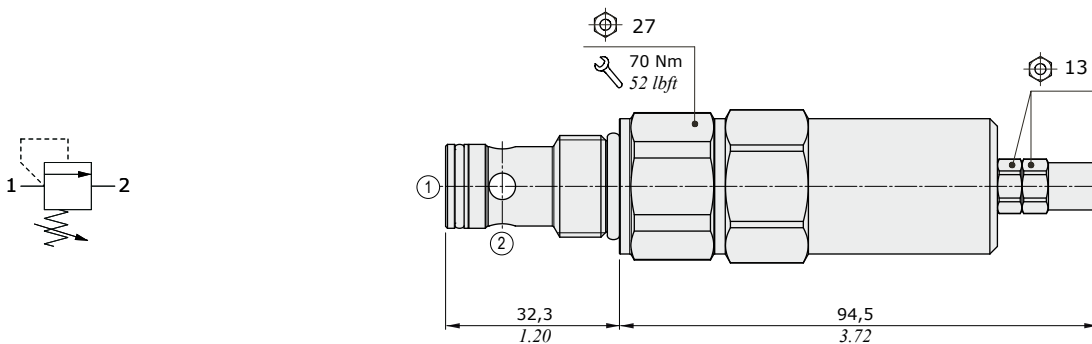

For dimensions with different type of adjustment see page 212

Ordering codes and description composition

MC12A/0S2B

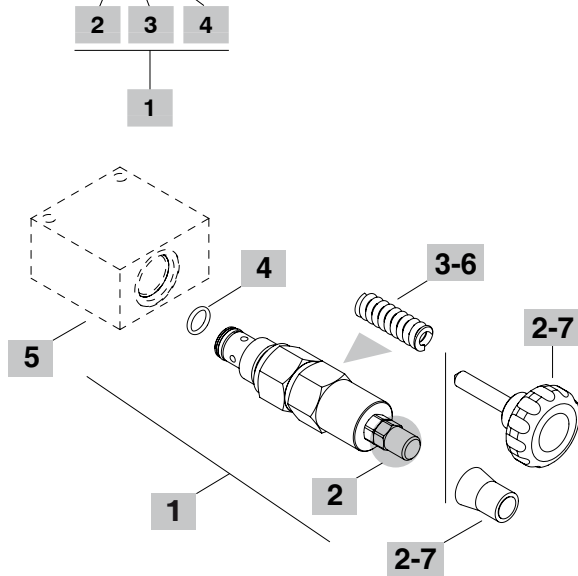

2 Adjustments

TYPE	DESCRIPTION
S	With screw
V	With handwheel (part code: see point 7)
X	Valve set with antitampering cap (part code: see point 7)

3 Pressure range

Standard setting is referred to 5 l/min (1.32 US gpm) flow

TYPE	DESCRIPTION
1	Range 20÷100 bar (290÷1450 psi); Std. setting 50 bar (725 psi), pressure increase by steps of 5,7 bar (83 psi) per screw turn
2	Range 50÷200 bar (725÷2900 psi); Std. setting 150 bar (2175 psi), pressure increase by steps of 26,5 bar (348 psi) per screw turn
3	Range 150÷350 bar (725÷1450 psi); Std. setting 250 bar (3600 psi), pressure increase by steps of 35 bar (508 psi) per screw turn

4 Seals

TYPE	DESCRIPTION
B	NBR (Buna) o-ring seals, std configuration
V	FPM (Viton) o-ring seals, contact Sales Dept.

5 Valve body

TYPE	CODE	DESCRIPTION
SAE 12/2-SAE10	3CC1220L11	Aluminium body for cavity 12 valve, SAE10 std thread

Note: aluminium body can stand up to 210 bar (3050 psi)
For steel bodies or different threading see from page 215

6 Springs

TYPE	CODE	DESCRIPTION
1	3ML1166804	Pressure range 1 - green band
2	3ML1146800	Pressure range 2 - blue band
3	3ML1166805	Pressure range 3 - red band

7 Accessories

TYPE	CODE	DESCRIPTION
-	4VL2407100	Handwheel
-	4COP120420	Antitampering cap

1 Cartridges

TYPE	CODE	DESCRIPTION
SAE cavity 08/2		
MC08A/0S2B	0MC08002000	Cartridge
SAE cavity 10/2		
MC10A/0S2B	0MC10002000	Cartridge
SAE cavity 12/2		
MC12A/0S2B	0MC12002001	Cartridge

Rating diagrams

MC12A pressure vs. flow
Std. setting at 5 l/min (1.32 US gpm)

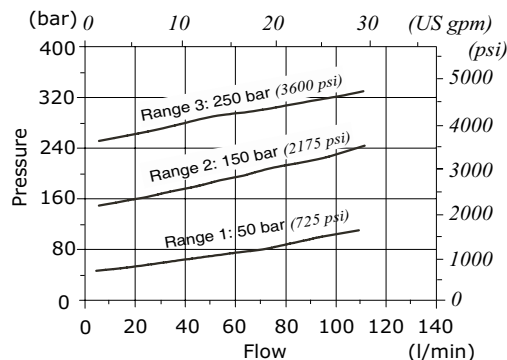



MC10M type pressure relief valve - 2 way

- Direct acting
- Poppet type

Technical specifications and diagrams are measured with mineral oil of 46 cSt viscosity at 40°C (104°F) temperature.

MC10M		
Nominal flow		70 l/min (18.5 US gpm)
Max. pressure		260 bar (3770 psi)
Oil leakage	80% of max. pressure setting	4 cm ³ /min (0.24 in ³ /min)
Fluid		mineral based oil
Viscosity		10-200 cSt
Max level of contamination		20/18/14 ISO4406
Fluid temperature	with NBR seals with FPM seals	from -20°C (-4°F) to 80°C (176°F) from -20°C (-4°F) to 100°C (212°F)
Environmental temp. for working conditions		from -20°C (-4°F) to 50°C (122°F)
Cavity		SAE 10/2 A
Weight		0.18 kg (0.396 lb)

NOTE - For different conditions, please contact Walvoil Sales Dpt.

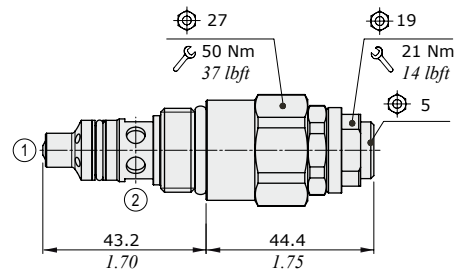
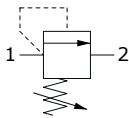

Ordering codes and description composition

MC10M/OY1B

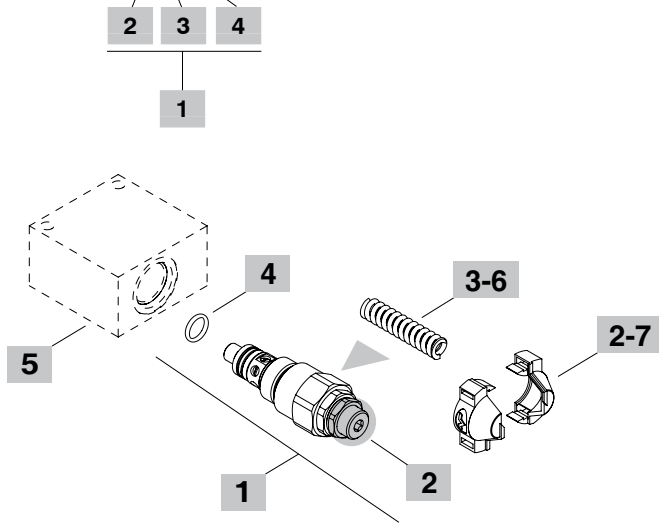

3 Pressure range

Standard setting is referred to 5 l/min (1.32 US gpm) flow

TYPE	DESCRIPTION
1	Pressure range 10÷60 bar (145÷870 psi); Std. setting 50 bar (725 psi)
2	Pressure range 40÷110 bar (580÷1595 psi); Std. setting 80 bar (1160 psi)
3	Pressure range 110÷220 bar (1595÷3190 psi); Std. setting 175 bar (2540 psi)
4	Pressure range 200÷260 bar (2900÷3770 psi); Std. setting 220 bar (3190 psi)

4 Seals

TYPE	DESCRIPTION
B	NBR (Buna) o-ring seals, std configuration
V	FPM (Viton) o-ring seals, contact Sales Dept.

5 Valve body

TYPE	CODE	DESCRIPTION
SAE 10/2-SAE8	3CC1020K11	Aluminium body for cavity 10 valve, SAE8 std thread

Note: aluminium body can stand up to 210 bar (3050 psi)
For steel bodies or different threading see from page 215

1 Cartridges

TYPE	CODE	DESCRIPTION
MC10M/OY1B	OMC10002026	Pressure range 1
MC10M/OY2B	OMC10002027	Pressure range 2
MC10M/OY3B	OMC10002028	Pressure range 3
MC10M/OY4B	OMC10002029	Pressure range 4

2 Adjustments

TYPE	DESCRIPTION
Y	With screw
X	Valve set with antitampering cap (part code: see point 7)

6 Springs

TYPE	CODE	DESCRIPTION
1	3ML1114500	Pressure range 1 - no band
2	3ML1114502	Pressure range 2 - blue band
3	3ML1114501	Pressure range 3 - red band
4	3ML1114503	Pressure range 4 - green band

7 Accessories

TYPE	CODE	DESCRIPTION
-	4COP126301	Antitampering cap (x2)

Rating diagrams

MC10M pressure vs. flow
Std. setting at 5 l/min (1.32 US gpm)

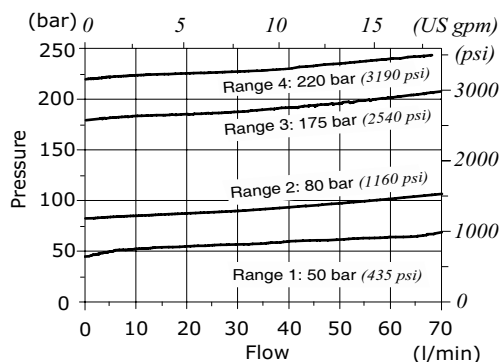



MC..R type pressure relief valves - 2 way

- Direct acting
- Poppet type
- From SAE08 to SAE10 cavities

Technical specifications and diagrams are measured with mineral oil of 46 cSt viscosity at 40°C (104°F) temperature.

	MC08R	MC09R	MC10R
Nominal flow	25 l/min (6.6 US gpm)	35 l/min (9.2 US gpm)	50 l/min (13.2 US gpm)
Max. pressure		350 bar (5100 psi)	
Oil leakage	80% of max. pressure setting	2 cm ³ /min (0.122 in ³ /min)	
Fluid		mineral based oil	
Viscosity		10-200 cSt	
Max level of contamination		20/18/14 ISO4406	
Fluid temperature	with NBR seals with FPM seals	from -20°C (-4°F) to 80°C (176°F) from -20°C (-4°F) to 100°C (212°F)	
Environmental temp. for working conditions		from -20°C (-4°F) to 50°C (122°F)	
Cavity	SAE 08/2 A	SAE 9/2 A	SAE 10/2 A
Weight	0.170 kg (0.37 lb)	0.230 kg (0.51 lb)	0.315 kg (0.69 lb)

NOTE - For different conditions, please contact Walvoil Sales Dpt.

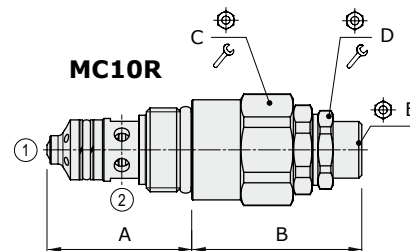
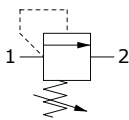

Valve type	A		B		C	D	E	C		D	
	mm	in	mm	in				Nm	lbft	Nm	lbft
MC08R	34	1.34	46.6	1.83	24	19	5	30	22	25	18
MC09R	33.8	1.33	46,6	1.83	24	19	5	42	31	25	18
MC10R	38.3	1.50	44.4	1.75	27	19	5	50	37	25	18

Ordering codes and description composition

MC08R/OY1B

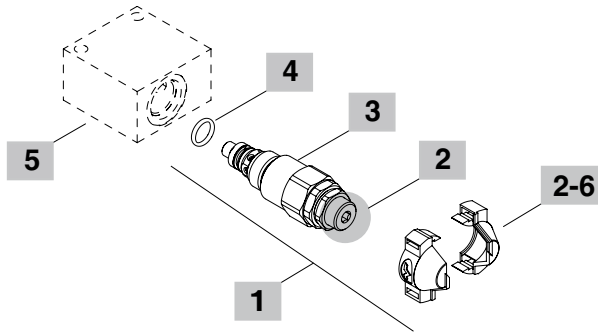
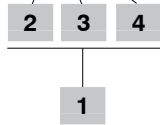

2 Adjustments

TYPE	DESCRIPTION
Y	With screw
X	Valve set with antitampering cap (part code: see point 6)

3 Pressure range

Standard setting is referred to 5 l/min (1.32 US gpm) flow

TYPE	DESCRIPTION
1	Pressure range 10÷120 bar (145÷1740 psi); Std. setting 80 bar (1160 psi)
2	Pressure range 40÷200 bar (580÷2900 psi); Std. setting 175 bar (2540 psi)
3	Pressure range 200÷350 bar (2900÷5100 psi); Std. setting 250 bar (3600 psi)

4 Seals

TYPE	DESCRIPTION
B	NBR (Buna) o-ring seals, std configuration
V	FPM (Viton) o-ring seals, contact Sales Dept.

5 Valve body

TYPE	CODE	DESCRIPTION
SAE 08/2-SAE8	3CC0820K11	Aluminium body for cavity 08 valve, SAE8 std thread
SAE 09/2-G 3/8	3CC0920C11	Aluminium body for cavity 09 valve, G 3/8 std thread
SAE 10/2-SAE8	3CC1020K11	Aluminium body for cavity 10 valve, SAE8 std thread

Note: aluminium body can stand up to 210 bar (3050 psi)
For steel bodies or different threading see from page 215

6 Accessories

TYPE	CODE	DESCRIPTION
-	4COP126301	Antitampering cap (X2)

1 Cartridges

TYPE	CODE	DESCRIPTION
SAE cavity 08/2 A		
MC08R/OY1B	OMC08002050	Pressure range 1
MC08R/OY2B	OMC08002051	Pressure range 2
MC08R/OY3B	OMC08002052	Pressure range 3
SAE cavity 09/2 A		
MC09R/OY1B	OMC09002000	Pressure range 1
MC09R/OY2B	OMC09002001	Pressure range 2
MC09R/OY3B	OMC09002002	Pressure range 3
SAE cavity 10/2 A		
MC10R/OY1B	OMC10002023	Pressure range 1
MC10R/OY2B	OMC10002024	Pressure range 2
MC10R/OY3B	OMC10002025	Pressure range 3

Rating diagrams

MC08R pressure vs. flow

Std. setting at 5 l/min (1.32 US gpm)

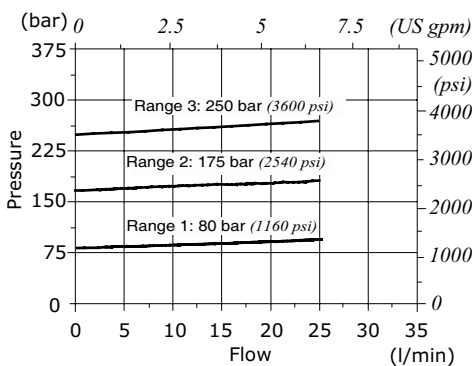

MC09R pressure vs. flow

Std. setting at 5 l/min (1.32 US gpm)

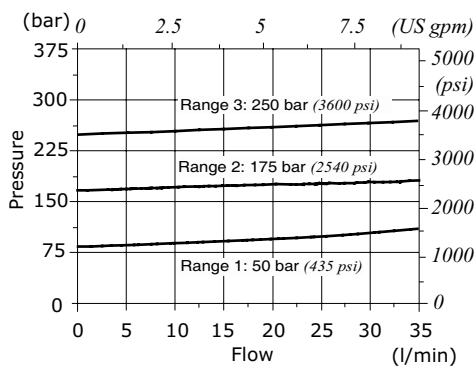

MC10R pressure vs. flow

Std. setting at 5 l/min (1.32 US gpm)

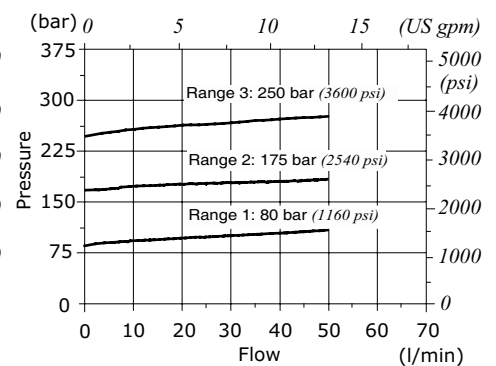



MC08Y type pressure relief valve - 2 way

- Solenoid proportional type, direct acting
- Increasing pressure with increasing current (NO)
- Poppet type

Technical specifications and diagrams are measured with mineral oil of 46 cSt viscosity at 40°C (104°F) temperature.

MC08Y		
Nominal flow		0.5 l/min (0.15 US gpm)
Max. flow		1 l/min (0.3 US gpm)
Max. pressure		350 bar (5100 psi)
Oil leakage	80% of max. pressure setting	2 cm ³ /min (0.122 in ³ /min)
Fluid		mineral based oil
Viscosity		10-200 cSt
Max level of contamination		18/16/13 ISO4406
Fluid temperature	with NBR seals with FPM seals	from -20°C (-4°F) to 80°C (176°F) from -20°C (-4°F) to 100°C (212°F)
Environmental temp. for working conditions		from -40°C (-40°F) to 100°C (212°F)
Cavity		SAE 08/2
Coil type*		MP35
Nominal voltages		12 VDC - 24V DC
Power rating		11.2 W (12 VDC) - 11.4 W (24 VDC)
Max control current		12 V -> 1.1 A - 24 V -> 0.68 A
Dither frequency		150 Hz
Hysteresis		≤5%
Weight		0.55 kg (1.212 lb)

NOTE - For different conditions, please contact Walvoil Sales Dpt. - For coils further features see from page 206.

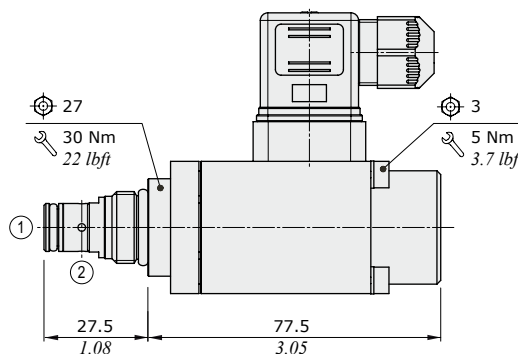
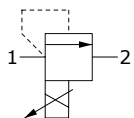

Ordering codes and description composition

MC08Y/021B

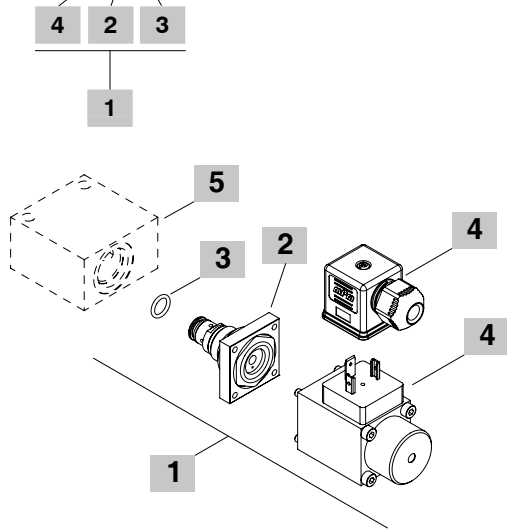

1 Cartridges

TYPE	CODE	DESCRIPTION
MC08Y/021B	0MC08002013	Pressure range 1 , 12VDC
MC08Y/022B	0MC08002010	Pressure range 2 , 12VDC
MC08Y/023B	0MC08002011	Pressure range 3 , 12VDC
MC08Y/024B	0MC08002022	Pressure range 4 , 12VDC

2 Pressure range

TYPE	DESCRIPTION
1	Pressure range 10÷100 bar (145÷1450 psi)
2	Pressure range 50÷200 bar (725÷2900 psi)
3	Pressure range 80÷350 bar (1160÷5100 psi)
4	Pressure range 5÷40 bar (72.5÷580 psi)

3 Seals

TYPE	DESCRIPTION
B	NBR (Buna) o-ring seals, std configuration
V	FPM (Viton) o-ring seals, contact Sales Dept.

4 Coils and connectors

TYPE	CODE	DESCRIPTION
2) MP35 12VDC	5SL4000120	12VDC-ISO4400 coil
ISO4400	4CN1009995	Connector
4) MP35 24VDC	4SL4000240	24VDC-ISO4400 coil
ISO4400	4CN1009995	Connector

For complete coils and connectors list see from page 206

5 Valve body

TYPE	CODE	DESCRIPTION
SAE 08/2-SAE6	3CC0820J11	Aluminium body for cavity 08 valve, SAE6 std thread

Note: aluminium body can stand up to 210 bar (3050 psi)

For steel bodies or different threading see from page 215

Rating diagrams

Pressure setting vs. % max. control current
at 0.5 l/min (0.13 US gpm)

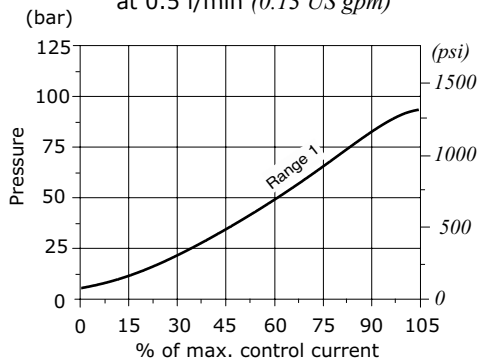

Pressure setting vs. % max. control current
at 0.5 l/min (0.13 US gpm)

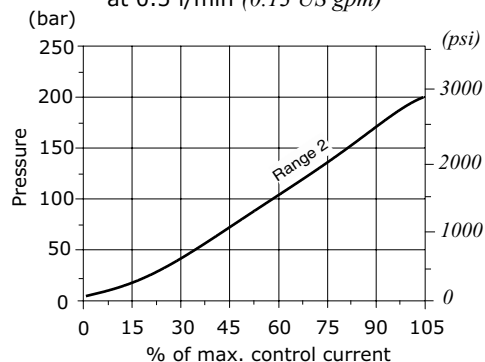

Pressure setting vs. % max. control current
at 0.5 l/min (0.13 US gpm)

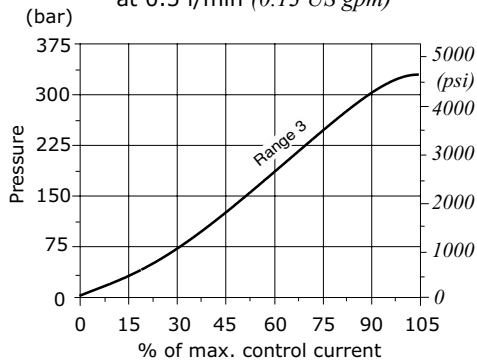

Pressure setting vs. % max. control current
at 0.5 l/min (0.13 US gpm)

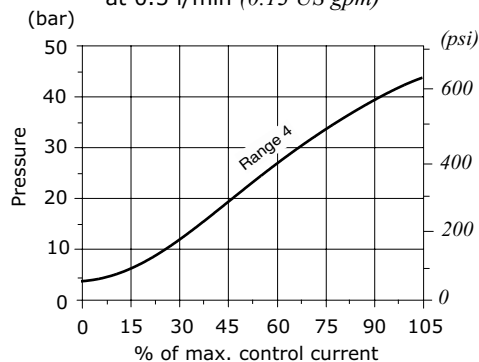



MC10T - MC10T-HF type pressure relief valve - 2 way

- Solenoid proportional type, direct acting
- Decreasing pressure with increasing current (NC)
- Poppet type

Technical specifications and diagrams are measured with mineral oil of 46 cSt viscosity at 40°C (104°F) temperature.

		MC10T	MC10T-HF
Max. flow		3 l/min (0.79 US gpm)	10 l/min (2.64 US gpm)
Max. pressure		350 bar (5100 psi)	250 bar (3600 psi)
Oil leakage	80% of max. pressure setting	0.25 cm ³ /min (0.015 in ³ /min)	0.50 cm ³ /min (0.030 in ³ /min)
Fluid		mineral based oil	
Viscosity		10-200 cSt	
Max level of contamination		18/16/13 ISO4406	
Fluid temperature	with NBR seals with FPM seals	from -20°C (-4°F) to 80°C (176°F) from -20°C (-4°F) to 100°C (212°F)	
Environmental temp. for working conditions		from -40°C (-40°F) to 100°C (212°F)	
Cavity		SAE 10/2	
Coil type*		BH or BQP19	BQP19
Nominal voltages		12 VDC - 24VDC	
Power rating		20.4 W (BH) - 15 W (BQP19)	15 W
Max control current		1 2V -> 1.70 A - 24 V -> 0.85 A (BH) 12 V-> 1.25 A - 24 V -> 0.63 A (BQP19)	12 V -> 1.25 A - 24 V -> 0.63 A
Dither frequency		150 Hz	
Hysteresis		<5%	
Weight		0.54 kg (1.19 lb)	0.87 kg (1.91 lb)

NOTE - For different conditions, please contact Walvoil Sales Dpt. - For coils further features see from page 206.

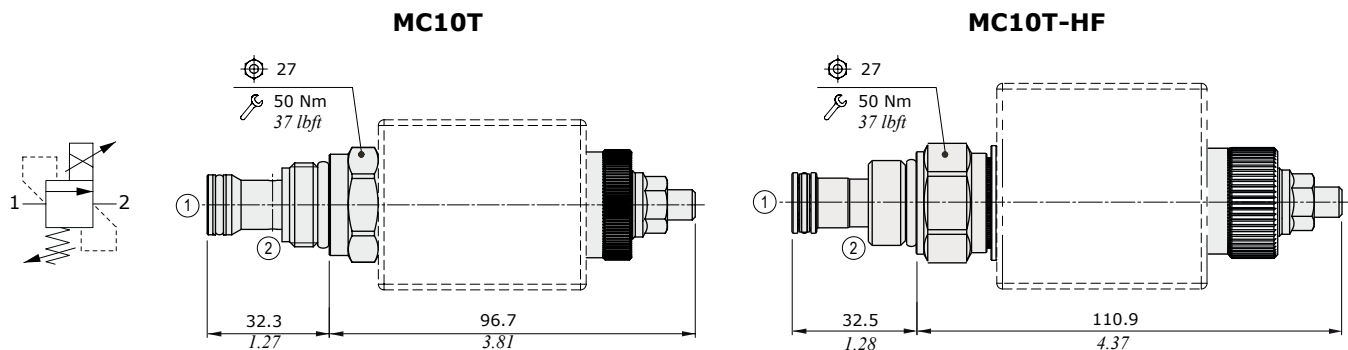

Ordering codes and description composition

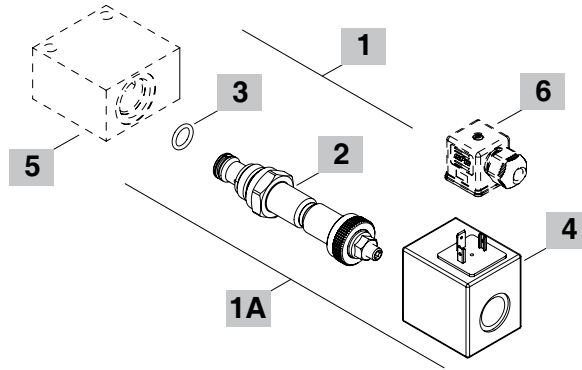
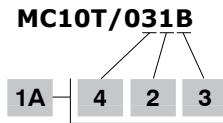
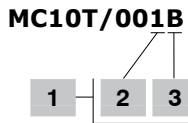

1 Cartridges

TYPE	CODE	DESCRIPTION
MC10T/001B	OMC10002047	Pressure range 1
MC10T/002B	OMC10002048	Pressure range 2
MC10T/003B	OMC10002049	Pressure range 3
MC10T-HF/003B	OMC10002068	Pressure range 3

1A Complete cartridges with coil

TYPE	CODE	DESCRIPTION
MC10T/031B	OMC10002019	Pressure range 1 , 12VDC
MC10T/032B	OMC10002020	Pressure range 2 , 12VDC
MC10T/033B	OMC10002021	Pressure range 3 , 12VDC

2 Pressure range

TYPE	DESCRIPTION
MC10T	
1	Pressure range 15÷130 bar (217÷1885 psi)
2	Pressure range 15÷170 bar (217÷2465 psi)
3	Pressure range 15÷210 bar (217÷3045 psi)
MC10T-HF	
3	Pressure range 20÷225 bar (290÷3260 psi)

Note: for further pressure range contact Sales Dept.

3 Seals

TYPE	DESCRIPTION
B	NBR (Buna) o-ring seals, std configuration
V	FPM (Viton) o-ring seals, contact Sales Dept.

4 Coils

TYPE	CODE	DESCRIPTION
2) BH 12VDC	4SLD001200	12VDC-ISO4400 coil
3) BQP19 12VDC	4SL5000126	12VDC-ISO4400 coil
4) BH 24VDC	4SLD002400	24VDC-ISO4400 coil
5) BQP19 24VDC	4SL5000245	24VDC-ISO4400 coil

Note: for HF version use only BQP19 coil
For complete coils list see from page 206

5 Valve body

TYPE	CODE	DESCRIPTION
SAE 10/2-SAE8	3CC1020K11	Aluminium body for cavity 10 valve, SAE8 std thread

Note: aluminium body can stand up to 210 bar (3050 psi)
For steel bodies or different threading see from page 215

6 Connector

TYPE	CODE	DESCRIPTION
ISO4400	4CN1009995	Connector

For complete connectors list see from page 206

Rating diagrams

MC10T pressure setting vs. % max. control current
at 1 l/min (0.26 US gpm)

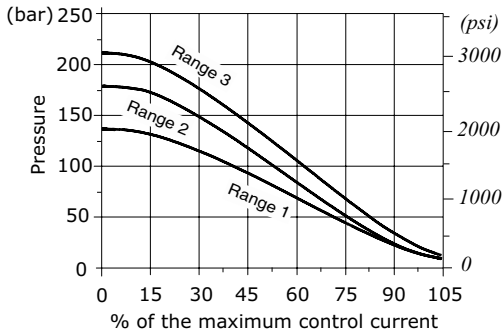

MC10T-HF pressure setting vs. % max. control current
at 2 l/min (0.53 US gpm)

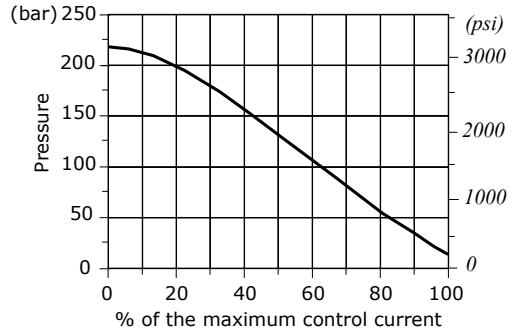

MC10T pressure vs. flow 1->2
for % of control current - Pressure range 1 -

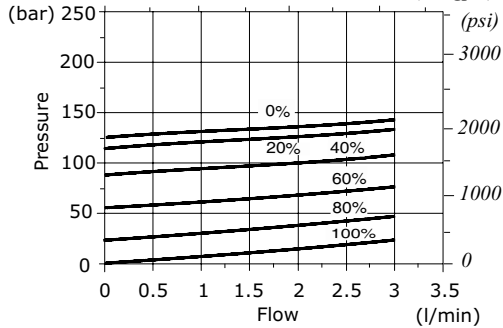

MC10T-HF pressure vs. flow 1->2
for % of control current

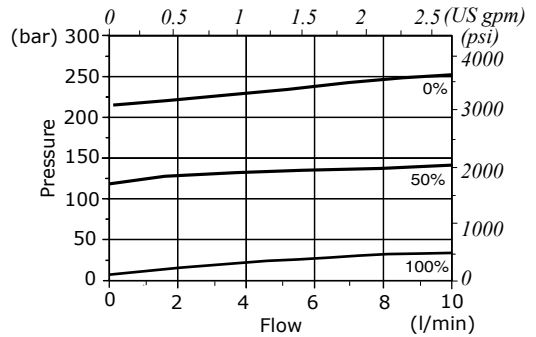

MC10T pressure vs. flow 1->2
for % of control current - Pressure range 2 -

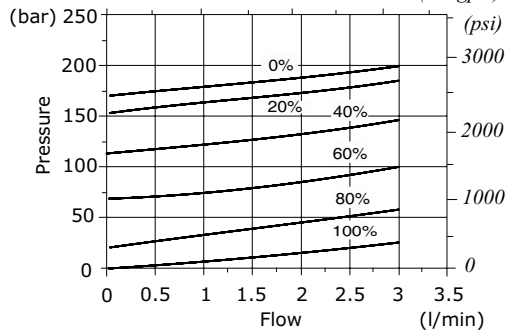

MC10T pressure vs. flow 1->2
for % of control current - Pressure range 3 -

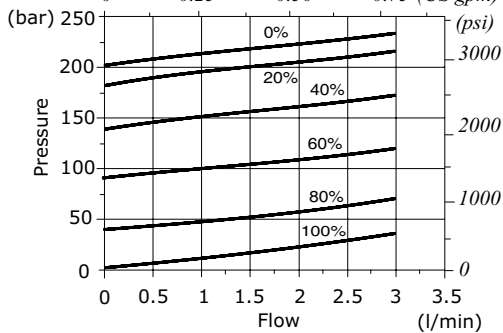





MC10X - MC10X-HF type pressure relief valve - 2 way

- Solenoid proportional type, direct acting
- Poppet type

Technical specifications and diagrams are measured with mineral oil of 46 cSt viscosity at 40°C (104°F) temperature.

	MC10X	MC10X-HF
Max. flow	3 l/min (0.79 US gpm)	10 l/min (2.64 US gpm)
Max. pressure	350 bar (5100 psi)	250 bar (3600 psi)
Oil leakage	80% of max. pressure setting	
	0.25 cm ³ /min (0.015 in ³ /min)	0.5 cm ³ /min (0.030 in ³ /min)
Fluid	mineral based oil	
Viscosity	10-200 cSt	
Max level of contamination	18/16/13 ISO4406	
Fluid temperature	with NBR seals with FPM seals	from -20°C (-4°F) to 80°C (176°F) from -20°C (-4°F) to 100°C (212°F)
Environmental temp. for working conditions	from -40°C (-40°F) to 100°C (212°F)	
Cavity	SAE 10/2	
Coil type*	BH or BQP19	BQP19
Nominal voltages	12 VDC - 24 VDC	
Power rating	20.4 W (BH) - 15 W (BQP19)	15 W
Max. control current	12 V -> 1.70 A - 24 V -> 0.85 A (BH) 12 V -> 1.25 A - 24 V -> 0.63 A (BQP19)	12 V -> 1.25 A - 24 V -> 0.63 A
Dither frequency	150 Hz	
Hysteresis	<5%	
Weight	0.760 kg (1.67 lb)	0.863 kg (1.90 lb)

NOTE - For different conditions, please contact Walvoil Sales Dpt. - For coils further features see from page 206.

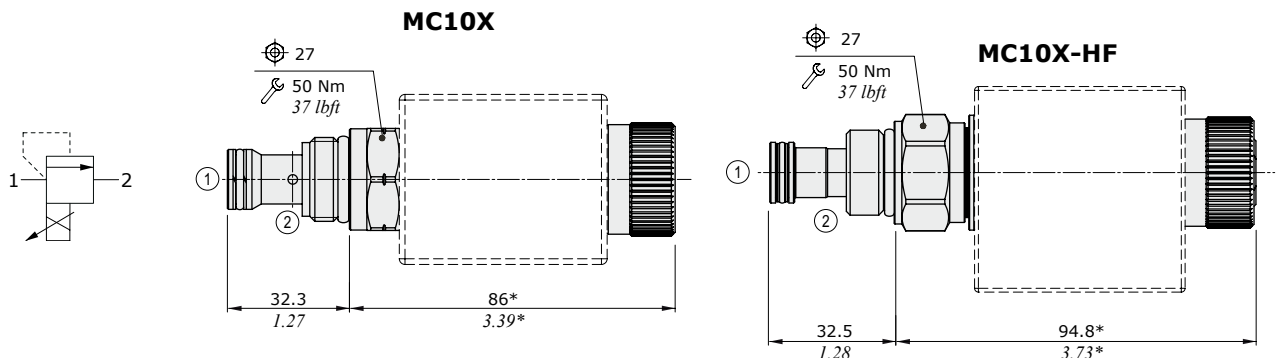

NOTE (*): dimension (*) : dimension for configuration without override, for dimensions with different type of emergency see page 213.

Ordering codes and description composition

MC10X/001B

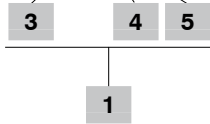

MC10X/031B

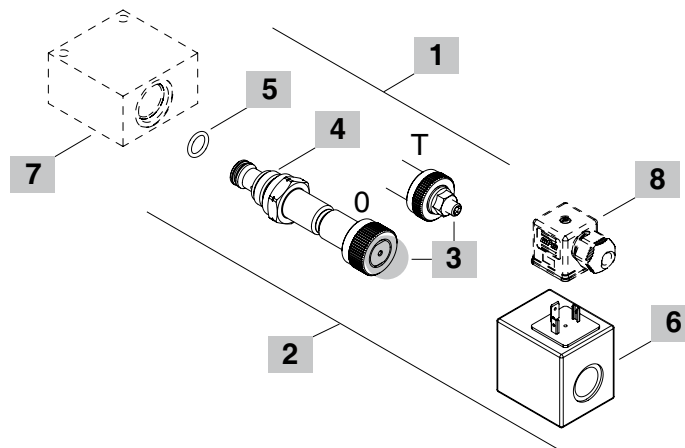
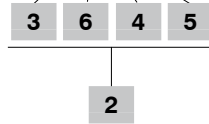

1 Cartridges

TYPE	CODE	DESCRIPTION
MC10X/001B	0MC10002050	Pressure range 1
MC10X/002B	0MC10002051	Pressure range 2
MC10X/003B	0MC10002052	Pressure range 3
MC10X-HF/003B	0MC10002064	Pressure range 3
MC10X-HF/T03B	0MC10002063	Pressure range 3

2 Complete cartridges with coil

TYPE	CODE	DESCRIPTION
<i>Note: not for MC10X-HF</i>		
MC10X/031B	0MC10002039	Pressure range 1 , 12VDC
MC10X/032B	0MC10002040	Pressure range 2 , 12VDC
MC10X/033B	0MC10002041	Pressure range 3 , 12VDC

3 Emergency

TYPE	DESCRIPTION
0	Without override
T	With screw

4 Pressure range

TYPE	DESCRIPTION
MC10X	
1	Pressure range 7÷120 bar (102÷1740 psi)
2	Pressure range 7÷170 bar (102÷2450 psi)
3	Pressure range 7÷210 bar (102÷3050 psi)

MC10X-HF

3	Pressure range 3÷230 bar (43÷3330 psi)
----------	--

Note: for further pressure range contact Sales Dept.

5 Seals

TYPE	DESCRIPTION
B	NBR (Buna) o-ring seals, std configuration
V	FPM (Viton) o-ring seals, contact Sales Dept.

6 Coil

TYPE	CODE	DESCRIPTION
2) BH 12VDC	4SLD001200	12VDC-ISO4400 coil
3) BQP19 12VDC	4SL5000126	12VDC-ISO4400 coil
4) BH 24VDC	4SLD002400	24VDC-ISO4400 coil
5) BQP19 24VDC	4SL5000245	24VDC-ISO4400 coil

Note: for HF version use only BQP19 coil
For complete coils list see from page 206

7 Valve body

TYPE	CODE	DESCRIPTION
SAE 10/2-SAE8	3CC1020K11	Aluminium body for cavity 10 valve, SAE8 std thread

Note: aluminium body can stand up to 210 bar (3050 psi)
For steel bodies or different threading see from page 215

8 Connector

TYPE	CODE	DESCRIPTION
ISO4400	4CN1009995	Connector

For complete connectors list see from page 206

Rating diagrams

MC10X pressure setting vs. % max. control current
at 1 l/min (0.26 US gpm)

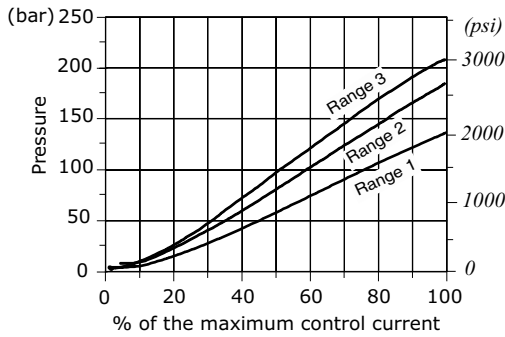

MC10X-HF pressure setting vs. % max. control current
at 2 l/min (0.53 US gpm)

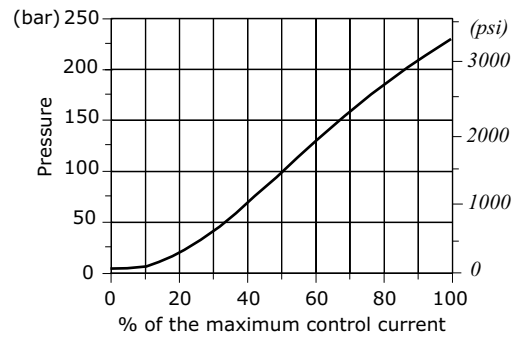

MC10X pressure vs. flow 1->2
for % of control current - Pressure range 1 -

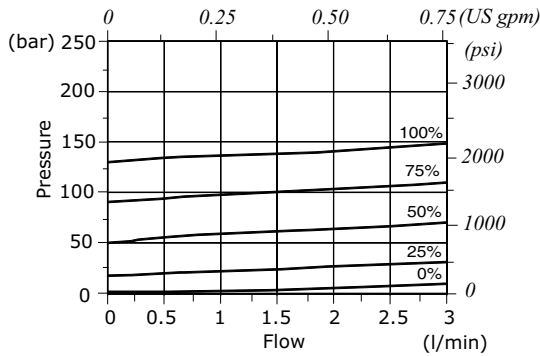

MC10X-HF pressure vs. flow 1->2
for % of control current

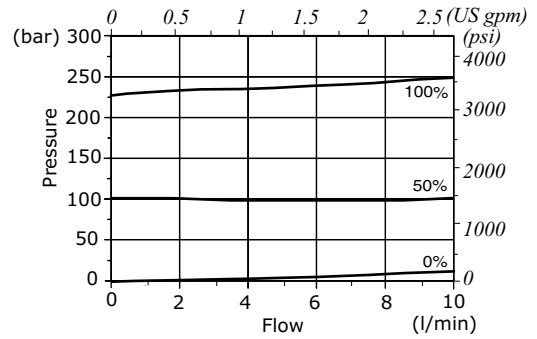

MC10X pressure vs. flow 1->2
for % of control current - Pressure range 2 -

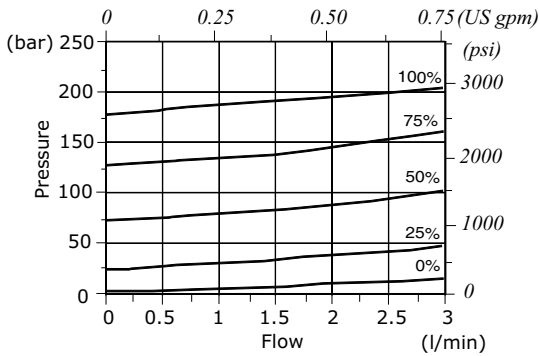

MC10X pressure vs. flow 1->2
for % of control current - Pressure range 3 -

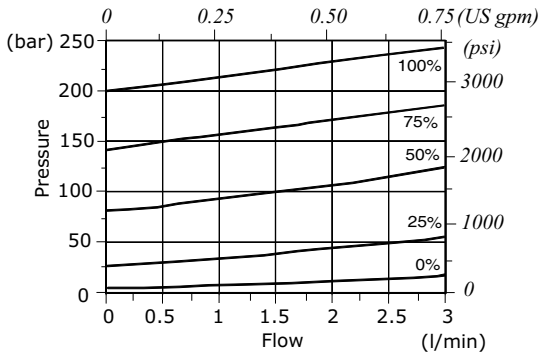





MD..M type shockless pressure relief valve - 2 way

- Direct acting
- Poppet type
- From SAE10 to SAE12 cavities

Technical specifications and diagrams are measured with mineral oil of 46 cSt viscosity at 40°C (104°F) temperature.

	MD10M	MD12M
Nominal flow	60 l/min (15.8 US gpm)	100 l/min (26.4 US gpm)
Max. pressure	350 bar (5100 psi)	
Oil leakage	at 80% of max. pressure setting	5 cm ³ /min (0.3 in ³ /min)
Fluid	mineral based oil	
Viscosity	10-200 cSt	
Max level of contamination	20/18/14 ISO4406	
Fluid temperature	with NBR seals	from -20°C (-4°F) to 80°C (176°F)
Environmental temp. for working conditions	from -20°C (-4°F) to 50°C (122°F)	
Cavity	SAE 10/2	SAE 12/2
Weight	0.200 kg (0.44 lb)	0.355 kg (0.78 lb)

NOTE - For different conditions, please contact Walvoil Sales Dpt.

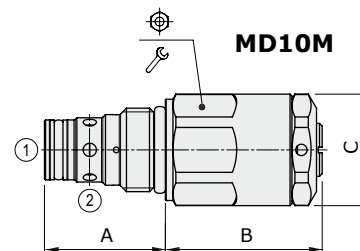
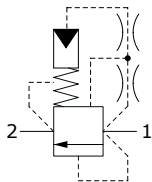

Valve type	A		B		C		⊕	🔧
	mm	in	mm	in	mm	in		
MD10M	32	1.25	73.5	2.89	ø29.5	ø1.16	27	50 37
MD12M	46	1.81	92.5	3.64	ø35	ø1.38	32	80 59

Ordering codes and description composition

MD10M/313B

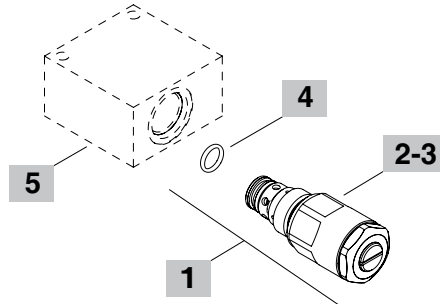
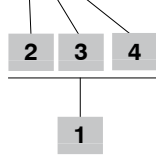

1 Cartridges

TYPE	CODE	DESCRIPTION
SAE cavity 10/2		
MD10M/313B	OMD10002027	Pressure range 13
SAE cavity 12/2		
MD12M/513B	OMD12002004	Pressure range 13

2 Reaction time

TYPE	DESCRIPTION
2	Reaction time 0.2 sec. (± 0.1 sec.)
3	Reaction time 0.3 sec. (± 0.1 sec.)
4	Reaction time 0.4 sec. (± 0.1 sec.)
5	Reaction time 0.5 sec. (± 0.1 sec.)
6	Reaction time 0.6 sec. (± 0.1 sec.)
7	Reaction time 0.7 sec. (± 0.1 sec.)

3 Pressure range

TYPE	DESCRIPTION
SAE cavity 10/2	
11	Pressure range 130÷200 bar (1900÷2900 psi). Pressure ratio 1.9
12	Pressure range 180÷240 bar (2610÷3480 psi). Pressure ratio 2.2
13	Pressure range 220÷290 bar (3190÷4200 psi), Setting 250 bar (3625 psi) at 25 l/min (6.6 US gpm). Pressure ratio 2.4
21	Pressure range 170÷270 bar (2465÷3915 psi). Pressure ratio 2.5
22	Pressure range 220÷290 bar (3190÷4200 psi). Pressure ratio 2.8
SAE cavity 12/2	
11	Pressure range 125÷155 bar (1810÷2250 psi). Pressure ratio 1.7
12	Pressure range 160÷190 bar (2320÷2760 psi). Pressure ratio 1.9
13	Pressure range 180÷240 bar (2610÷3480 psi), Setting 220 bar (3190 psi) at 60 l/min (16 US gpm). Pressure ratio 2.2
21	Pressure range 150÷185 bar (1900÷2685 psi). Pressure ratio 2
22	Pressure range 190÷235 bar (2760÷3400 psi). Pressure ratio 2.35
23	Pressure range 230÷275 bar (3335÷3990 psi). Pressure ratio 2.55

Note: supplied valves are set at the requested pressure and sealed

4 Seals

TYPE	DESCRIPTION
B	NBR (Buna) o-ring seals, std configuration

5 Valve body

TYPE	CODE	DESCRIPTION
SAE 10/2-SAE8	3CC1020K11	Aluminium body for cavity 10 valve, SAE8 std thread
SAE 12/2-SAE10	3CC1220L11	Aluminium body for cavity 12 valve, SAE10 std thread

Note: aluminium body can stand up to 210 bar (3050 psi)
For steel bodies or different threading see from page 215

Rating diagrams

MD10M performance curve example with typical dimensions

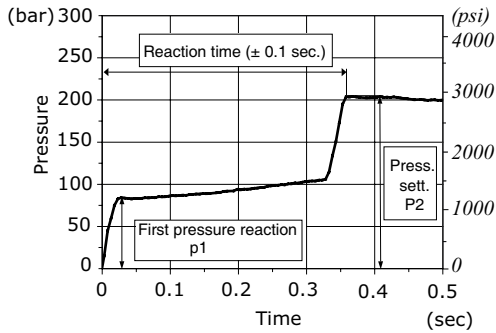

Pressure ratio: $R_p = \frac{p_2}{p_1}$

First pressure reaction: $p_1 = \frac{p_2}{R_p}$

MD10M pressure vs. flow at max. and min. setting

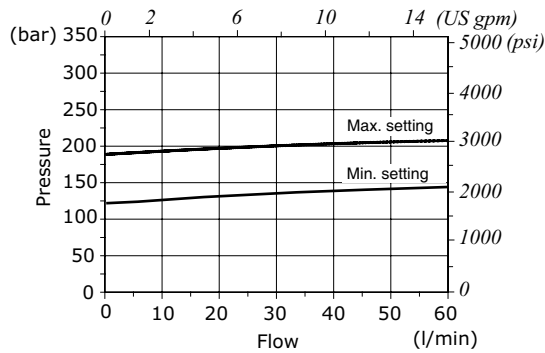

Pressure range 11
130 ÷ 200 bar
(1900 ÷ 2900 psi)
Pressure ratio 1.9
Q=60l/min
(15.8 US gpm)

MD10M performance curve at max. and min. setting

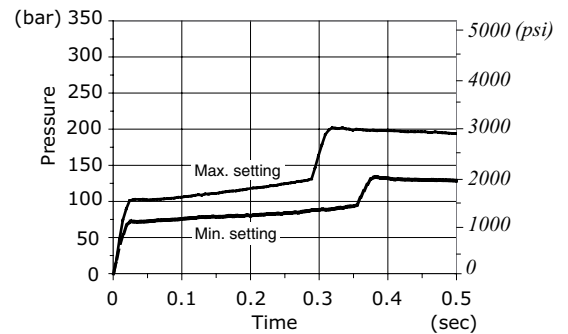

MD10M pressure vs. flow at max. and min. setting

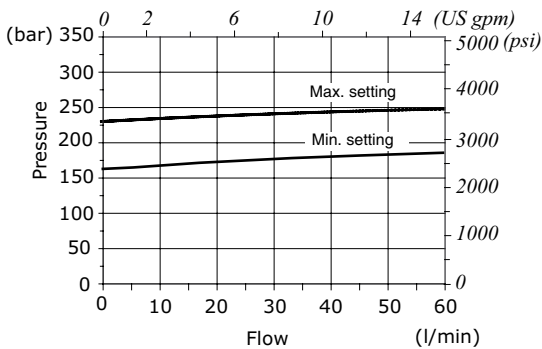

Pressure range 12
180 ÷ 240 bar
(2610 ÷ 3480 psi)
Pressure ratio 2.2
Q=60l/min
(15.8 US gpm)

MD10M performance curve at max. and min. setting

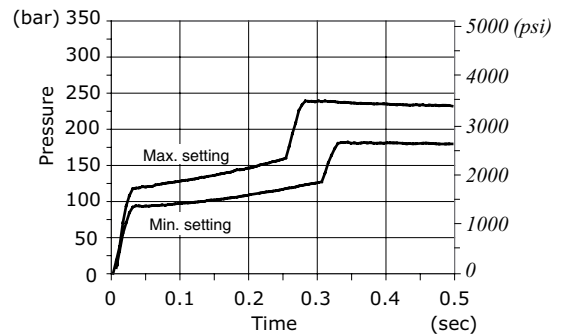

MD10M pressure vs. flow at max. and min. setting

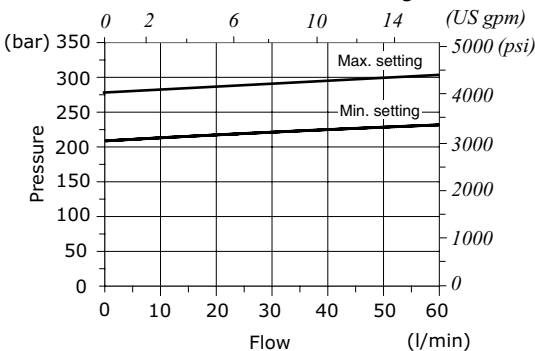

Pressure range 13
220 ÷ 290 bar
(3190 ÷ 4200 psi)
Setting 250 bar (3625 psi) at 25 l/min
(6.6 US gpm)
Pressure ratio 2.4
Q=60l/min
(15.8 US gpm)

MD10M performance curve at max. and min. setting

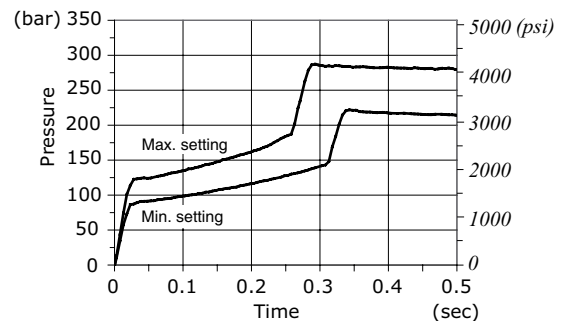

Rating diagrams

MD10M pressure vs. flow
at max. and min. setting

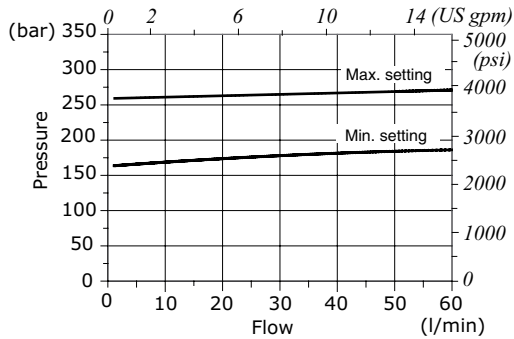

Pressure range
21
170÷270 bar
(2465÷3915 psi)
Pressure ratio 2.5
Q=60l/min
(15.8 US gpm)

MD10M performance curve
at max. and min. setting

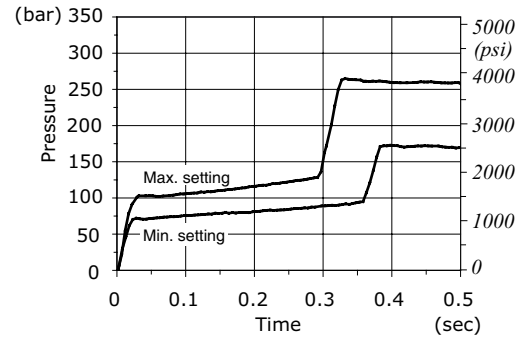

MD10M pressure vs. flow
at max. and min. setting

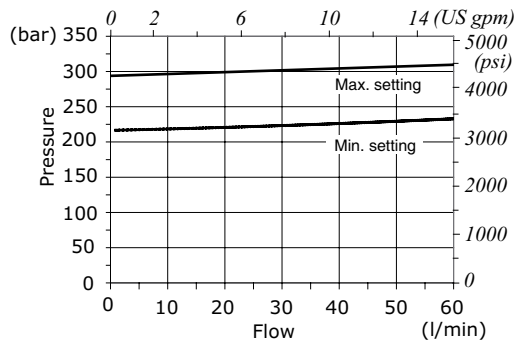

Pressure range
22
220÷290 bar
(3190÷4200 psi)
Pressure ratio 2.8
Q=60l/min
(15.8 US gpm)

MD10M performance curve
at max. and min. setting

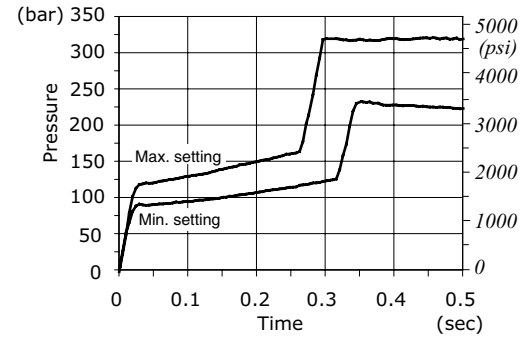

Rating diagrams

MD12M performance curve example with typical dimensions

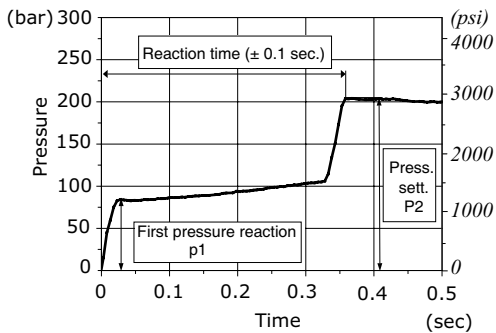

Pressure ratio: $R_p = \frac{p_2}{p_1}$

First pressure reaction: $p_1 = \frac{p_2}{R_p}$

MD12M pressure vs. flow at max. and min. setting

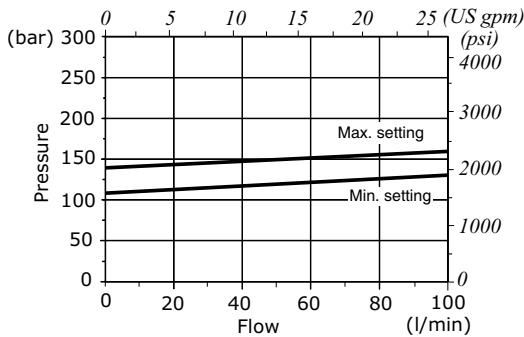

Pressure range 11
125 ÷ 155 bar
(1810 ÷ 2250 psi)
Pressure ratio 1.7
Q=100 l/min
(26.4 US gpm)

MD12M performance curve at max. and min. setting

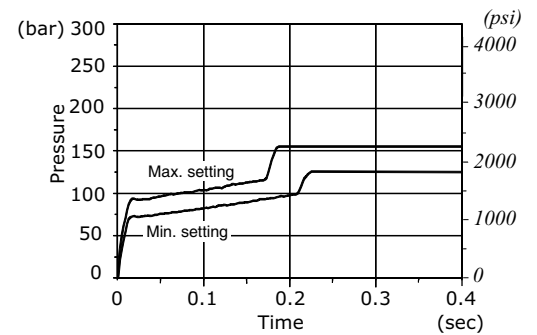

MD12M pressure vs. flow at max. and min. setting

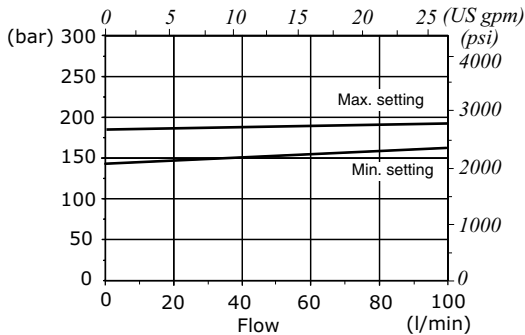

Pressure range 12
160 ÷ 190 bar
(2320 ÷ 2760 psi)
Pressure ratio 1.9
Q=100 l/min
(26.4 US gpm)

MD12M performance curve at max. and min. setting

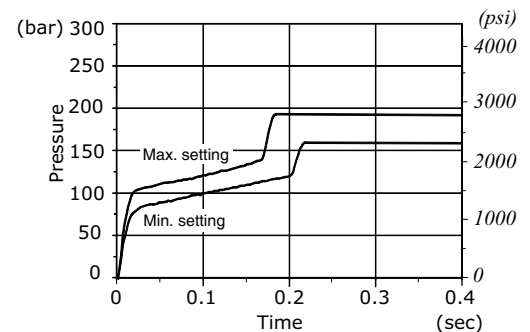

MD12M pressure vs. flow at max. and min. setting

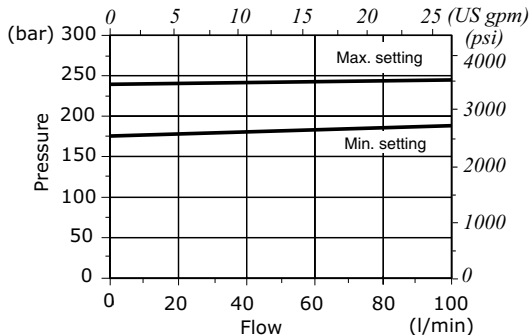

Pressure range 13
180 ÷ 220 bar
(2610 ÷ 3190 psi)
Setting 220 bar (3190 psi) at 60 l/min
(16 US gpm)
Pressure ratio 2.2
Q=100 l/min
(26.4 US gpm)

MD12M performance curve at max. and min. setting

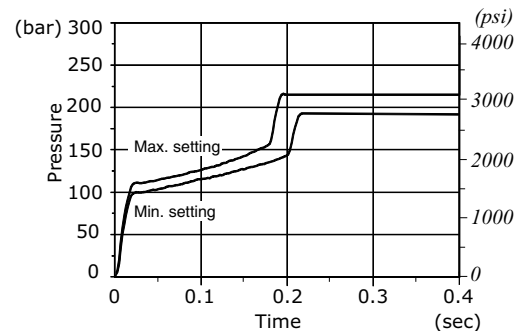

Rating diagrams

MD12M pressure vs. flow
at max. and min. setting

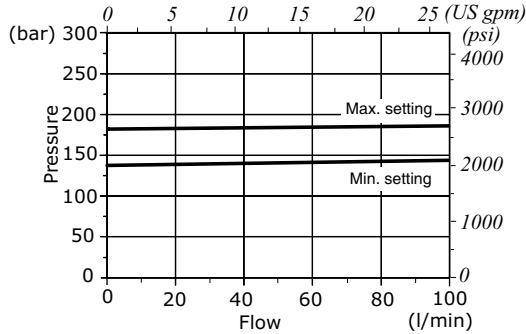

Pressure range 21

150 ÷ 185 bar
(1900 ÷ 2685 psi)
Pressure ratio 2
Q = 100 l/min
(26.4 US gpm)

MD12M performance curve
at max. and min. setting

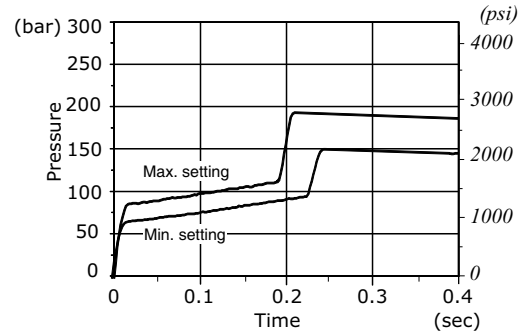

MD12M pressure vs. flow
at max. and min. setting

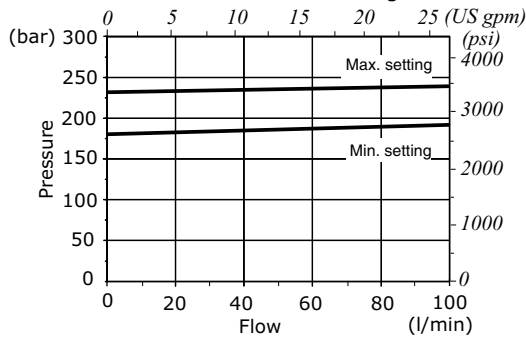

Pressure range 22

190 ÷ 235 bar
(2760 ÷ 3400 psi)
Pressure ratio 2.35
Q = 100 l/min
(26.4 US gpm)

MD12M performance curve
at max. and min. setting

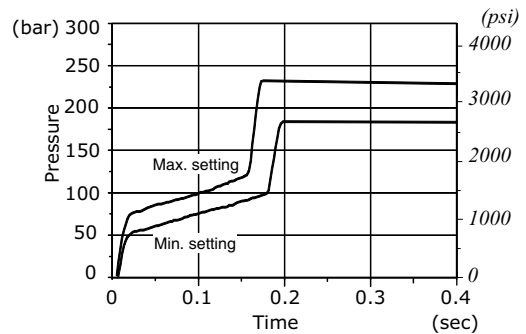

MD12M pressure vs. flow
at max. and min. setting

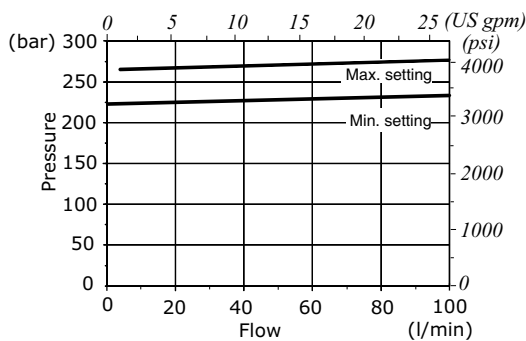

Pressure range 23

230 ÷ 275 bar
(3335 ÷ 3990 psi)
Pressure ratio 2.55
Q = 100 l/min
(26.4 US gpm)

MD12M performance curve
at max. and min. setting

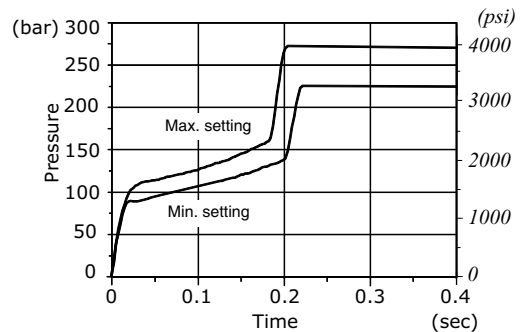



MG..A type pressure relief valve - 2 way

- Differential operated
- Poppet type

Technical specifications and diagrams are measured with mineral oil of 46 cSt viscosity at 40°C (104°F) temperature.

		MG10A	MG12A
Nominal flow		60 l/min (15.8 US gpm)	100 l/min (26.4 US gpm)
Max. pressure		350 bar (5100 psi)	
Oil leakage	80% of max. pressure setting	2 cm ³ /min (0.122 in ³ /min)	
Fluid		mineral based oil	
Viscosity		10-200 cSt	
Max level of contamination		20/18/14 ISO4406	
Fluid temperature	with NBR seals with FPM seals	from -20°C (-4°F) to 80°C (176°F) from -20°C (-4°F) to 100°C (212°F)	
Environmental temp. for working conditions		from -20°C (-4°F) to 50°C (122°F)	
Cavity		SAE 10/2	SAE 12/2
Weight		0.34 kg (0.75 lb)	0.87 kg (1.92 lb)

NOTE - For different conditions, please contact Walvoil Sales Dpt.

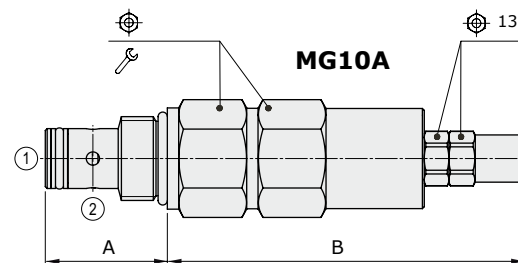
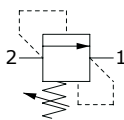

Valve type	A		B		⌀	⌘	
	mm	in	mm	in		Nm	lbft
MG10A/OS	32.3	1.27	94.5	3.72	27	50	37
MG12A/OS	46	1.81	126.5	4.98	36	80	59

For dimensions with different type of adjustment see page 212

Ordering codes and description composition

MG10A/OS1B

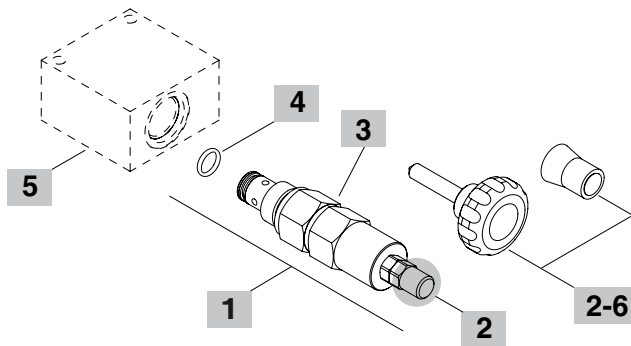
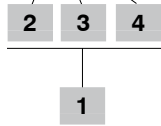

1 Cartridges

TYPE	CODE	DESCRIPTION
SAE cavity 10/2		
MG10A/OS1B	OMG10002009	Pressure range 1
MG10A/OS2B	OMG10002002	Pressure range 2
MG10A/OS3B	OMG10002003	Pressure range 3
MG10A/OS4B	OMG10002001	Pressure range 4
SAE cavity 12/2		
MG12A/OS1B	OMG12002000	Pressure range 1
MG12A/OS2B	OMG12002001	Pressure range 2
MG12A/OS3B	OMG12002002	Pressure range 3

2 Adjustments

TYPE	DESCRIPTION
S	Screw with cap
V	With handwheel (part code: see point 6)
X	Valve set with antitampering cap (part code: see point 6)

3 Pressure range

Standard setting is referred to 5 l/min (1.32 US gpm) flow

TYPE	DESCRIPTION
1	For SAE cavity 10/2: pressure range 30÷100 bar (435÷1450 psi); Std. setting 80 bar (1160 psi) For SAE cavity 12/2: pressure range 20÷100 bar (290÷1450 psi); Std. setting 50 bar (725 psi)
2	Pressure range 50÷200 bar (725÷2900 psi); Std. setting 150 bar (2175 psi)
3	Pressure range 150÷350 bar (2175÷5100 psi); Std. setting 250 bar (3625 psi)
4	Pressure range 5÷60 bar (72.5÷870 psi); Std. setting 30 bar (435 psi), only for SAE cavity 10/2

4 Seals

TYPE	DESCRIPTION
B	NBR (Buna) o-ring seals, std configuration
V	FPM (Viton) o-ring seals, contact Sales Dept.

5 Valve body

TYPE	CODE	DESCRIPTION
SAE 10/2-SAE8	3CC1020K11	Aluminium body for cavity 10 valve, SAE8 std thread
SAE 12/2-SA10	3CC1220L11	Aluminium body for cavity 12 valve, SAE10 std thread

Note: aluminium body can stand up to 210 bar (3050 psi)
For steel bodies or different threading see from page 215

6 Accessories

TYPE	CODE	DESCRIPTION
-	4VL2407100	Handwheel
-	4COP120420	Antitampering cap

Rating diagrams

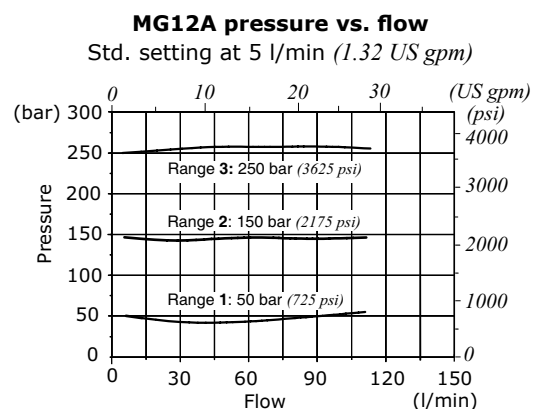
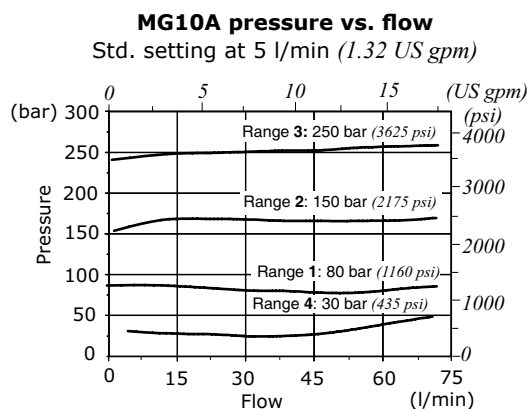



MP..A type pressure relief valves - 2 way

- Pilot operated
- Spool type
- From SAE10 to SAE12 cavities

Technical specifications and diagrams are measured with mineral oil of 46 cSt viscosity at 40°C (104°F) temperature.

	MP10A	MP12A
Nominal flow	60 l/min (16 US gpm)	100 l/min (26.4 US gpm)
Max. pressure	350 bar (5100 psi)	
Oil leakage	80% of max. pressure setting	25 cm ³ /min (1.525 in ³ /min)
Fluid	mineral based oil	
Viscosity	10-200 cSt	
Max level of contamination	20/18/14 ISO4406	
Fluid temperature	with NBR seals with FPM seals	from -20°C (-4°F) to 80°C (176°F) from -20°C (-4°F) to 100°C (212°F)
Environmental temp. for working conditions	from -20°C (-4°F) to 50°C (122°F)	
Cavity	SAE 10/2	SAE 12/2
Weight	0.190 kg (0.42 lb)	0.300 kg (0.661 lb)

NOTE - For different conditions, please contact Walvoil Sales Dpt.

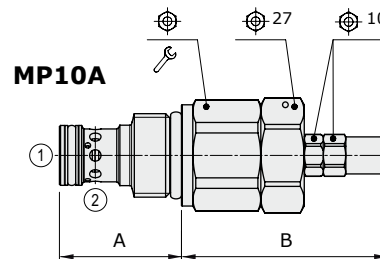
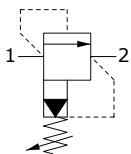

Valve type	A		B		⌀	⌘	Nm	lbft
	mm	in	mm	in				
MP10A/OS	32.3	1.27	54.5	2.15	27	50	37	
MP12A/OS	46	1.81	52.5	2.07	32	80	59	

For dimensions with different type of adjustment see page 212

Ordering codes and description composition

MP10A/OS2B

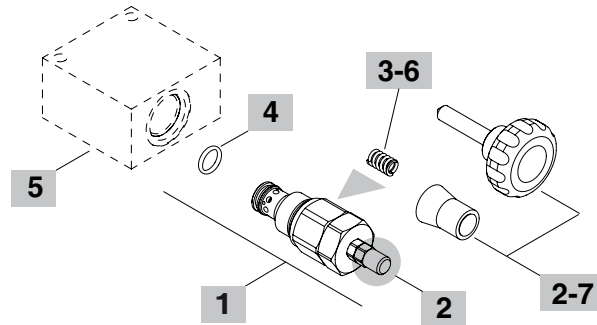
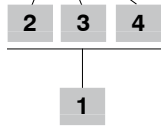

1 Cartridges

TYPE	CODE	DESCRIPTION
MP10A/OS1B	OMP10002017	Pressure range 1
MP10A/OS2B	OMP10002015	Pressure range 2
MP10A/OS3B	OMP10002018	Pressure range 3

SAE cavity 12/2

MP12A/OS1B	OMP12002003	Pressure range 1
MP12A/OS2B	OMP12002000	Pressure range 2
MP12A/OS3B	OMP12002005	Pressure range 3

2 Adjustments

TYPE	DESCRIPTION
S	Screw with cap
V	With handwheel (part code: see point 7)
X	Valve set with antitampering cap (part code: see point 7)

3 Pressure range

TYPE	DESCRIPTION
1	Pressure range 5÷50 bar (72.5÷725 psi)
2	Pressure range 50÷220 bar (725÷3190 psi)
3	Pressure range 150÷350 bar (2175÷5100 psi)

4 Seals

TYPE	DESCRIPTION
B	NBR (Buna) o-ring seals, std configuration
V	FPM (Viton) o-ring seals, contact Sales Dept.

5 Valve body

TYPE	CODE	DESCRIPTION
SAE 10/2-SAE8	3CC1020K11	Aluminium body for cavity 10 valve, SAE8 std thread
SAE 12/2-SAE10	3CC1220L11	Aluminium body for cavity 12 valve, SAE10 std thread

Note: aluminium body can stand up to 210 bar (3050 psi)
For steel bodies or different threading see from page 215

6 Springs

TYPE	CODE	DESCRIPTION
1	3ML1081400	Pressure range 1 - white band
2	3ML1081401	Pressure range 2 - no band
3	3ML1081402	Pressure range 3 - red band

7 Accessories

TYPE	CODE	DESCRIPTION
-	4VL2307007	Handwheel (for MP10A valve)
-	4VL2307001	Handwheel (for MP12A and MP16A valves)
-	4COP116420	Antitampering cap

Rating diagrams

MP10A pressure vs. flow

Std. setting at 5 l/min (1.32 US gpm)

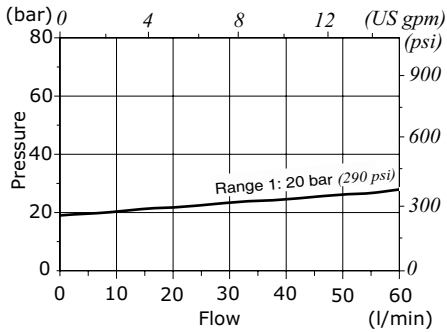

MP10A pressure vs. flow

Std. setting at 5 l/min (1.32 US gpm)

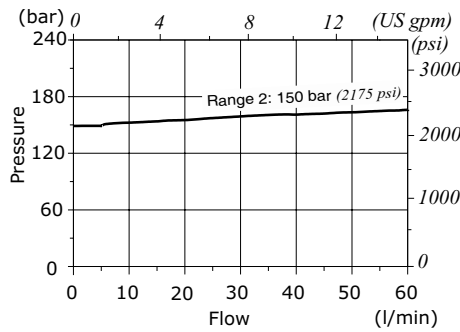

MP10A pressure vs. flow

Std. setting at 5 l/min (1.32 US gpm)

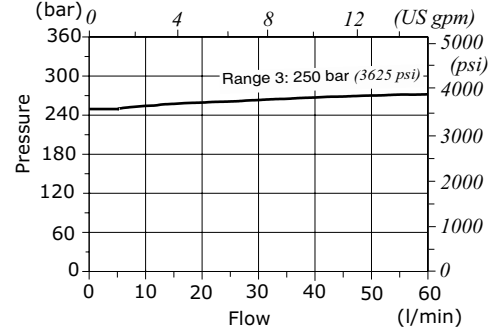

MP12A pressure vs. flow

Std. setting at 5 l/min (1.32 US gpm)

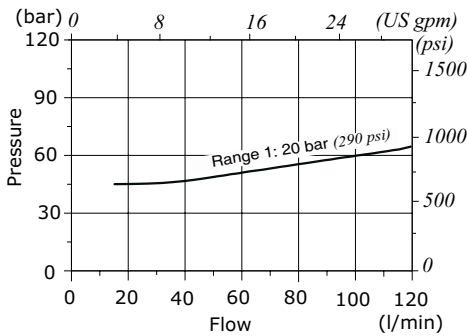

MP12A pressure vs. flow

Std. setting at 5 l/min (1.32 US gpm)

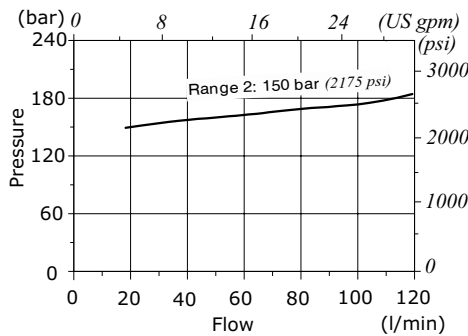

MP12A pressure vs. flow

Std. setting at 5 l/min (1.32 US gpm)

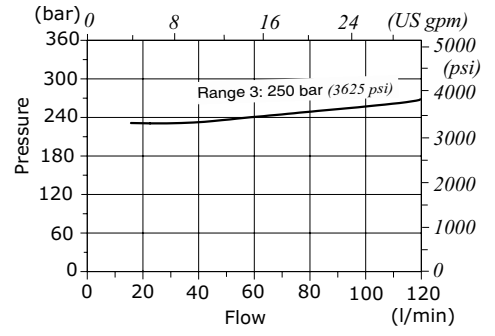





MP16M type pressure relief valve - 2 way

- Pilot operated
- Spool type
- SAE16 cavities

Technical specifications and diagrams are measured with mineral oil of 46 cSt viscosity at 40°C (104°F) temperature.

MP16M		
Nominal flow		400 l/min (105.67 US gpm)
Max. pressure		350 bar (5100 psi)
Oil leakage	80% of max. pressure setting	100 cm ³ /min (6.102 in ³ /min)
Fluid		mineral based oil
Viscosity		12-400 cSt
Max level of contamination		20/18/14 ISO4406
Fluid temperature	with NBR seals with FPM seals	from -20°C (-4°F) to 80°C (176°F) from -20°C (-4°F) to 100°C (212°F)
Environmental temp. for working conditions		from -20°C (-4°F) to 50°C (122°F)
Cavity		SAE 16/2
Weight		0.490 kg (1.080 lb)

NOTE - For different conditions, please contact Walvoil Sales Dpt.

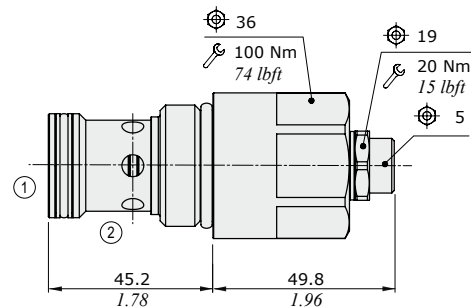
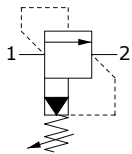

Ordering codes and description composition

MP16M/0Y2B

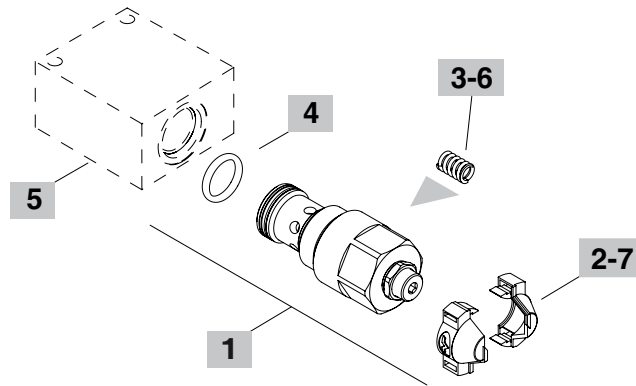
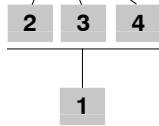

1 Cartridges

TYPE	CODE	DESCRIPTION
SAE cavity 16/2		
MP16M/0Y1B	OMP16002017	Pressure range 1
MP16M/0Y2B	OMP16002013	Pressure range 2
MP16M/0Y3B	OMP16002014	Pressure range 3

2 Adjustments

TYPE	DESCRIPTION
Y	With screw
X	Valve set with antitampering cap (part code: see point 7)

3 Pressure range

TYPE	DESCRIPTION
1	Pressure range 15÷50 bar (217.5÷725 psi)
2	Pressure range 50÷220 bar (725÷3190 psi)
3	Pressure range 150÷350 bar (2175÷5100 psi)

4 Seals

TYPE	DESCRIPTION
B	NBR (Buna) o-ring seals, std configuration
V	FPM (Viton) o-ring seals, contact Sales Dept.

5 Valve body

TYPE	CODE	DESCRIPTION
SAE 16/2-SAE12	3CC1620M11	Steel body for cavity 16 valve, SAE12 std thread

Note: aluminium body can stand up to 210 bar (3050 psi)
For other bodies or different threading see from page 215

6 Springs

TYPE	CODE	DESCRIPTION
1	3ML1081400	Pressure range 1 - white band
2	3ML1081401	Pressure range 2 - no band
3	3ML1081402	Pressure range 3 - red band

7 Accessories

TYPE	CODE	DESCRIPTION
-	4COP126300	Antitampering cap (x2)

Rating diagrams

MP16M pressure vs. flow (range 1)

Std. setting at 5 l/min (1.32 US gpm)

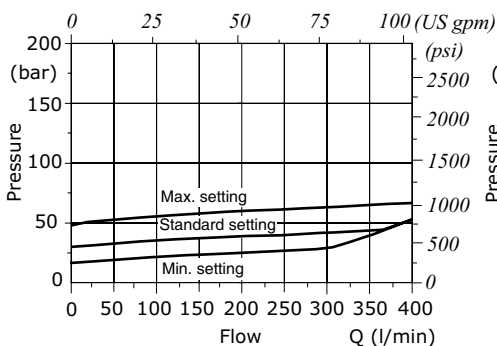

MP16M pressure vs. flow (range 2)

Std. setting at 5 l/min (1.32 US gpm)

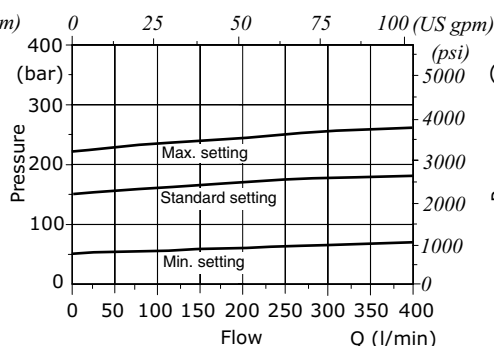

MP16M pressure vs. flow (range 3)

Std. setting at 5 l/min (1.32 US gpm)

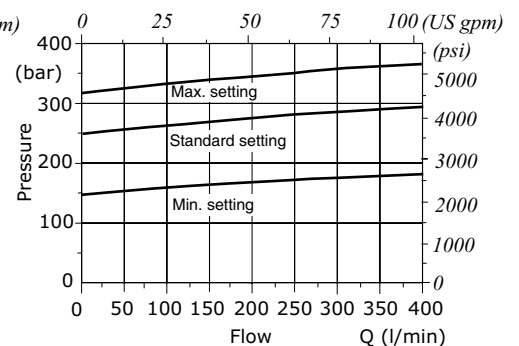



MP..T Type pressure relief valves - 2 way

- Solenoid proportional type, pilot operated
- Decreasing pressure with increasing current (NC)
- Spool type
- From SAE10 to SAE12 cavities

Technical specifications and diagrams are measured with mineral oil of 46 cSt viscosity at 40°C (104°F) temperature.

		MP10T	MP12T
Max. flow		60 l/min (16 US gpm)	120 l/min (31.7 US gpm)
Max. pressure		350 bar (5100 psi)	
Oil leakage	at 80% of max. pressure setting	<150 cm ³ /min (9.15 in ³ /min)	<180 cm ³ /min (<10.1 in ³ /min)
Fluid		mineral based oil	
Viscosity		10-200 cSt	
Max level of contamination		18/16/13 ISO4406	
Fluid temperature	with NBR seals with FPM seals	from -20°C (-4°F) to 80°C (176°F)	from -20°C (-4°F) to 100°C (212°F)
Environmental temp. for working conditions		from -40°C (-40°F) to 100°C (212°F)	
Cavity		SAE 10/2	SAE 12/2
Coil type*		BH or BQP19	
Nominal voltages		12 VDC - 24 VDC	
Power rating		20.4 W (BH) - 15 W (BQP19)	
Max control current		12 V -> 1.70 A - 24 V -> 0.85 A (BH) 12 V -> 1.25 A - 24 V -> 0.63 A (BQP19)	
Dither frequency		200 Hz	200 Hz
Hysteresis		<5%	
Weight		0.77 kg (1.70 lb)	0.92 kg (2.03 lb)

NOTE - For different conditions, please contact Walvoil Sales Dpt. - For coils further features see from page 206.

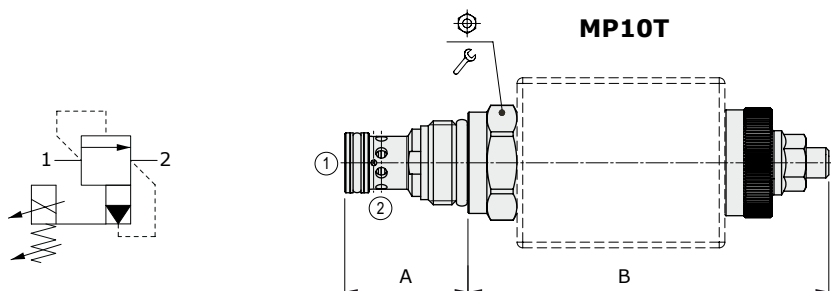

Valve type	A		B		⊕	⌘
	mm	in	mm	in		
MP10T	32.6	1.28	96.5	3.80	27	50 37
MP12T	45	1.81	113	4.45	32	80 59

Ordering codes and description composition

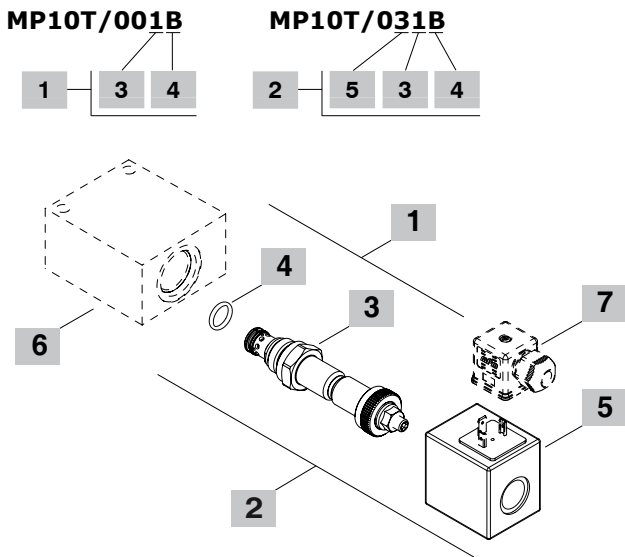

3 Pressure range

TYPE	DESCRIPTION
1	Pressure range 8÷130 bar (116÷1900 psi)
2	Pressure range 8÷180 bar (116÷2600 psi)
3	Pressure range 8÷240 bar (116÷3500 psi)
4	Pressure range 8÷300 bar (116÷4350 psi)

Note: for further pressure range contact Sales Dept.

4 Seals

TYPE	DESCRIPTION
B	NBR (Buna) o-ring seals, std configuration
V	FPM (Viton) o-ring seals, contact Sales Dept.

5 Coils

TYPE	CODE	DESCRIPTION
2) BH 12VDC	4SLD001200	12VDC-ISO4400 coil
3) BQP19 12VDC	4SL5000126	12VDC-ISO4400 coil
4) BH 24VDC	4SLD002400	24VDC-ISO4400 coil
5) BQP19 24VDC	4SL5000245	24VDC-ISO4400 coil

For complete coils list see from page 206

6 Valve body

TYPE	CODE	DESCRIPTION
SAE 10/2-SAE8	3CC1020K11	Aluminium body for cavity 10 valve, SAE8 std thread
SAE 12/2-SAE10	3CC1220L11	Aluminium body for cavity 12 valve, SAE10 std thread

Note: aluminium body can stand up to 210 bar (3050 psi)

For steel bodies or different threading see from page 215

7 Connector

TYPE	CODE	DESCRIPTION
ISO4400	4CN1009995	Connector

For complete connectors list see from page 206

1 Cartridges

TYPE	CODE	DESCRIPTION
SAE cavity 10/2		
MP10T/001B	OMP10002051	Pressure range 1
MP10T/002B	OMP10002052	Pressure range 2
MP10T/003B	OMP10002053	Pressure range 3
SAE cavity 12/2		
MP12T/001B	OMP12002028	Pressure range 1
MP12T/002B	OMP12002029	Pressure range 2
MP12T/003B	OMP12002030	Pressure range 3
MP12T/004B	OMP12002035	Pressure range 4

2 Complete cartridges

TYPE	CODE	DESCRIPTION
SAE cavity 10/2		
MP10T/031B	OMP10002035	Pressure range 1 , 12VDC
MP10T/032B	OMP10002036	Pressure range 2 , 12VDC
MP10T/033B	OMP10002037	Pressure range 3 , 12VDC
SAE cavity 12/2		
MP12T/031B	OMP12002020	Pressure range 1 , 12VDC
MP12T/032B	OMP12002021	Pressure range 2 , 12VDC
MP12T/033B	OMP12002022	Pressure range 3 , 12VDC
MP12T/034B	OMP12002027	Pressure range 4 , 12VDC

Rating diagrams

MP10T pressure setting vs. % max. control current
at 5 l/min (1.32 US gpm)

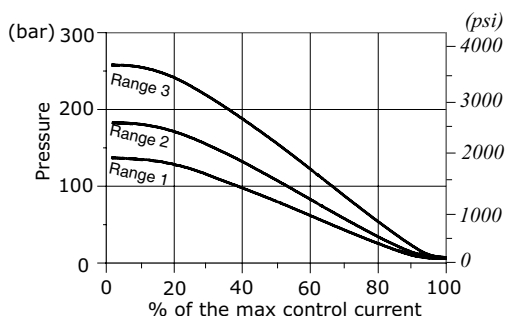

MP10T pressure vs. flow 1->2
for % of control current - Pressure range 1 -

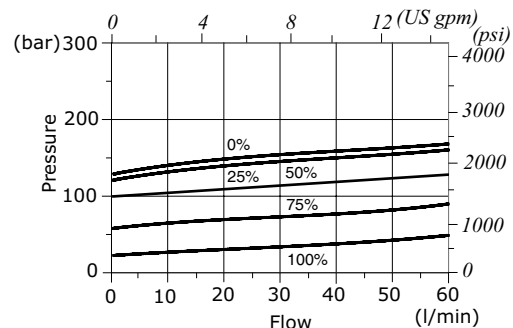

Rating diagrams

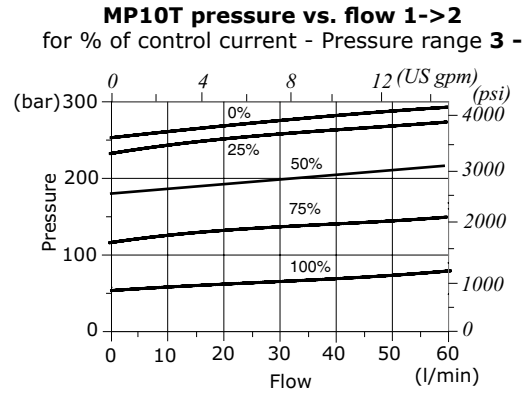
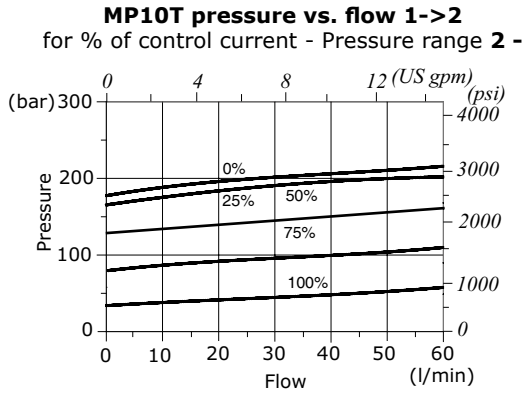

MP12T pressure setting vs. % max. control current
at 10 l/min (2.6 US gpm)

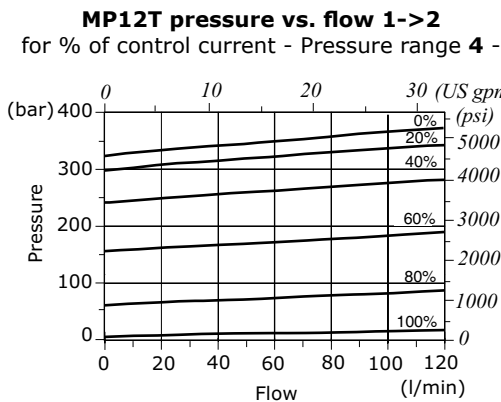
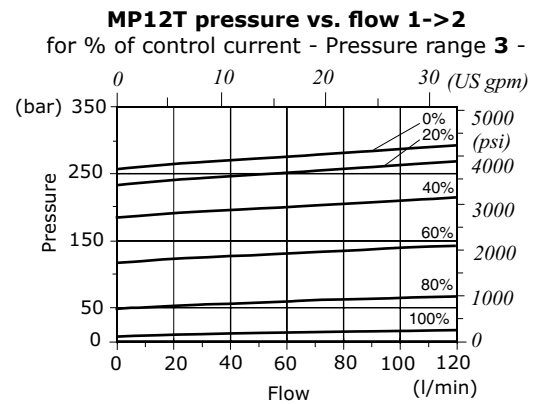
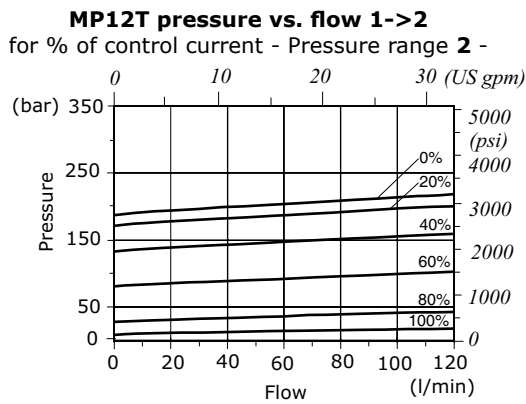
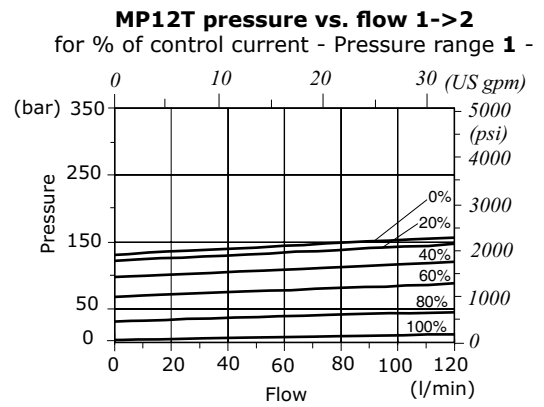
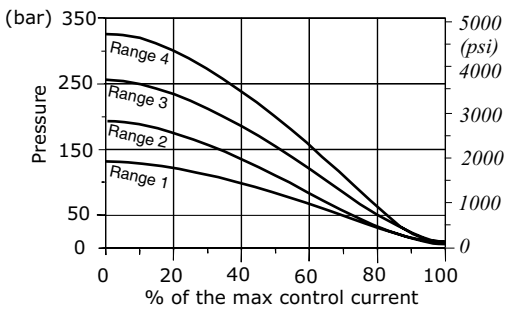





MP..X type pressure relief valves - 2 way

- Solenoid proportional type, pilot operated
- Increasing pressure with increasing current (NO)
- Spool type
- From SAE10 to SAE12 cavities

Technical specifications and diagrams are measured with mineral oil of 46 cSt viscosity at 40°C (104°F) temperature.

		MP10X	MP12X
Max. flow		60 l/min (16 US gpm)	120 l/min (31.7 US gpm)
Max. pressure		350 bar (5100 psi)	
Oil leakage	at 80% of max. pressure setting	<150 cm ³ /min (9.15 in ³ /min)	<180 cm ³ /min (10.1 in ³ /min)
Fluid		mineral based oil	
Viscosity		10-200 cSt	
Max level of contamination		18/16/13 ISO4406	
Fluid temperature	with NBR seals with FPM seals	from -20°C (-4°F) to 80°C (176°F) from -20°C (-4°F) to 100°C (212°F)	
Environmental temp. for working conditions		from -40°C (-40°F) to 100°C (212°F)	
Cavity		SAE 10/2	SAE 12/2
Coil type*		BH or BQP19	
Nominal voltages		12 VDC - 24 VDC	
Power rating		20.4 W (BH) - 15 W (BQP19)	
Max control current		12 V -> 1.70 A - 24 V -> 0.85 A (BH) 12 V -> 1.25 A - 24 V -> 0.63 A (BQP19)	
Dither frequency		180 Hz	180 Hz
Hysteresis		<5%	
Weight		0.76 kg (1.67 lb)	0.88 kg (1.94 lb)

NOTE - For different conditions, please contact Walvoil Sales Dpt. - For coils further features see from page 206.

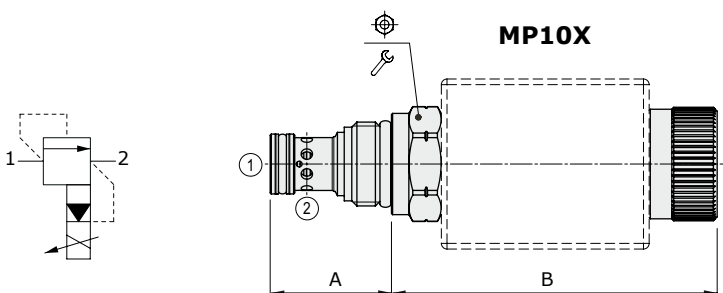

Valve type	A		B		⌀	⌘	Nm	lbft
	mm	in	mm	in				
MP10X/0	32.3	1.27	86	3.39	27	50	37	
MP12X/0	45	1.81	102	4.02	32	80	59	

For dimensions with different type of emergency see page 213

Ordering codes and description composition

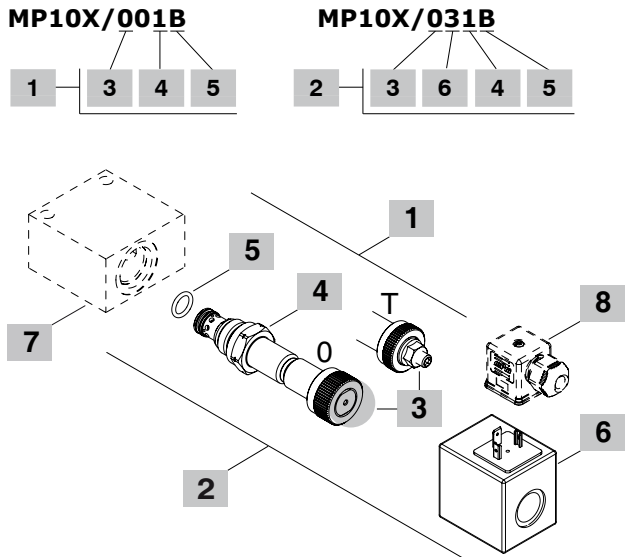

3 Emergency

TYPE	DESCRIPTION
O	Without override
T	With screw

4 Pressure range

TYPE	DESCRIPTION
1	Pressure range 10÷120 bar (145÷1740 psi)
2	Pressure range 10÷160 bar (145÷2320 psi)
3	Pressure range 10÷230 bar (145÷3335 psi)
4	Pressure range 10÷350 bar (145÷5100 psi)

Note: for further pressure range contact Sales Dept.

5 Seals

TYPE	DESCRIPTION
B	NBR (Buna) o-ring seals, std configuration
V	FPM (Viton) o-ring seals, contact Sales Dept.

6 Coils

TYPE	CODE	DESCRIPTION
2) BH 12VDC	4SLD001200	12VDC-ISO4400 coil
3) BQP19 12VDC	4SL5000126	12VDC-ISO4400 coil
4) BH 24VDC	4SLD002400	24VDC-ISO4400 coil
5) BQP19 24VDC	4SL5000245	24VDC-ISO4400 coil

For complete coils list see from page 206

7 Valve body

TYPE	CODE	DESCRIPTION
SAE 10/2-SAE8	3CC1020K11	Aluminium body for cavity 10 valve, SAE8 std thread
SAE 12/2-SAE10	3CC1220L11	Aluminium body for cavity 12 valve, SAE10 std thread

Note: aluminium body can stand up to 210 bar (3050 psi)
For steel bodies or different threading see from page 215

8 Connector

TYPE	CODE	DESCRIPTION
ISO4400	4CN1009995	Connector

For complete connectors list see from page 206

1 Cartridges

TYPE	CODE	DESCRIPTION
SAE cavity 10/2		
MP10X/001B	OMP10002054	Pressure range 1
MP10X/002B	OMP10002055	Pressure range 2
MP10X/003B	OMP10002056	Pressure range 3
MP10X/004B	OMP10002057	Pressure range 4
SAE cavity 12/2		
MP12X/001B	OMP12002031	Pressure range 1
MP12X/002B	OMP12002032	Pressure range 2
MP12X/003B	OMP12002033	Pressure range 3
MP12X/004B	OMP12002034	Pressure range 4

2 Complete cartridges

TYPE	CODE	DESCRIPTION
SAE cavity 10/2		
MP10X/031B	OMP10002044	Pressure range 1 , 12VDC
MP10X/032B	OMP10002045	Pressure range 2 , 12VDC
MP10X/033B	OMP10002046	Pressure range 3 , 12VDC
MP10X/034B	OMP10002047	Pressure range 4 , 12VDC
SAE cavity 12/2		
MP12X/031B	OMP12002023	Pressure range 1 , 12VDC
MP12X/032B	OMP12002024	Pressure range 2 , 12VDC
MP12X/033B	OMP12002025	Pressure range 3 , 12VDC
MP12X/034B	OMP12002026	Pressure range 4 , 12VDC

Rating diagrams

MP10X pressure setting vs. % max. control current
at 5 l/min (1.32 US gpm)

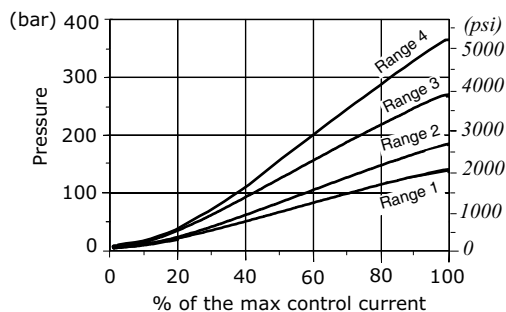

MP10X pressure vs. flow 1->2
for % of control current - Pressure range 1 -

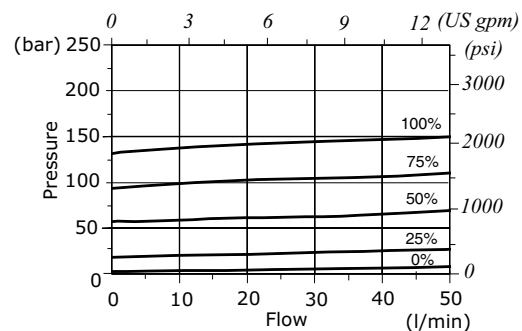

Rating diagrams

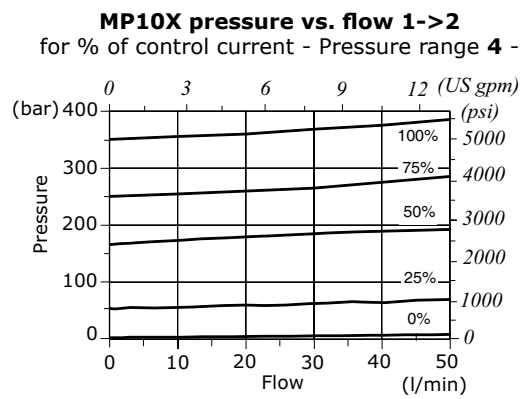
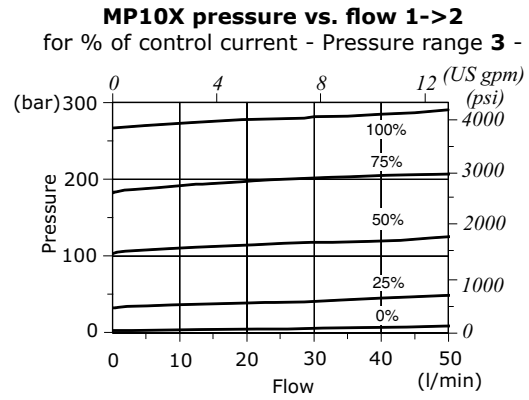
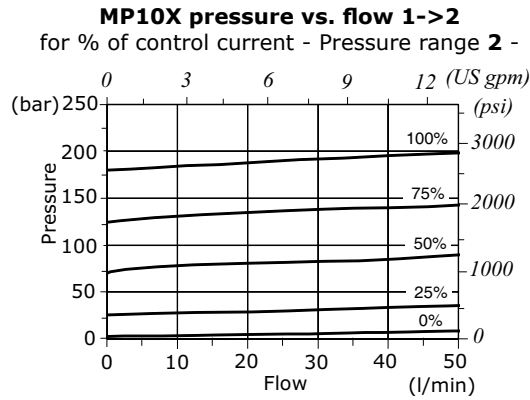

MP12X pressure setting vs. % max. control current
at 10 l/min (2.64 US gpm)

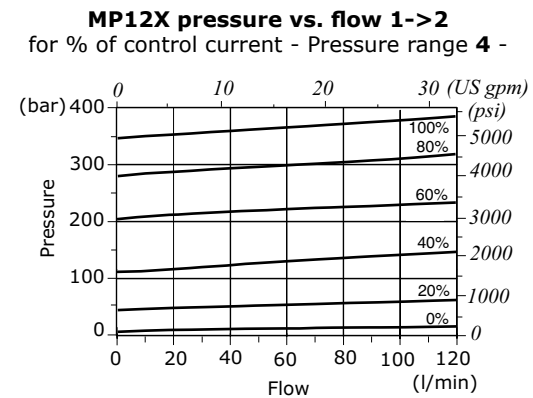
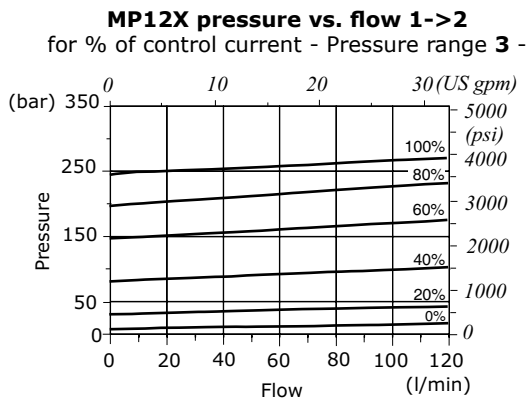
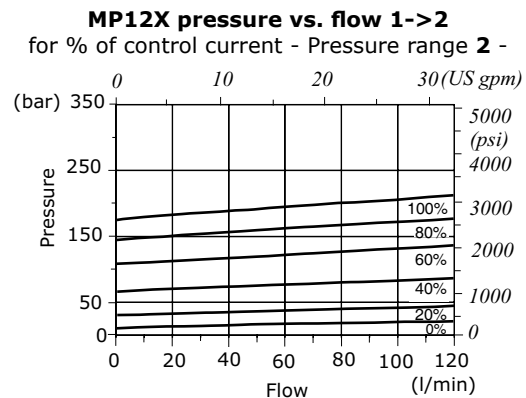
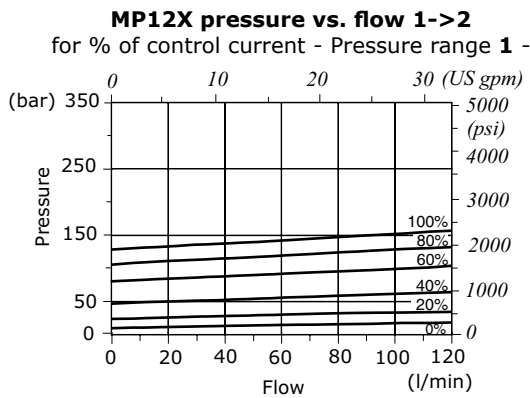
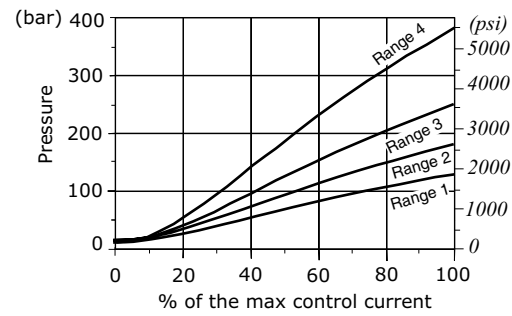





MP16Y type pressure relief valve - 2 way

- Solenoid proportional type, pilot operated
- Increasing pressure with increasing current (NO)
- Spool type

Technical specifications and diagrams are measured with mineral oil of 46 cSt viscosity at 40°C (104°F) temperature.

MP16Y		
Nominal flow		5 l/min (1.32 US gpm)
Max. flow		150 l/min (40 US gpm)
Max. pressure		Line 1=350 bar (5100 psi); Line 2=210 bar (3045 psi)
Oil leakage	80% of max. pressure setting	200 cm ³ /min (12.20 in ³ /min)
Fluid		mineral based oil
Viscosity		10-200 cSt
Max level of contamination		18/16/13 ISO4406
Fluid temperature	with NBR seals with FPM seals	from -20°C (-4°F) to 80°C (176°F) from -20°C (-4°F) to 100°C (212°F)
Environmental temp. for working conditions		from -40°C (-40°F) to 100°C (212°F)
Cavity		SAE 16/2
Coil type*		MP35
Nominal voltages		12 VDC - 24VDC
Power rating		11.2 W (12 VDC) - 11.4 W (24 VDC)
Max control current		12 V -> 1.25 A - 24 V -> 0.68 A
Dither frequency		150 Hz
Hysteresis		≤4%
Weight		0.96 kg (2.11 lb)

NOTE - For different conditions, please contact Walvoil Sales Dpt. - For coils further features see from page 206.

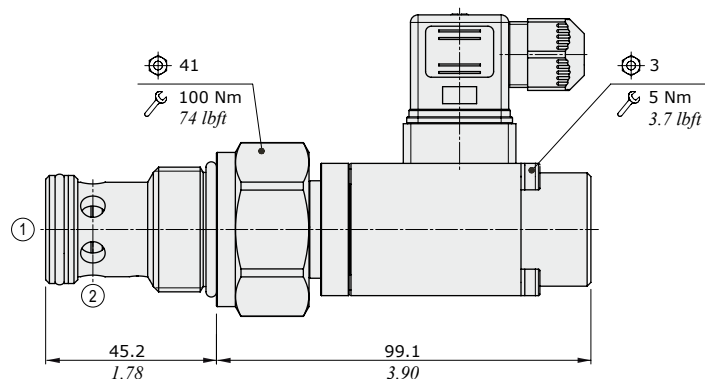
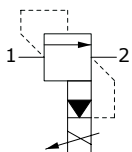

Ordering codes and description composition

MP16Y/021B

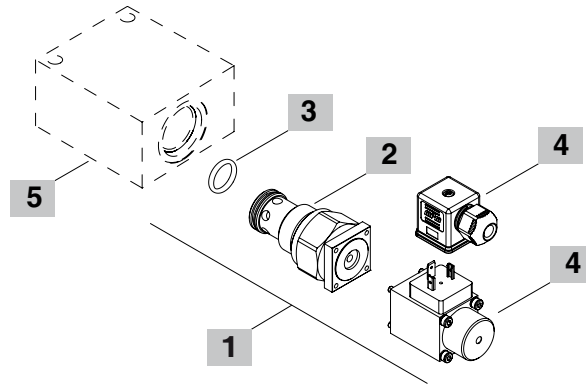
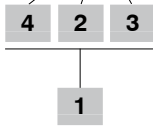

1 Cartridges

TYPE	CODE	DESCRIPTION
MP16Y/021B	OMP16002007	Pressure range 1 , 12VDC
MP16Y/022B	OMP16002002	Pressure range 2 , 12VDC
MP16Y/023B	OMP16002009	Pressure range 3 , 12VDC
MP16Y/024B	OMP16002011	Pressure range 4 , 12VDC

2 Pressure range

TYPE	DESCRIPTION
1	Pressure range 10÷100 bar (145÷1450 psi)
2	Pressure range 50÷200 bar (725÷2900 psi)
3	Pressure range 80÷350 bar (1160÷5100 psi)
4	Pressure range 5÷40 bar (72.5÷580 psi)

3 Seals

TYPE	DESCRIPTION
B	NBR (Buna) o-ring seals, std configuration
V	FPM (Viton) o-ring seals, contact Sales Dept.

4 Coils and connectors

TYPE	CODE	DESCRIPTION
2) MP35 12VDC ISO4400	5SL4000120 4CN1009995	12VDC-ISO4400 coil Connector
4) MP35 24VDC ISO4400	4SL4000240 4CN1009995	24VDC-ISO4400 coil Connector

For complete coils and connectors list see from page 206

5 Valve body

TYPE	CODE	DESCRIPTION
SAE 16/2-SAE12	3CC1620M11	Aluminium body for cavity 16 valve, SAE12 std thread

Note: aluminium body can stand up to 210 bar (3050 psi)

For steel bodies or different threading see from page 215

Rating diagrams

Pressure setting vs. % max. control current
at 5 l/min (1.32 US gpm)

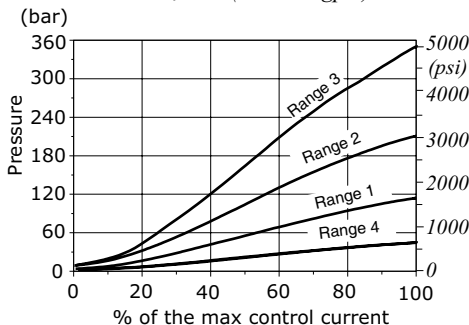

Pressure vs. flow 1->2
with de-energized coil

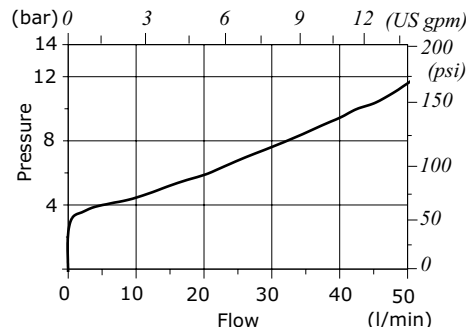

Pressure vs. flow 1->2
for % of control current - Pressure range 2 -

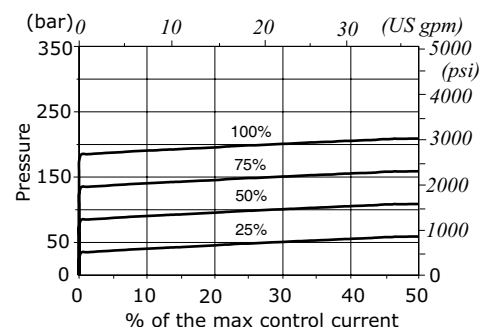



RB..A type pressure reducing valves - 3 way

- Direct acting
- Without relieving
- Spool type
- From SAE08 to SAE10 cavities

Technical specifications and diagrams are measured with mineral oil of 46 cSt viscosity at 40°C (104°F) temperature.

	RB08A	RB10A
Nominal flow	8 l/min (0.3 US gpm)	30 l/min (7.9 US gpm)
Max. pressure		line 1=150 bar (2175 psi) line 2=350 bar (5100 psi)
Oil leakage	at 100 bar (1450 psi)	10 cm ³ /min (0.61 in ³ /min) 40 cm ³ /min (2.44 in ³ /min)
Fluid		mineral based oil
Viscosity		10-200 cSt
Max level of contamination		20/18/14 ISO4406
Fluid temperature	with NBR seals with FPM seals	from -20°C (-4°F) to 80°C (176°F) from -20°C (-4°F) to 100°C (212°F)
Environmental temp. for working conditions		from -20°C (-4°F) to 50°C (122°F)
Cavity	SAE 08/3	SAE 10/3
Weight	0.240 kg (0.53 lb)	0.360 kg (0.79 lb)

NOTE - For different conditions, please contact Walvoil Sales Dpt.

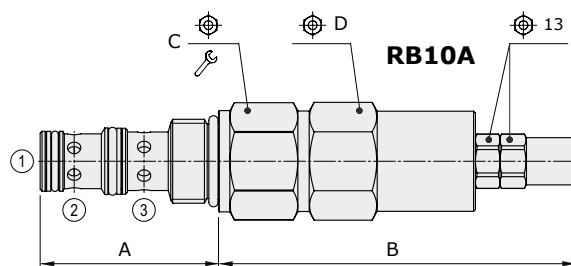
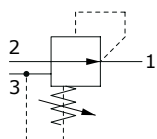

Valve type	A		B		C	D	Nm	lbft
	mm	in	mm	in				
RB08A/OS	40.8	1.60	79.5	3.13	24	24	30	22
RB10A/OS	47.2	1.86	94.5	3.72	27	27	50	37

For dimensions with different type of adjustment see page 212

Ordering codes and description composition

RB08A/0S2B

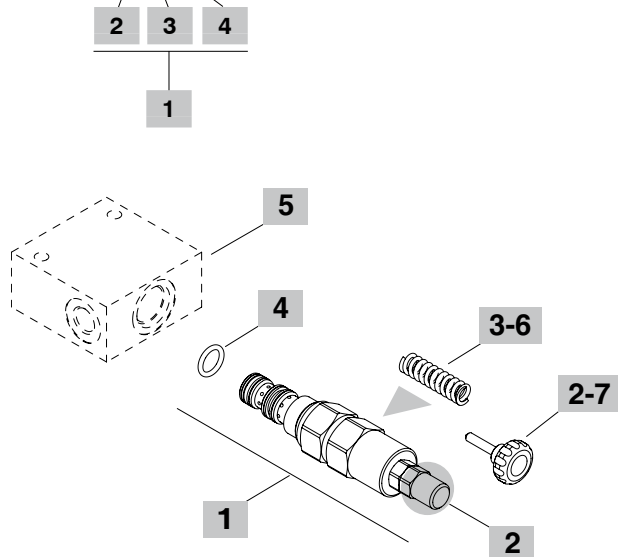

3 Pressure range

Standard setting is referred to at 5 l/min (1.32 US gpm) flow

TYPE	DESCRIPTION
1	Pressure range 5÷50 bar (72.5÷725 psi); Std. setting 30 bar (435 psi)
2	Pressure range 20÷100 bar (290÷1450 psi); Std. setting 50 bar (725 psi)
3	Pressure range 50÷150 bar (725÷2175 psi); Std. setting 100 bar (1450 psi)

4 Seals

TYPE	DESCRIPTION
B	NBR (Buna) o-ring seals, std configuration
V	FPM (Viton) o-ring seals, contact Sales Dept.

5 Valve body

TYPE	CODE	DESCRIPTION
SAE 08/3-SAE6	3CC0830J11	Aluminium body for cavity 08 valve, SAE6 std thread
SAE 10/3-SAE8	3CC1030K11	Aluminium body for cavity 10 valve, SAE8 std thread

Note: aluminium body can stand up to 210 bar (3050 psi)
For steel bodies or different threading see from page 217

6 Springs

TYPE	CODE	DESCRIPTION
SAE cavity 08/3		
1	3ML1103600	Pressure range 1 - no band
2	3ML1103601	Pressure range 2 - no band
3	3ML1104000	Pressure range 3 - no band
SAE cavity 10/3		
1	3ML1144601	Pressure range 1 - green band
2	3ML1144602	Pressure range 2 - blue band
3	3ML1144603	Pressure range 3 - red band

7 Accessories

TYPE	CODE	DESCRIPTION
-	4VL2407100	handwheel

1 Cartridges

TYPE	CODE	DESCRIPTION
SAE cavity 08/3		
RB08A/0S1B	0RB08002002	Screw adjustment, pressure range 1
RB08A/0S2B	0RB08002000	Screw adjustment, pressure range 2
SAE cavity 10/3		
RB10A/0S1B	0RB10002002	Screw adjustment, pressure range 1
RB10A/0S2B	0RB10002001	Screw adjustment, pressure range 2

2 Adjustments

TYPE	DESCRIPTION
S	Screw
V	With handwheel see point 7

Rating diagrams

RB08A pressure reducing vs. flow 2->1

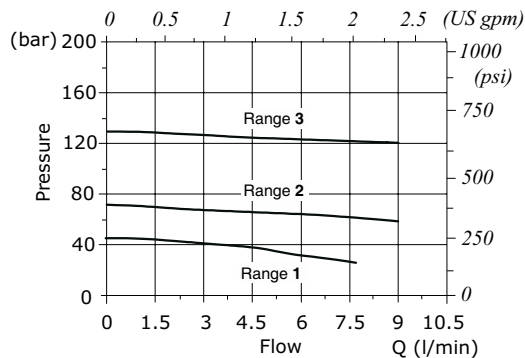

RB10A pressure reducing vs. flow 2->1

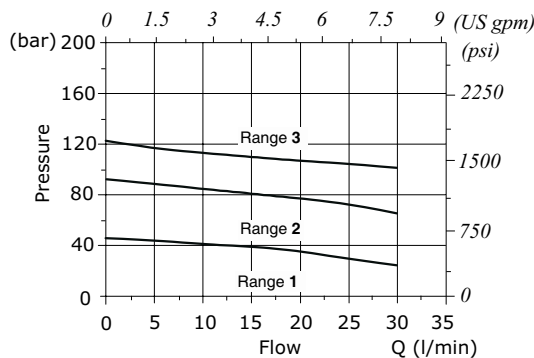



RD..A type pressure reducing valves - 3 way

- Direct acting
- With relieving
- Spool type
- From SAE08 to SAE10 cavities

Technical specifications and diagrams are measured with mineral oil of 46 cSt viscosity at 40°C (104°F) temperature.

	RD08A	RD10A
Nominal flow	8 l/min (2.1 US gpm)	30 l/min (7.9 US gpm)
Max. pressure		line 1=150 bar (2175 psi) line 2=350 bar (5100 psi)
Oil leakage at 100 bar (1450 psi)	10 cm ³ /min (0.61 in ³ /min)	40 cm ³ /min (2.44 in ³ /min)
Fluid		mineral based oil
Viscosity		10-200 cSt
Max level of contamination		20/18/14 ISO4406
Fluid temperature	with NBR seals with FPM seals	from -20°C (-4°F) to 80°C (176°F) from -20°C (-4°F) to 100°C (212°F)
Environmental temp. for working conditions		from -20°C (-4°F) to 50°C (122°F)
Cavity	SAE 08/3	SAE 10/3
Weight	0.240 kg (0.53 lb)	0.360 kg (0.79 lb)

NOTE - For different conditions, please contact Walvoil Sales Dpt.

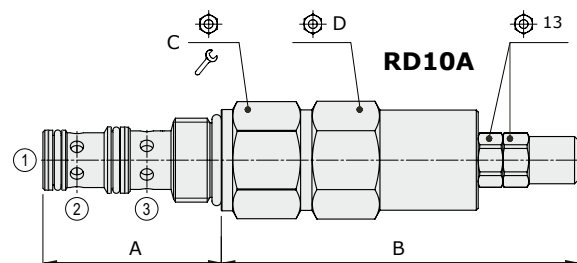
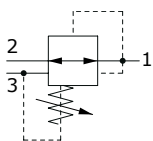

Valve type	A		B		C	D	⌘	
	mm	in	mm	in			Nm	lbft
RD08A/OS	40.8	1.60	79.5	3.13	24	24	30	22
RD10A/OS	47.2	1.86	94.5	3.72	27	27	50	37

For dimensions with different type of adjustment see page 212

Ordering codes and description composition

RD08A/0S2B

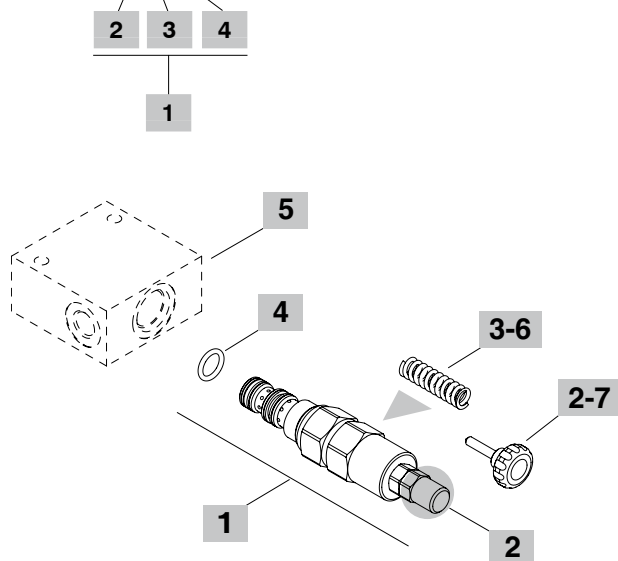

4 Pressure range

Standard setting is referred to at 5 l/min (1.32 US gpm) flow

TYPE	DESCRIPTION
1	Pressure range 5÷50 bar (72.5÷725 psi); Std. setting 30 bar (435 psi)
2	Pressure range 20÷100 bar (290÷1450 psi); Std. setting 50 bar (725 psi)
3	Pressure range 50÷150 bar (725÷2175 psi); Std. setting 100 bar (1450 psi)

4 Seals

TYPE	DESCRIPTION
B	NBR (Buna) o-ring seals, std configuration
V	FPM (Viton) o-ring seals, contact Sales Dept.

5 Valve body

TYPE	CODE	DESCRIPTION
SAE 08/3-SAE6	3CC0830J11	Aluminium body for cavity 08 valve, SAE6 std thread
SAE 10/3-SAE8	3CC1030K11	Aluminium body for cavity 10 valve, SAE8 std thread

Note: aluminium body can stand up to 210 bar (3050 psi)
For steel bodies or different threading see page 217

6 Springs

TYPE	CODE	DESCRIPTION
SAE cavity 08/3		
1	3ML1103600	Pressure range 1 - no band
2	3ML1103601	Pressure range 2 - no band
3	3ML1104000	Pressure range 3 - no band
SAE cavity 10/3		
1	3ML1144601	Pressure range 1 - green band
2	3ML1144602	Pressure range 2 - blue band
3	3ML1144603	Pressure range 3 - red band

7 Accessories

TYPE	CODE	DESCRIPTION
-	4VL2407100	handwheel

1 Cartridges

TYPE	CODE	DESCRIPTION
SAE cavity 08/3		
RD08A/0S1B	ORD08002003	Screw adjustment, pressure range 1
RD08A/0S2B	ORD08002005	Screw adjustment, pressure range 2
RD08A/0S3B	ORD08002000	Screw adjustment, pressure range 3

SAE cavity 10/3

RD10A/0S1B	ORD10002003	Screw adjustment, pressure range 1
RD10A/0S2B	ORD10002001	Screw adjustment, pressure range 2
RD10A/0S3B	ORD10002000	Screw adjustment, pressure range 3

3 Adjustments

TYPE	DESCRIPTION
S	Screw
V	With handwheel see point 7

Rating diagrams

RD08A reducing/relieving pressure vs. flow

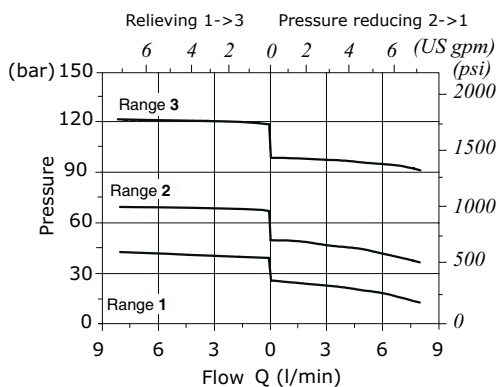

RD10A reducing/relieving pressure vs. flow

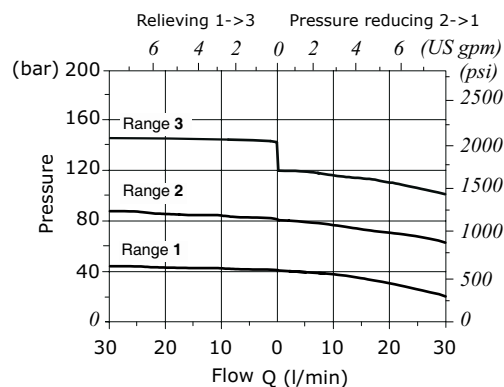



RD08W type pressure reducing valve - 3 way

- Solenoid proportional type, direct acting
- With relieving (NO)
- Spool type

Technical specifications and diagrams are measured with mineral oil of 46 cSt viscosity at 40°C (104°F) temperature.

		RD08W
Nominal flow		4 l/min (1.05 US gpm)
Max. pressure		350 bar (5100 psi)
Oil leakage		-
Fluid		mineral based oil
Viscosity		10-200 cSt
Max level of contamination		18/16/13 ISO4406
Fluid temperature	<i>with NBR seals</i>	from -20°C (-4°F) to 80°C (176°F)
	<i>with FPM seals</i>	from -20°C (-4°F) to 100°C (212°F)
Environmental temp. for working conditions		from -40°C (-40°F) to 100°C (212°F)
Cavity		SAE 08/3
Coil type*		MP35
Nominal voltages		12 VDC - 24 VDC
Power rating		11.2 W (12 VDC) - 11.4 W (24 VDC)
Max control current		12 V -> 1.25 A - 24 V -> 0.68 A
Dither frequency		150 Hz
Hysteresis		≤4%
Weight		0.680 kg (1.50 lb)

NOTE - For different conditions, please contact Walvoil Sales Dpt. - For coils further features see from page 206.

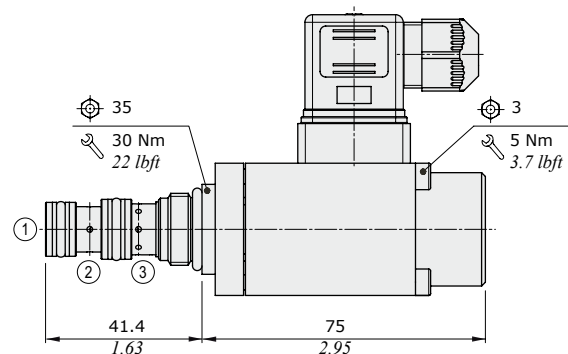
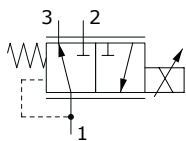

Ordering codes and description composition

RD08W/021B

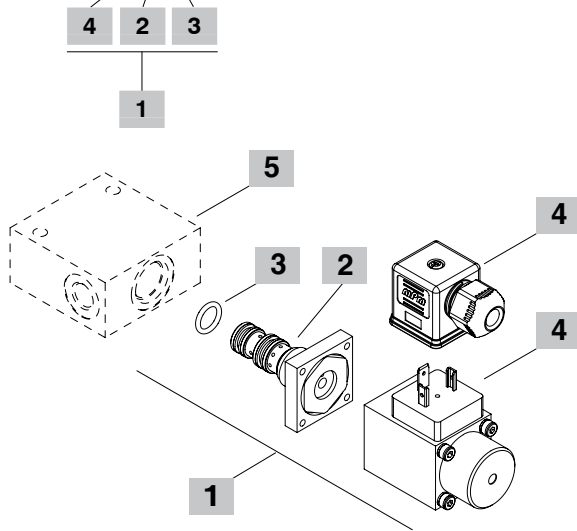

2 Pressure range

TYPE	DESCRIPTION
1	Pressure range 5÷25 bar (72.5÷363 psi)
2	Pressure range 0÷12 bar (0÷174 psi)

3 Seals

TYPE	DESCRIPTION
B	NBR (Buna) o-ring seals, std configuration
V	FPM (Viton) o-ring seals, contact Sales Dept.

4 Coils and connectors

TYPE	CODE	DESCRIPTION
2) MP35 12VDC	5SL4000120	12VDC-ISO4400 coil
ISO4400	4CN1009995	Connector
4) MP35 24VDC	4SL4000240	24VDC-ISO4400 coil
ISO4400	4CN1009995	Connector

For complete coils and connectors list see from page 206

5 Valve body

TYPE	CODE	DESCRIPTION
SAE 08/3-SAE6	3CC0830J11	Aluminium body for cavity 08 valve, SAE6 std thread

Note: aluminium body can stand up to 210 bar (3050 psi)

For steel bodies or different threading see from page 217

1 Cartridges

TYPE	CODE	DESCRIPTION
RD08W/021B	ORD08002001	Pressure range 1 , 12VDC

Rating diagrams

Pressure drop vs. flow 2->1
Pressure range **1**

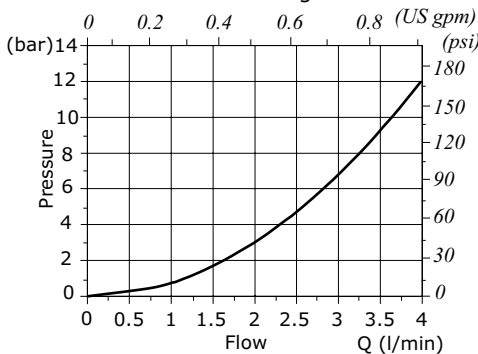

Pressure drop vs. flow 1->2
Pressure range **1**

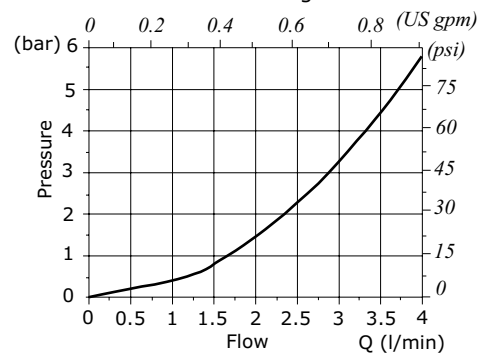

Pressure reducing vs. control current

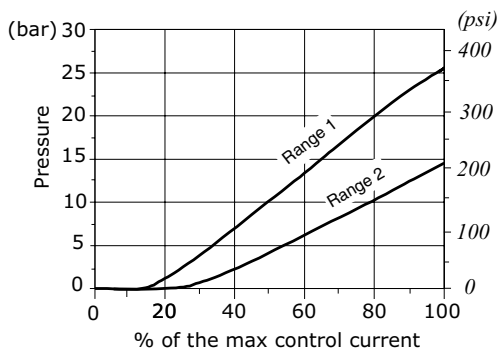

Reducing/relieving pressure vs. flow
for % of control current - Pressure range **1**

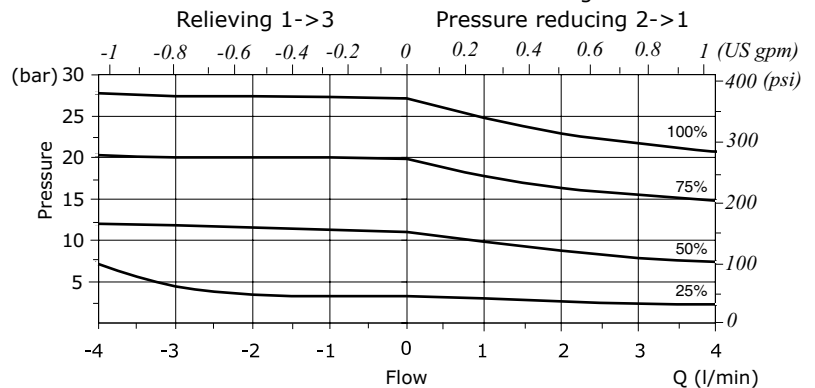



RD08S-RD08T type pressure reducing valves - 3 way

- Solenoid proportional type, direct acting
- With relieving (NO)
- Spool type

Technical specifications and diagrams are measured with mineral oil of 46 cSt viscosity at 40°C (104°F) temperature.

	RD08S	RD08T
Nominal flow	4 l/min (1.05 US gpm)	12 l/min (3.17 US gpm)
Max. pressure	210 bar (3050 psi)	
Oil leakage	-	-
Fluid	mineral based oil	
Viscosity	10-200 cSt	
Max level of contamination	18/16/13 ISO4406	
Fluid temperature	with NBR seals with FPM seals	from -20°C (-4°F) to 80°C (176°F) from -20°C (-4°F) to 100°C (212°F)
Environmental temp. for working conditions	from -40°C (-40°F) to 100°C (212°F)	
Cavity	SAE 08/3	SAE 8/3
Coil type*	MSM 19	
Nominal voltages	12 VDC - 24 VDC	
Power rating	21.6 W (12 VDC) - 22.5 W (24 VDC)	
Max control current	12 V -> 1.25 A - 24 V -> 0.68A	
Dither frequency	150 Hz	
Hysteresis	≤4%	
Weight	0.492 kg (1.08 lb)	1.140 kg (0.79 lb)

NOTE - For different conditions, please contact Walvoil Sales Dpt. - For coils further features see from page 206.

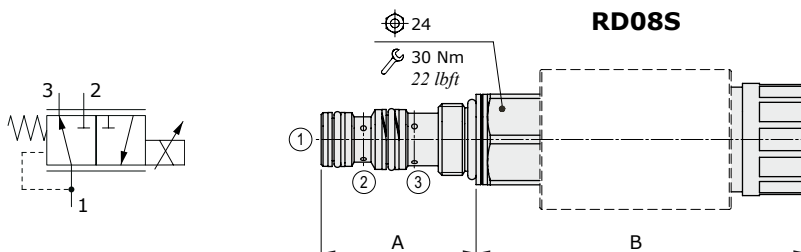

Valve type	A		B	
	mm	in	mm	in
RD08S	41	1.61	87.5	1.27
RD08T	41	1.61	97	1.81

Ordering codes and description composition

RD08S/003B



RD08S/023B

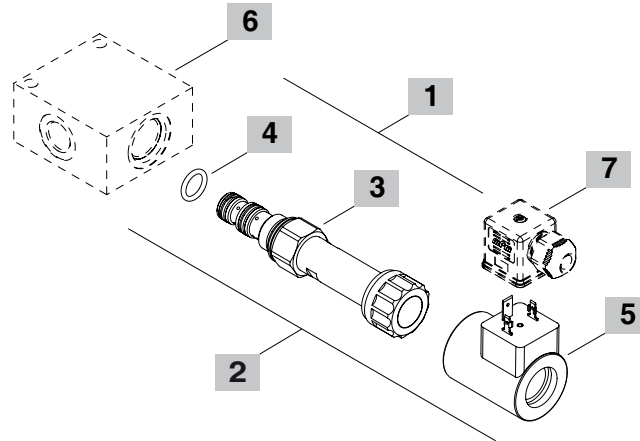

1 Cartridges

TYPE	CODE	DESCRIPTION
RD08S/003B	0RD08002025	Pressure range 3
RD08T/001B	0RD08002016	Pressure range 1

2 Complete cartridges

TYPE	CODE	DESCRIPTION
RD08S/023B	0RD08002023	Pressure range 3 , 12VDC
RD08T/021B	0RD08002024	Pressure range 1 , 12VDC

3 Pressure range

TYPE	DESCRIPTION
1	Pressure range 5÷45 bar (72.5÷652.5 psi) for cartridge RD08T type
3	Pressure range 5÷35 bar (72.5÷507.5 psi) for cartridge RD08S type

4 Seals

TYPE	DESCRIPTION
B	NBR (Buna) o-ring seals, std configuration
V	FPM (Viton) o-ring seals, contact Sales Dept.

5 Coils

TYPE	CODE	DESCRIPTION
2) MSM 19 12VDC	4SL5000128	12VDC-ISO4400 coil
4) MSM 19 24VDC	4SL5000247	24VDC-ISO4400 coil

For complete coils list see page 206

6 Valve body

TYPE	CODE	DESCRIPTION
SAE 08/3-SAE8	3CC0830K11	Aluminium body for cavity 08 valve, SAE8 std thread

Note: aluminium body can stand up to 210 bar (3050 psi)
For steel bodies or different threading see from page 217

7 Connector

TYPE	CODE	DESCRIPTION
ISO4400	4CN1009995	Connector

For complete connectors list see from page 206

RD08S pressure reducing vs. control current
 12 VDC power supply

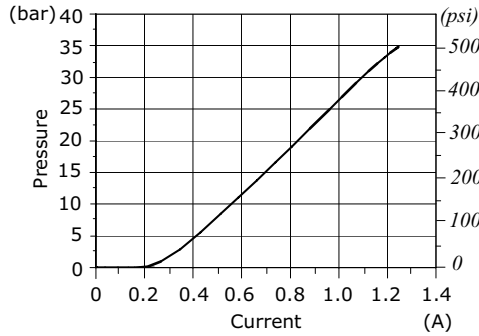

RD08S pressure drop vs. flow 2->1

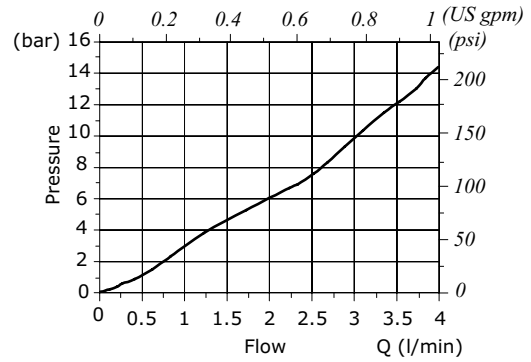

RD08S reducing/relieving pressure vs. flow
 for % of control current

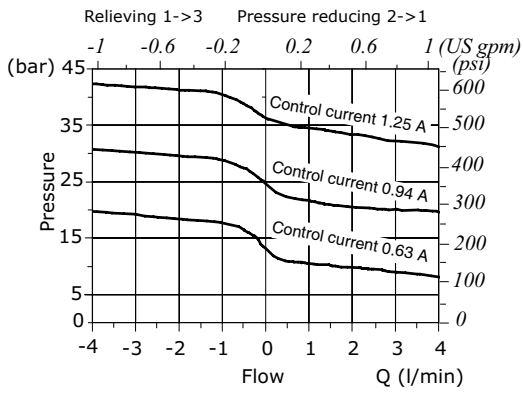

RD08T pressure reducing vs. control current
 12 VDC power supply

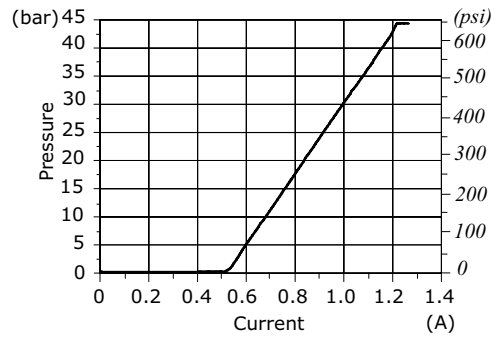

RD08T pressure drop vs. flow 2->1

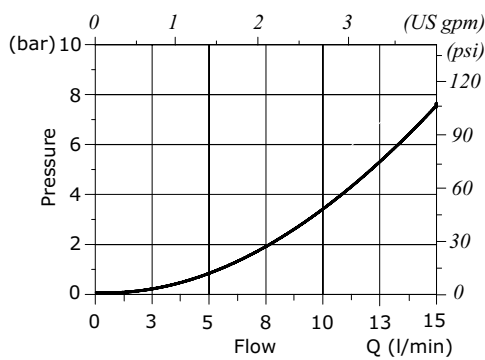

RD08T reducing/relieving pressure vs. flow
 for % of control current

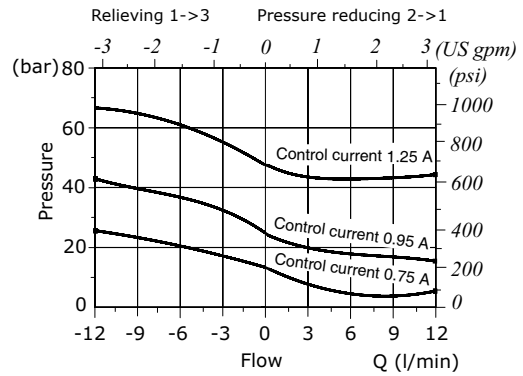





RM..A type pressure reducing valves - 3 way

- Pilot operated
- Without relieving
- Spool type
- From SAE10 to SAE16 cavities

Technical specifications and diagrams are measured with mineral oil of 46 cSt viscosity at 40°C (104°F) temperature.

	RM10A	RM12A	RM16A
Nominal flow	50 l/min (13 US gpm)	100 l/min (26 US gpm)	150 l/min (40 US gpm)
Max. pressure	350 bar (5100 psi)		
Oil leakage	-		
Fluid	mineral based oil		
Viscosity	10-200 cSt		
Max level of contamination	20/18/14 ISO4406		
Fluid temperature	with NBR seals with FPM seals	from -20°C (-4°F) to 80°C (176°F) from -20°C (-4°F) to 100°C (212°F)	
Environmental temp. for working conditions	from -20°C (-4°F) to 50°C (122°F)		
Cavity	SAE 10/3	SAE 12/3	SAE 16/3
Weight	0.210 kg (0.46 lb)	0.340 kg (0.75 lb)	0.470 kg (1.04 lb)

NOTE - For different conditions, please contact Walvoil Sales Dpt.

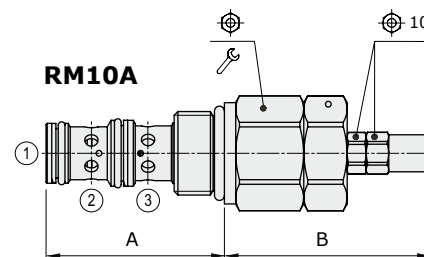
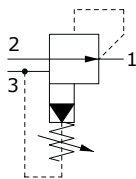

Valve type	A		B		⌀	⌘
	mm	in	mm	in		
RM10A/1S	47.2	1.86	54.5	2.15	27	50 37
RM12A/0S	73.5	2.89	51.5	2.03	32	70 52
RM16A/0S	75	2.95	50.5	1.99	41	100 74

For dimensions with different type of adjustment see page 212

Ordering codes and description composition

RM10A/1S1B

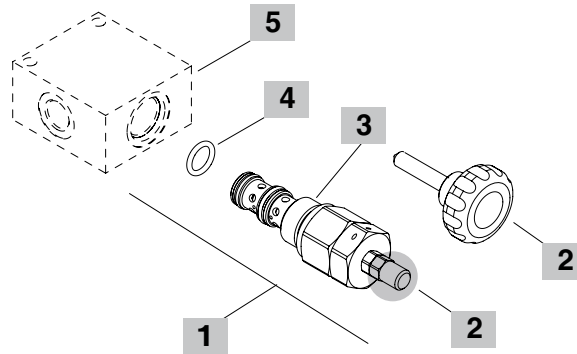
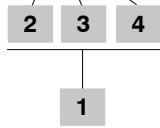

1 Cartridges

TYPE	CODE	DESCRIPTION
SAE cavity 10/3		
RM10A/1S1B	ORM10002012	Pressure range 1
RM10A/1S2B	ORM10002013	Pressure range 2
RM10A/1S3B	ORM10002014	Pressure range 3
SAE cavity 12/3		
RM12A/0S1B	ORM12002008	Pressure range 1
RM12A/0S2B	ORM12002000	Pressure range 2
RM12A/0S3B	ORM12002016	Pressure range 3
SAE cavity 16/3		
RM16A/0S1B	ORM16002008	Pressure range 1
RM16A/0S2B	ORM16002000	Pressure range 2
RM16A/0S3B	ORM16002009	Pressure range 3

3 Adjustments

TYPE	DESCRIPTION
S	Screw with cap
V	With handwheel

3 Pressure range

Standard setting is referred to at 5 l/min (1.32 US gpm) flow

TYPE	DESCRIPTION
1	Pressure range 5÷80 bar (72.5÷1160 psi); Std. setting 50 bar (725 psi)
2	Pressure range 50÷220 bar (725÷3190 psi); Std. setting 150 bar (2175 psi)
3	For SAE cavity 10/3: pressure range 100÷350 bar (1450÷5075 psi); Std. setting 250 bar (3625 psi) For SAE cavity 12/3 and 16/3: pressure range 180÷350 bar (2610÷5075 psi); Std. setting 250 bar (3625 psi)

4 Seals

TYPE	DESCRIPTION
B	NBR (Buna) o-ring seals, std configuration
V	FPM (Viton) o-ring seals, contact Sales Dept.

5 Valve body

TYPE	CODE	DESCRIPTION
SAE 10/3-SAE8	3CC1030K11	Aluminium body for cavity 10 valve, SAE8 std thread
SAE 12/3-SAE10	3CC1230L11	Aluminium body for cavity 12 valve, SAE10 std thread
SAE 16/3-SAE12	3CC1630M11	Aluminium body for cavity 16 valve, SAE12 std thread

Note: aluminium body can stand up to 210 bar (3050 psi)
For steel bodies or different threading see from page 217

Rating diagrams

RM10A pressure drop vs. flow 2->1

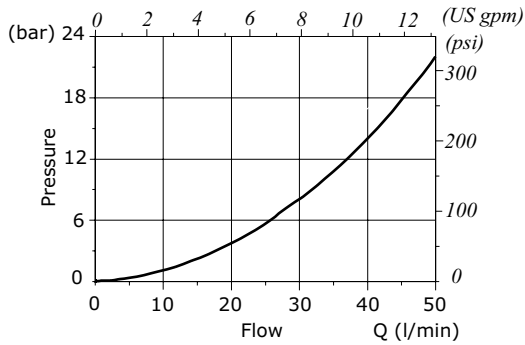

RM10A pressure reducing vs. flow 2->1

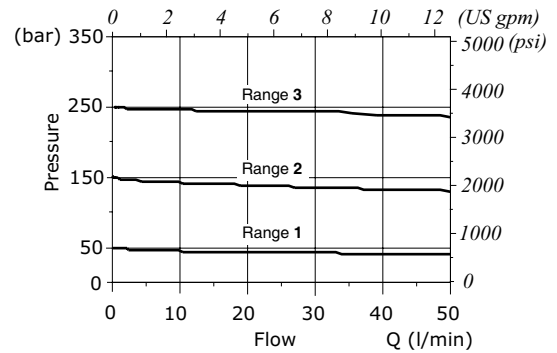

RM12A pressure reducing vs. flow 2->1

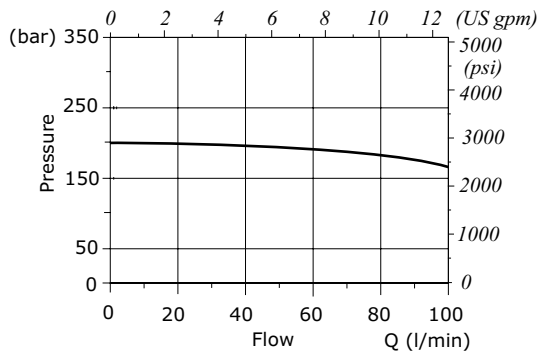

RM16A pressure drop vs. flow 2->1

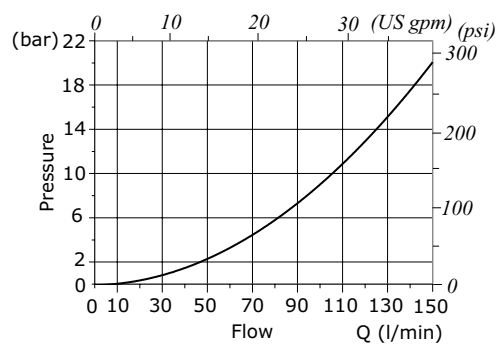

RM16A pressure reducing vs. flow 2->1

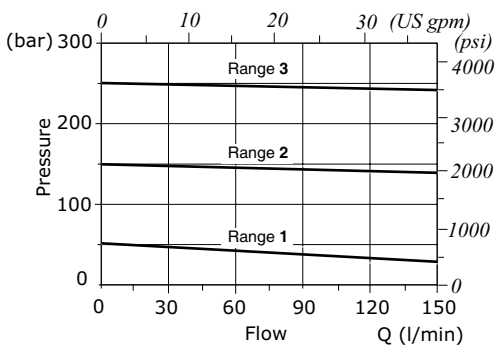





RM..W type pressure reducing valves - 3 way

- Solenoid proportional type, pilot operated
- Without relieving
- Spool type
- From SAE10 to SAE16 cavities

Technical specifications and diagrams are measured with mineral oil of 46 cSt viscosity at 40°C (104°F) temperature.

	RM10W	RM12W	RM16W
Nominal flow	50 l/min (13 US gpm)	100 l/min (26 US gpm)	150 l/min (40 US gpm)
Max. pressure	350 bar (5100 psi)		
Oil leakage	-		
Fluid	mineral based oil		
Viscosity	10-200 cSt		
Max level of contamination	18/16/13 ISO4406		
Fluid temperature	with NBR seals with FPM seals	from -20°C (-4°F) to 80°C (176°F) from -20°C (-4°F) to 100°C (212°F)	
Environmental temp. for working conditions	from -20°C (-4°F) to 50°C (122°F)		
Cavity	SAE 10/3	SAE 12/3	SAE 16/3
Coil type*	MP35		
Nominal voltages	12 VDC - 24 VDC		
Power rating	11.2 W (12 VDC) - 11.4 W (24 VDC)		
Max control current	12 V -> 1.25 A - 24 V -> 0.68 A		
Dither frequency	150 Hz		
Hysteresis	≤4%		
Weight	0.680 kg (1.50 lb)	0.820 kg (1.81 lb)	0.930 kg (2.05 lb)

NOTE - For different conditions, please contact Walvoil Sales Dpt. - For coils further features see from page 206.

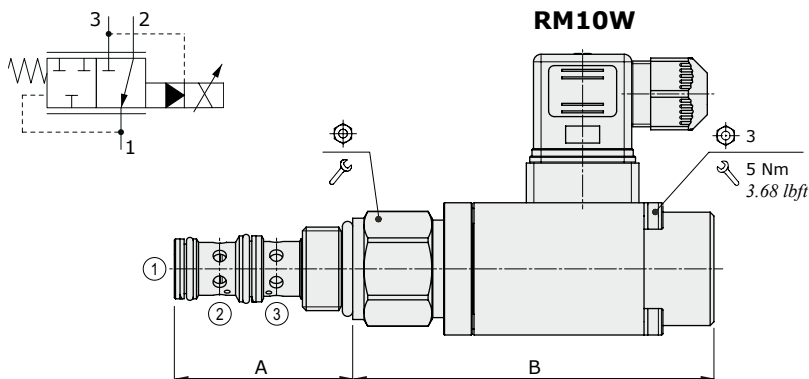

Valve type	A		B		⌀	⌘	Nm	lbft
	mm	in	mm	in				
RM10W	47.2	1.86	95.6	3.76	27	50	37	
RM12W	73.5	2.89	93.5	3.68	32	70	52	
RM16W	75	2.95	92	3.62	41	100	74	

Ordering codes and description composition

RM10W/121B

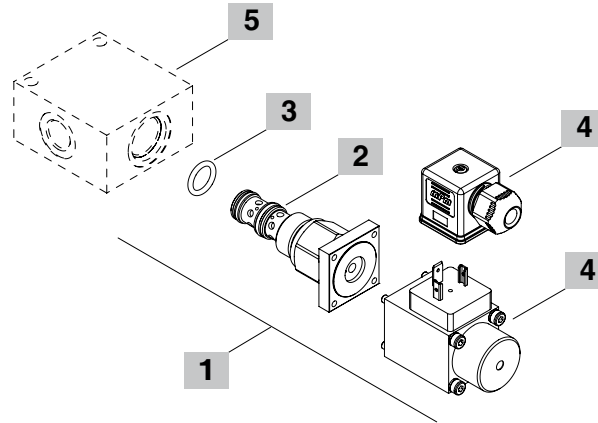
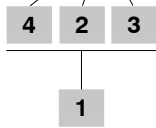

1 Cartridges

TYPE	CODE	DESCRIPTION
SAE cavity 10/3		
RM10W/121B	ORM10002015	Pressure range 1 , 12VDC
RM10W/122B	ORM10002016	Pressure range 2 , 12VDC
RM10W/123B	ORM10002017	Pressure range 3 , 12VDC
RM10W/124B	ORM10002018	Pressure range 4 , 12VDC
SAE cavity 12/3		
RM12W/021B	ORM12002003	Pressure range 1 , 12VDC
RM12W/022B	ORM12002005	Pressure range 2 , 12VDC
RM12W/024B	ORM12002001	Pressure range 4 , 12VDC
SAE cavity 16/3		
RM16W/021B	ORM16002004	Pressure range 1 , 12VDC
RM16W/022B	ORM16002005	Pressure range 2 , 12VDC
RM16W/023B	ORM16002006	Pressure range 3 , 12VDC
RM16W/024B	ORM16002001	Pressure range 4 , 12VDC

2 Pressure range

TYPE	DESCRIPTION
1	Pressure range 5÷50 bar (72.5÷725 psi)
2	Pressure range 50÷200 bar (725÷2900 psi)
3	Pressure range 80÷350 bar (1160÷5100 psi)
4	Pressure range 20÷100 bar (290÷1450 psi) Pressure range 10÷80 bar (145÷1160 psi) only for RM12W/024B

3 Seals

TYPE	DESCRIPTION
B	NBR (Buna) o-ring seals, std configuration
V	FPM (Viton) o-ring seals, contact Sales Dept.

4 Coils and connectors

TYPE	CODE	DESCRIPTION
2) MP35 12VDC	5SL4000120	12VDC-ISO4400 coil
ISO4400	4CN1009995	Connector
4) MP35 24VDC	4SL4000240	24VDC-ISO4400 coil
ISO4400	4CN1009995	Connector

For complete coils and connectors list see from page 206

5 Valve body

TYPE	CODE	DESCRIPTION
SAE 10/3-SAE8	3CC1030K11	Aluminium body for cavity 10 valve, SAE8 std thread
SAE 12/3-SAE10	3CC1230L11	Aluminium body for cavity 12 valve, SAE10 std thread
SAE 16/3-SAE12	3CC1630M11	Aluminium body for cavity 16 valve, SAE12 std thread

Note: aluminium body can stand up to 210 bar (3050 psi)
For steel bodies or different threading see from page 217

Rating diagrams

RM10W pressure drop vs. flow 2->1

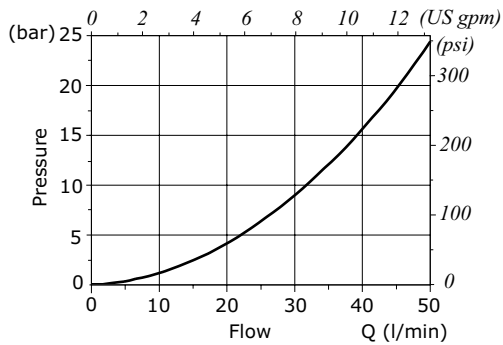

RM10W pressure reducing vs. control current

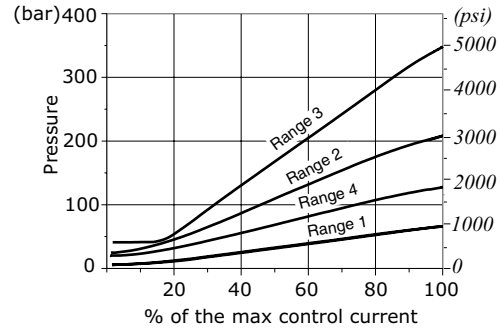

RM10W pressure reducing vs. flow for % of control current - Pressure range 2 -

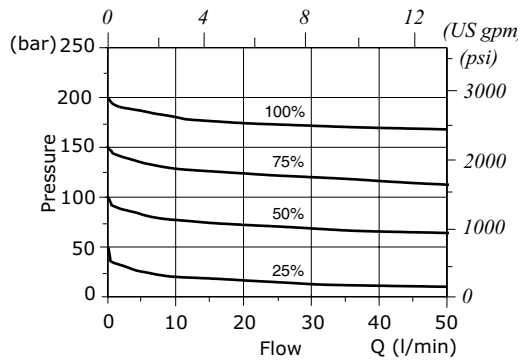

RM12W pressure drop vs. flow 2->1

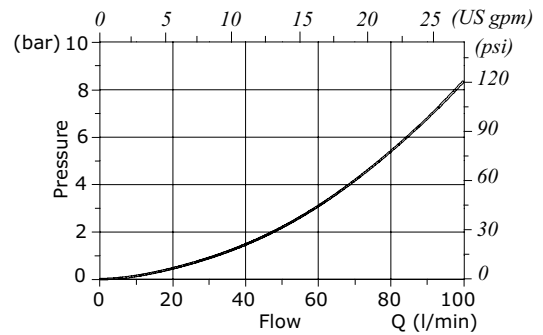

RM12W pressure reducing vs. control current

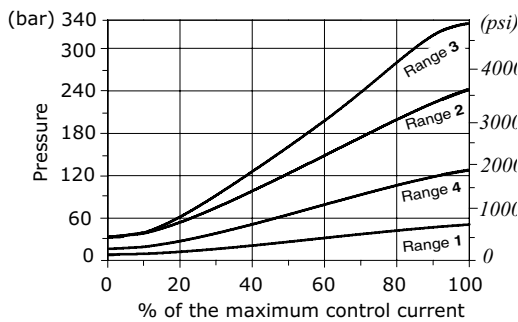

RM12W pressure reducing vs. flow for % of control current - Pressure range 2 -

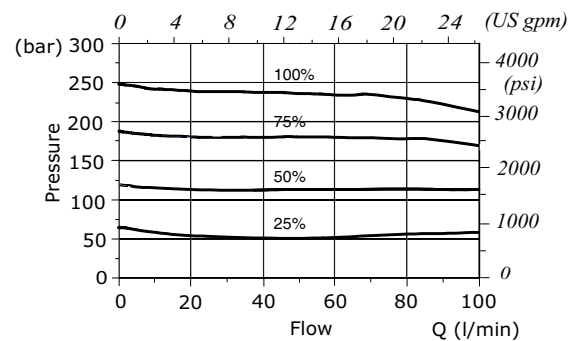

Rating diagrams

RM16W pressure vs. flow 2->1

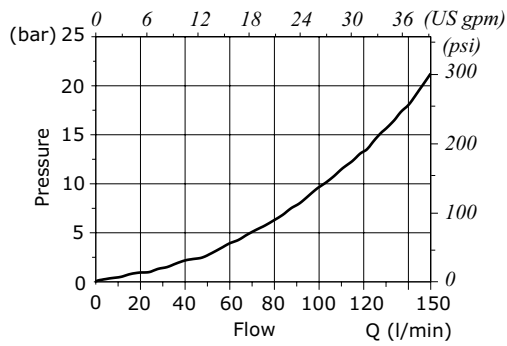

RM16W pressure setting vs. % max. control current

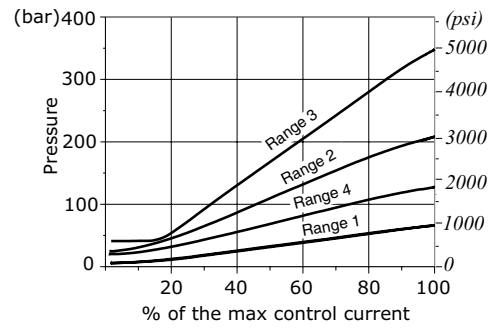

RM16W pressure reducing vs. flow
for % of control current - Pressure range 2 -

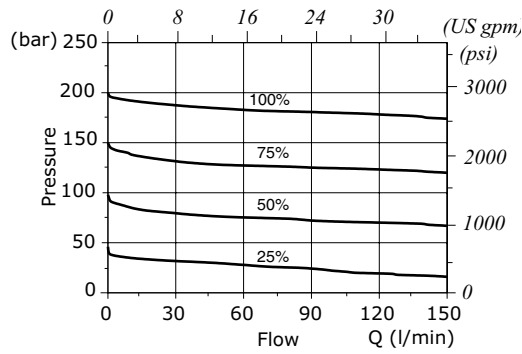



RP..A type pressure reducing valves - 3 way

- Pilot operated
- With relieving
- Spool type
- From SAE10 to SAE16 cavities

Technical specifications and diagrams are measured with mineral oil of 46 cSt viscosity at 40°C (104°F) temperature.

	RP10A	RP12A	RP16A
Nominal flow	50 l/min (7.9 US gpm)	100 l/min (26 US gpm)	150 l/min (40 US gpm)
Max. pressure		350 bar (5100 psi)	
Oil leakage		-	
Fluid		mineral based oil	
Viscosity		10-200 cSt	
Max level of contamination		20/18/14 ISO4406	
Fluid temperature	with NBR seals with FPM seals	from -20°C (-4°F) to 80°C (176°F) from -20°C (-4°F) to 100°C (212°F)	
Environmental temp. for working conditions		from -20°C (-4°F) to 50°C (122°F)	
Cavity	SAE 10/3	SAE 12/3	SAE 16/3
Weight	0.210 kg (0.46 lb)	0.330 kg (0.72 lb)	0.420 kg (0.92 lb)

NOTE - For different conditions, please contact Walvoil Sales Dpt.

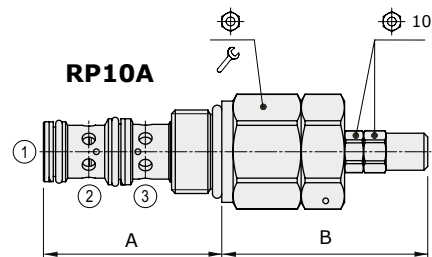
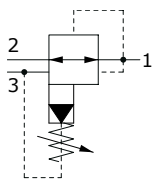

Valve type	A		B		⌀	Nm	lbft
	mm	in	mm	in			
RP10A/1S	47.2	1.86	54.5	2.15	27	50	37
RP12A/0S	73.5	2.89	51.5	2.03	32	80	59
RP16A/0S	75	2.95	50.5	1.99	41	100	74

For dimensions with different type of adjustment see page 212

Ordering codes and description composition

RP10A/1S1B

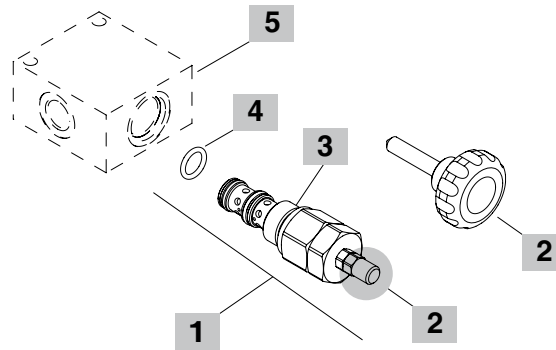
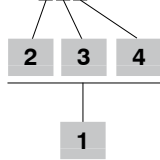

1 Cartridges

TYPE	CODE	DESCRIPTION
SAE cavity 10/3		
RP10A/1S1B	ORP10002016	Pressure range 1
RP10A/1S2B	ORP10002017	Pressure range 2
RP10A/1S3B	ORP10002018	Pressure range 3
SAE cavity 12/3		
RP12A/0S1B	ORP12002002	Pressure range 1
RP12A/0S2B	ORP12002003	Pressure range 2
RP12A/0S3B	ORP12002000	Pressure range 3
SAE cavity 16/3		
RP16A/0S1B	ORP16002006	Pressure range 1
RP16A/0S2B	ORP16002000	Pressure range 2
RP16A/0S3B	ORP16002011	Pressure range 3

2 Adjustments

TYPE	DESCRIPTION
S	Screw with cap
V	With handwheel

3 Pressure range

Standard setting is referred to at 5 l/min (1.32 US gpm) flow

TYPE	DESCRIPTION
1	Pressure range 5÷80 bar (72.5÷1160 psi); Std. setting 50 bar (725 psi) at 5 l/min (1.32 US gpm)
2	Pressure range 50÷220 bar (725÷3190 psi); Std. setting 150 bar (2175 psi) at 5 l/min (1.32 US gpm)
3	For SAE cavity 10/3: pressure range 100÷350 bar (1450÷5075 psi); Std. setting 250 bar (3625 psi) For SAE cavity 12/3 and 16/3: pressure range 180÷350 bar (2610÷5075 psi); Std. setting 250 bar (3625 psi)

4 Seals

TYPE	DESCRIPTION
B	NBR (Buna) o-ring seals, std configuration
V	FPM (Viton) o-ring seals, contact Sales Dept.

5 Valve body

TYPE	CODE	DESCRIPTION
SAE 10/3-SAE8	3CC1030K11	Aluminium body for cavity 10 valve, SAE8 std thread
SAE 12/3-SAE10	3CC1230L11	Aluminium body for cavity 12 valve, SAE10 std thread
SAE 16/3-SAE12	3CC1630M11	Aluminium body for cavity 16 valve, SAE12 std thread

Note: aluminium body can stand up to 210 bar (3050 psi)
For steel bodies or different threading see from page 217

Rating diagrams

RP10A pressure drop vs. flow

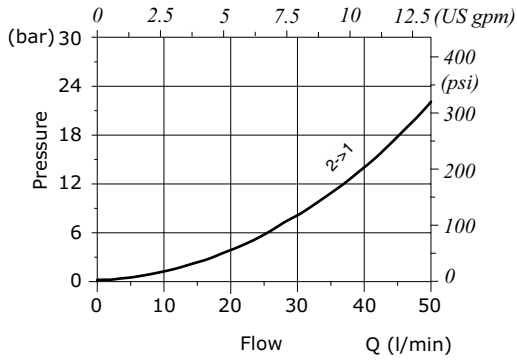

RP10A reducing/relieving pressure vs. flow

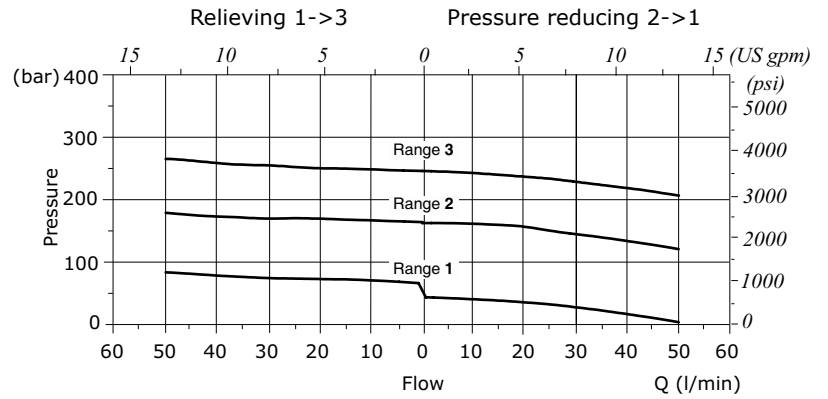

RP12A pressure drop vs. flow

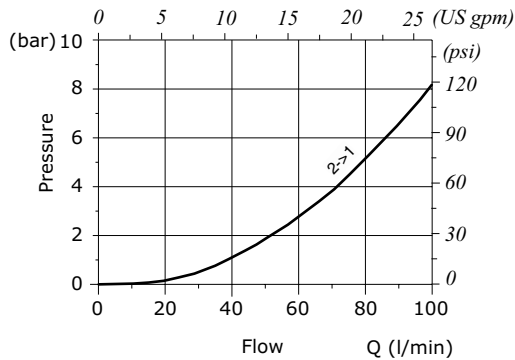

RP12A reducing/relieving pressure vs. flow

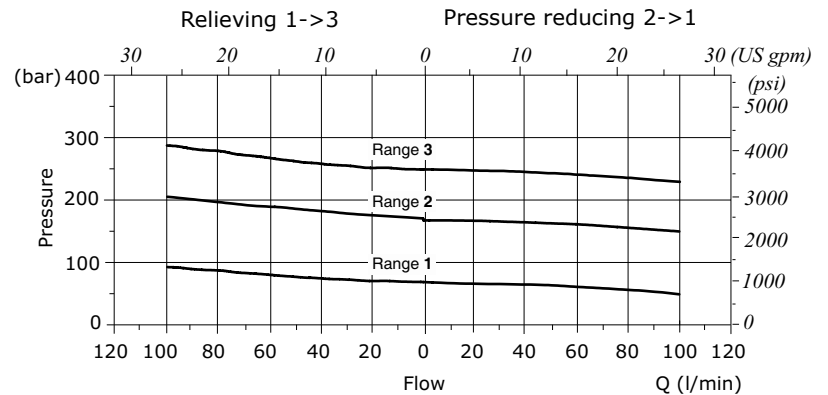

RP16A pressure drop vs. flow

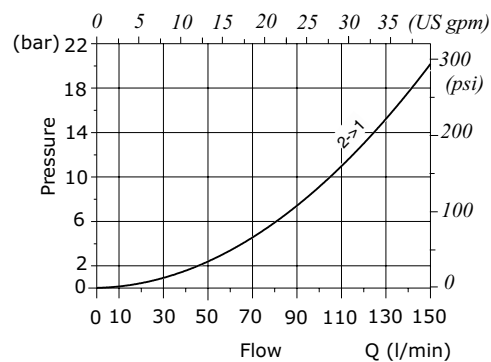

RP16A reducing/relieving pressure vs. flow

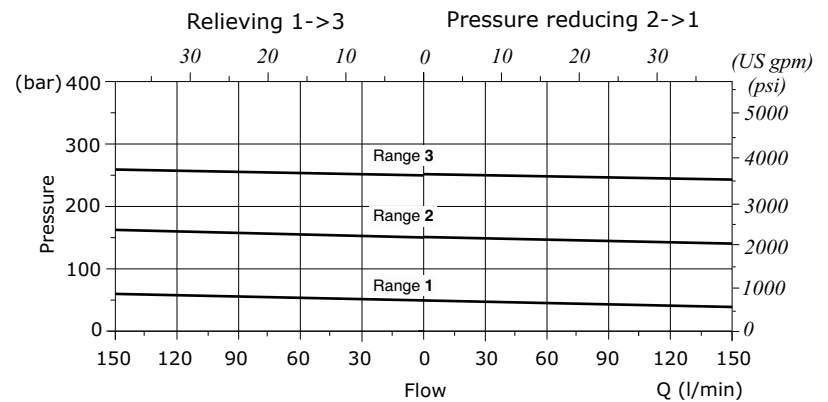





RP..W type pressure reducing valves - 3 way

- Solenoid proportional type, pilot operated
- With relieving
- Spool type
- From SAE10 to SAE16 cavities

Technical specifications and diagrams are measured with mineral oil of 46 cSt viscosity at 40°C (104°F) temperature.

	RP10W	RP12W	RP16W
Nominal flow	50 l/min (13 US gpm)	100 l/min (26 US gpm)	150 l/min (40 US gpm)
Max. pressure	350 bar (5100 psi) - in 3=210 bar (3045 psi)		
Oil leakage	-		
Fluid	mineral based oil		
Viscosity	10-200 cSt		
Max level of contamination	18/16/13 ISO4406		
Fluid temperature	with NBR seals with FPM seals	from -20°C (-4°F) to 80°C (176°F) from -20°C (-4°F) to 100°C (212°F)	
Environmental temp. for working conditions	from -20°C (-4°F) to 50°C (122°F)		
Cavity	SAE 10/3	SAE 12/3	SAE 16/3
Coil type*	MP35		
Nominal voltages	12 VDC - 24 VDC		
Power rating	11.2 W (12 VDC) - 11.4 W (24 VDC)		
Max control current	12 V -> 1.25 A - 24 V -> 0.68 A		
Dither frequency	150 Hz		
Hysteresis	≤4%		
Weight	0.680 kg (1.50 lb)	0.820 kg (1.81 lb)	0.930 kg (2.05 lb)

NOTE - For different conditions, please contact Walvoil Sales Dpt. - For coils further features see from page 206.

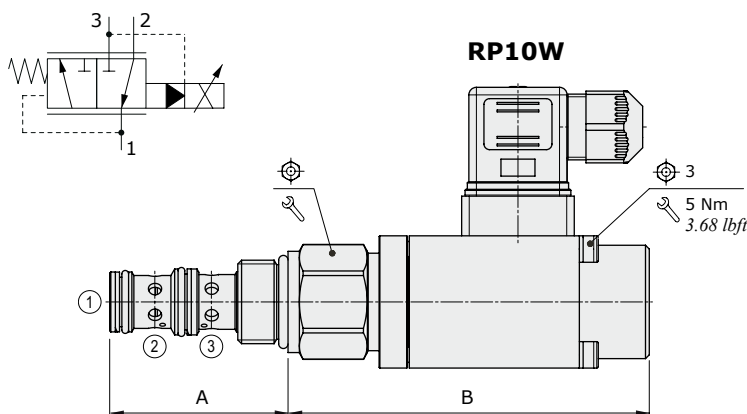

Valve type	A		B		⌀	⌘	Nm	lbft
	mm	in	mm	in				
RP10W	47.2	1.86	95.6	3.76	27	50	37	
RP12W	73.5	2.89	93.5	3.68	32	70	52	
RP16W	75	2.95	92	3.62	41	100	74	

Ordering codes and description composition

RP10W/121B

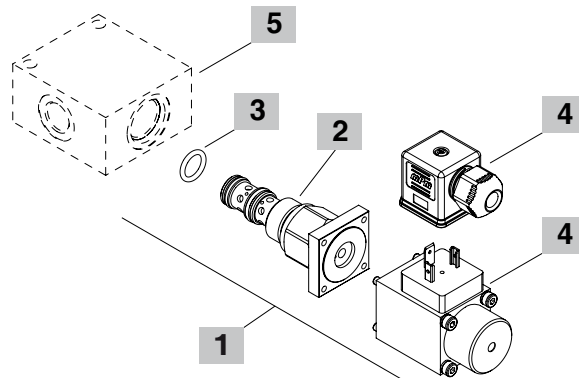
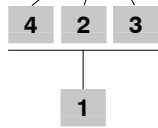

1 Cartridges

TYPE	CODE	DESCRIPTION
SAE cavity 10/3		
RP10W/121B	ORP10002020	Pressure range 1 , 12VDC
RP10W/122B	ORP10002021	Pressure range 2 , 12VDC
RP10W/123B	ORP10002022	Pressure range 3 , 12VDC
RP10W/124B	ORP10002023	Pressure range 4 , 12VDC
SAE cavity 12/3		
RP12W/021B	ORP12002007	Pressure range 1 , 12VDC
RP12W/022B	ORP12002009	Pressure range 2 , 12VDC
RP12W/024B	ORP12002005	Pressure range 3 , 12VDC
SAE cavity 16/3		
RP16W/021B	ORP16002004	Pressure range 1 , 12VDC
RP16W/022B	ORP16002008	Pressure range 2 , 12VDC
RP16W/023B	ORP16002009	Pressure range 3 , 12VDC
RP16W/024B	ORP16002001	Pressure range 4 , 12VDC

2 Pressure range

TYPE	DESCRIPTION
1	Pressure range 5÷50 bar (72.5÷725 psi)
2	Pressure range 50÷200 bar (725÷2900 psi)
3	Pressure range 80÷350 bar (1160÷5075 psi)
4	Pressure range 20÷100 bar (290÷1450 psi) Pressure range 10÷80 bar (145÷1160 psi) only for RP12W/024B

3 Seals

TYPE	DESCRIPTION
B	NBR (Buna) o-ring seals, std configuration
V	FPM (Viton) o-ring seals, contact Sales Dept.

4 Coils and connectors

TYPE	CODE	DESCRIPTION
2) MP35 12VDC	5SL4000120	12VDC-ISO4400 coil
ISO4400	4CN1009995	Connector
4) MP35 24VDC	4SL4000240	24VDC-ISO4400 coil
ISO4400	4CN1009995	Connector

For complete coils and connectors list see from page 206

5 Valve body

TYPE	CODE	DESCRIPTION
SAE 10/3-SAE8	3CC1030K11	Aluminium body for cavity 10 valve, SAE8 std thread
SAE 12/3-SAE10	3CC1230L11	Aluminium body for cavity 12 valve, SAE10 std thread
SAE 16/3-SAE12	3CC1630M11	Aluminium body for cavity 16 valve, SAE12 std thread

Note: aluminium body can stand up to 210 bar (3050 psi)
For steel bodies or different threading see from page 217

Rating diagrams

RP10W pressure drop vs. flow 2->1

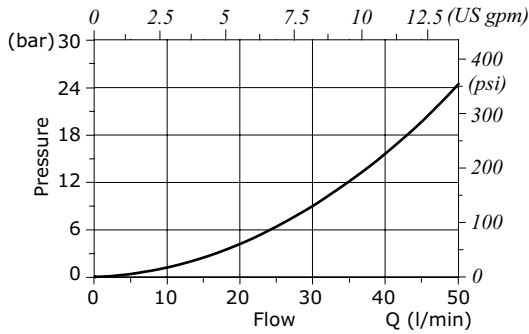

RP10W pressure drop vs. flow 1->3 with de-energized coil

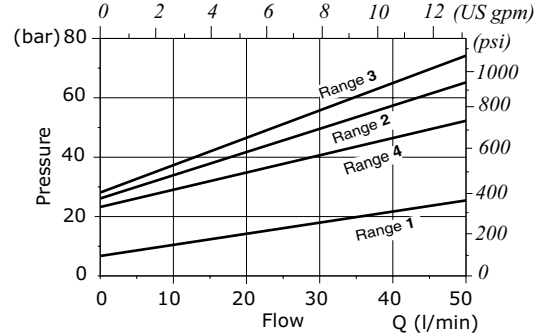

RP10W pressure reducing vs. control current

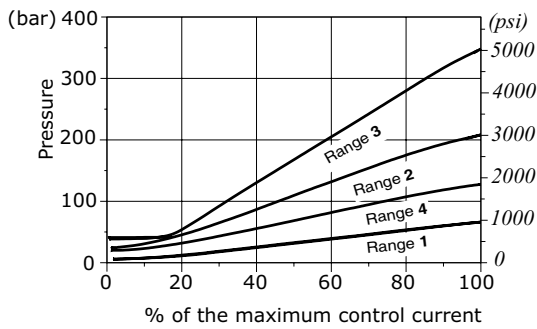

RP10W reducing/relieving pressure vs. flow for % of control current - Pressure range 2

Relieving 1->3 Pressure reducing 2->1

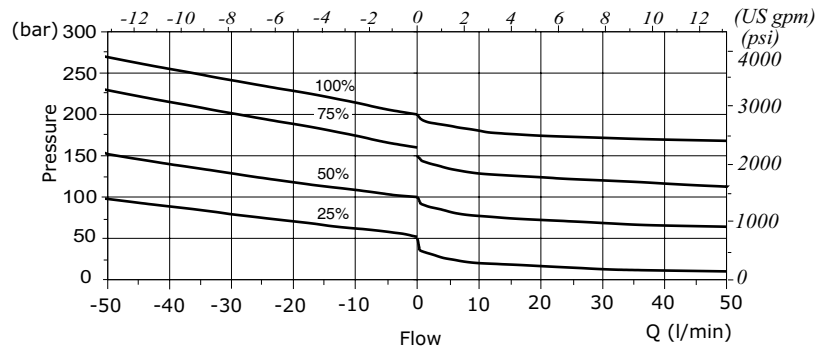

RP12W pressure drop vs. flow 2->1

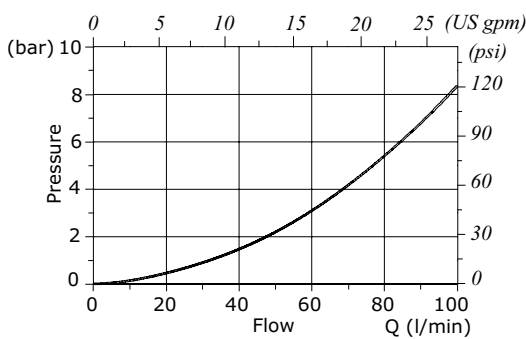

RP12W pressure drop vs. flow 1->3 with de-energized coil

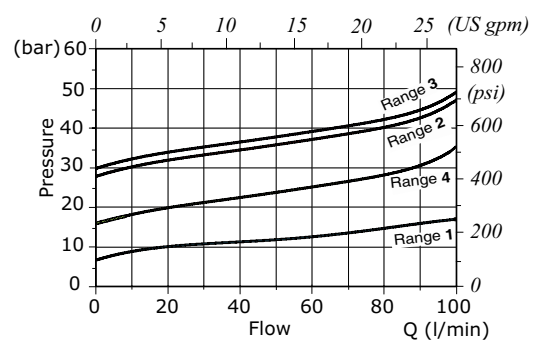

Rating diagrams

RP12W pressure reducing vs. control current

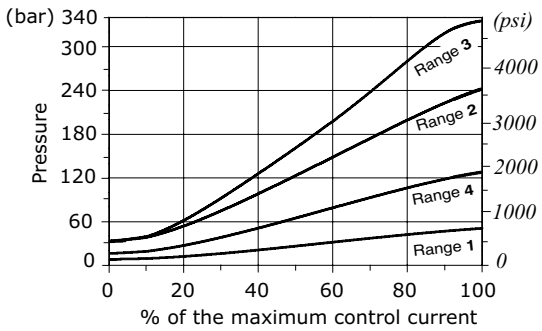

RP12W reducing/relieving pressure vs. flow

for % of control current - Pressure range 2 -

Relieving 1->3

Pressure reducing 2->1

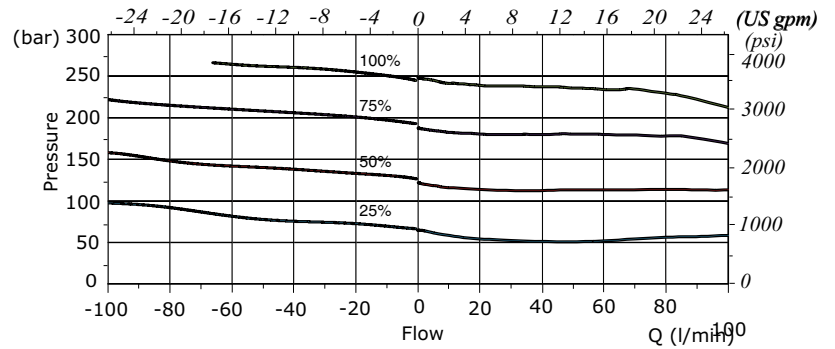

RP16W pressure drop vs. flow 2->1

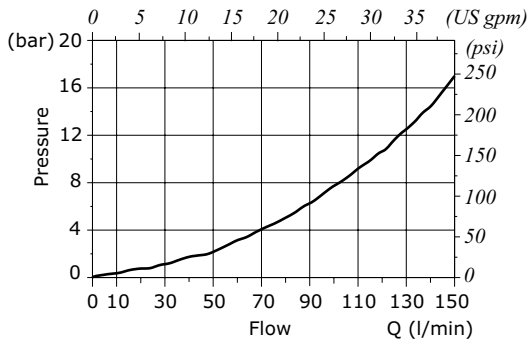

RP16W pressure drop vs. flow 1->3

with de-energized coil

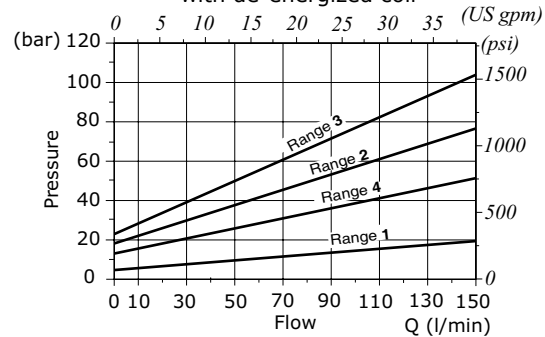

RP16W pressure reducing vs. control current

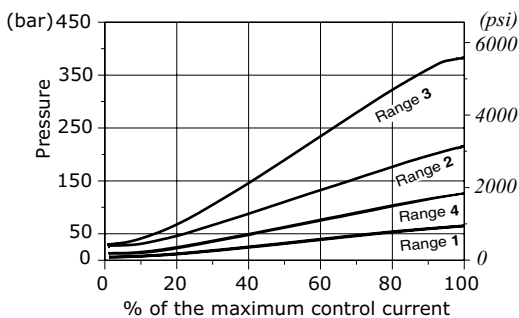

RP16W reducing/relieving pressure vs. flow

for % of control current - Pressure range 2 -

Relieving 1->3

Pressure reducing 2->1

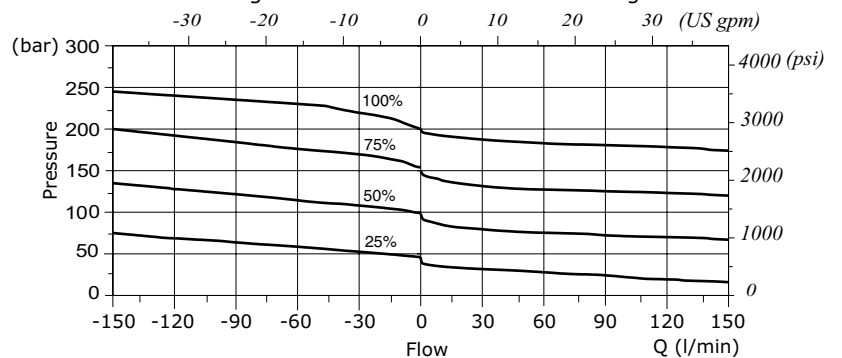



RP08X type pressure reducing valves - 3 way

- Solenoid proportional type, pilot operated
- With relieving (NO)
- Spool type

Technical specifications and diagrams are measured with mineral oil of 46 cSt viscosity at 40°C (104°F) temperature.

RP08X		
Nominal flow		15 l/min (4 US gpm)
Max. pressure		350 bar (5100 psi)
Oil leakage		-
Fluid		mineral based oil
Viscosity		10-200 cSt
Max level of contamination		18/16/13 ISO4406
Fluid temperature	with NBR seals	from -20°C (-4°F) to 80°C (176°F)
	with FPM seals	from -20°C (-4°F) to 100°C (212°F)
Environmental temp. for working conditions		from -20°C (-4°F) to 50°C (122°F)
Cavity		SAE 08/3
Coil type*		BDP19
Nominal voltages		12 VDC - 24 VDC
Power rating		13 W (12 VDC) - 13.25 W (24 VDC)
Max control current		12 V -> 1.9 A - 24 V -> 0.9 A
Dither frequency		150 Hz
Hysteresis		≤4%
Weight		0.56 kg (1.23 lb)

NOTE - For different conditions, please contact Walvoil Sales Dpt. - For coils further features see from page 206.

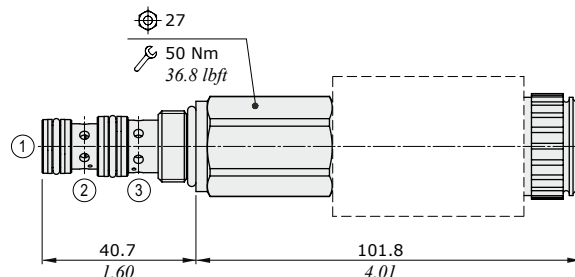
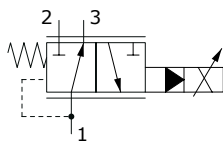

Ordering codes and description composition

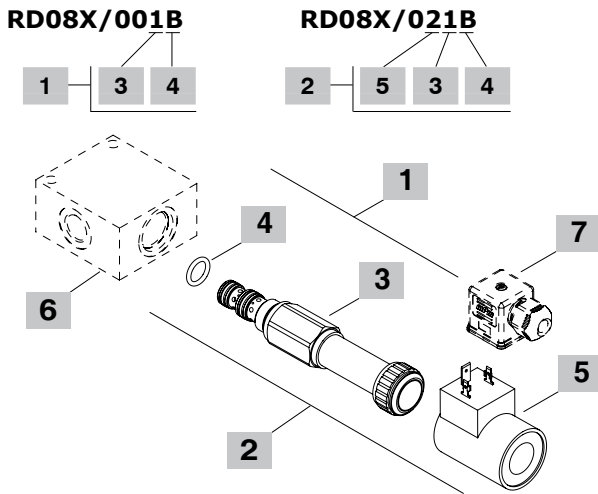

1 Cartridges

TYPE	CODE	DESCRIPTION
RP08X/001B	ORP08002010	Pressure range 1
RP08X/002B	ORP08002011	Pressure range 2
RP08X/003B	ORP08002012	Pressure range 3
RP08X/004B	ORP08002013	Pressure range 4

2 Complete cartridges

TYPE	CODE	DESCRIPTION
RP08X/021B	ORP08002007	Pressure range 1 , 12VDC
RP08X/022B	ORP08002001	Pressure range 2 , 12VDC
RP08X/023B	ORP08002002	Pressure range 3 , 12VDC
RP08X/024B	ORP08002003	Pressure range 4 , 12VDC

3 Pressure range

TYPE	DESCRIPTION
1	Pressure range 10÷50 bar (145÷725 psi)
2	Pressure range 50÷200 bar (725÷2900 psi)
3	Pressure range 80÷350 bar (1160÷5075 psi)
4	Pressure range 20÷100 bar (290÷1450 psi)

4 Seals

TYPE	DESCRIPTION
B	NBR (Buna) o-ring seals, std configuration
V	FPM (Viton) o-ring seals, contact Sales Dept.

5 Coils

TYPE	CODE	DESCRIPTION
2) BDP19 12VDC	4SL5000120	12VDC-ISO4400 coil
4) BDP19 24VDC	4SL5000240	24VDC-ISO4400 coil

For complete coils list see page 206

6 Valve body

TYPE	CODE	DESCRIPTION
SAE 08/3-SAE8	3CC0830K11	Aluminium body for cavity 10 valve, SAE8 std thread

Note: aluminium body can stand up to 210 bar (3050 psi)
For steel bodies or different threading see from page 217

7 Connector

TYPE	CODE	DESCRIPTION
ISO4400	4CN1009995	Connector

For complete connectors list see from page 206

Rating diagram

Pressure drop vs. flow 2->1
with de-energized coil

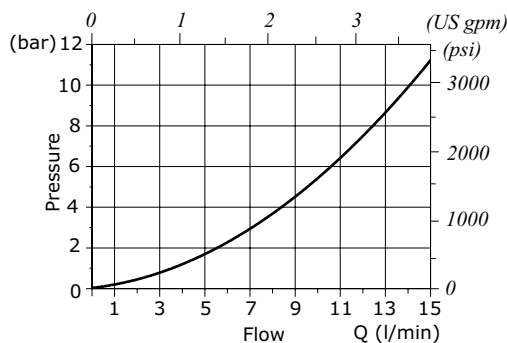

Pressure drop vs. flow 1->3

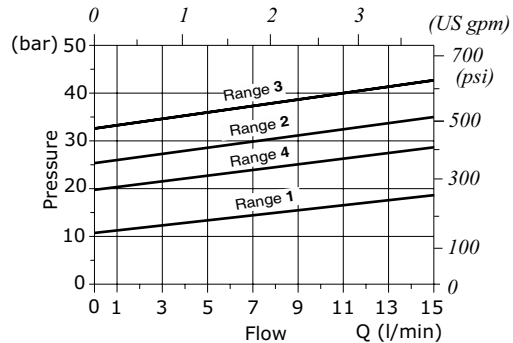

Pressure reducing vs. control current

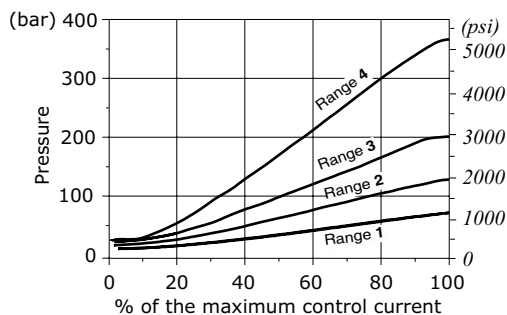

Reducing/relieving pressure vs. flow
for % of control current - Pressure range 2

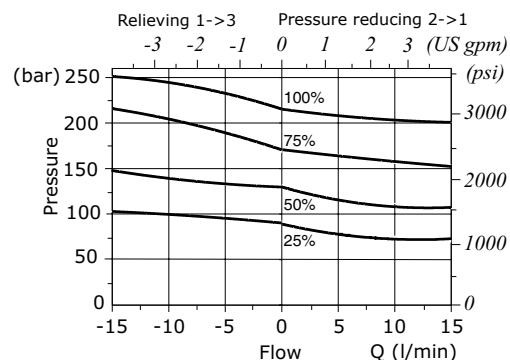



SW..A type sequence valves - 2 way

- Pressure release type
- Pilot operated
- Spool type
- From SAE10 to SAE16 cavities

Technical specifications and diagrams are measured with mineral oil of 46 cSt viscosity at 40°C (104°F) temperature.

		SW10A	SW12D	SW16A
Nominal flow		60 l/min (16 US gpm)	100 l/min (26 US gpm)	180 l/min (48 US gpm)
Max. pressure		350 bar (5100 psi)		
Oil leakage	80% of max. pressure setting	22 cm ³ /min (1.34 in ³ /min)	50 cm ³ /min (3.05 in ³ /min)	100 cm ³ /min (6.1 in ³ /min)
Fluid		mineral based oil		
Viscosity		10-200 cSt		
Max level of contamination		20/18/14 ISO4406		
Fluid temperature	with NBR seals with FPM seals	from -20°C (-4°F) to 80°C (176°F) from -20°C (-4°F) to 100°C (212°F)		
Environmental temp. for working conditions		from -20°C (-4°F) to 50°C (122°F)		
Cavity		SAE 10/2	SAE 12/2	SAE 16/2
Weight		0.20 kg (0.44 lb)	0.30 kg (0.66 lb)	0.44 kg (0.97 lb)

NOTE - For different conditions, please contact Walvoil Sales Dpt.

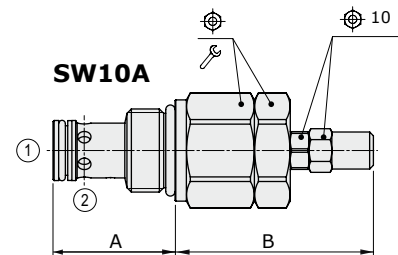
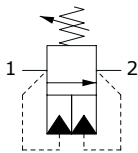

Valve type	A		B		⌀	⌘	
	mm	in	mm	in		Nm	lbft
SW10A	32.3	1.27	52.5	2.07	27	50	37
SW12D	46	1.81	52.5	2.07	32	80	59
SW16A	45.2	1.78	53	2.09	41	100	74

Ordering codes and description composition

SW10A/OS2B

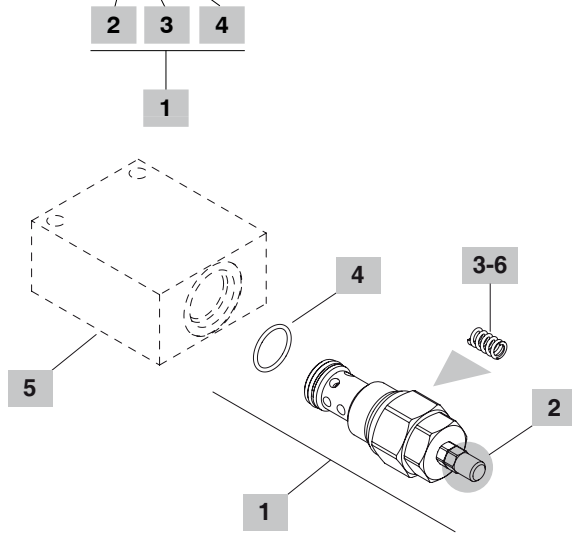

3 Pressure range

Standard setting is referred to at 5 l/min (1.32 US gpm) flow

TYPE	DESCRIPTION
1	Pressure range 10÷80 bar (145÷1160 psi); Std. setting 30 bar (435 psi), pressure increase by steps of 10 bar (145 psi) per screw turn
2	Pressure range 50÷220 bar (725÷3200 psi); Std. setting 150 bar (2200 psi), pressure increase by steps of 36 bar (520 psi) per screw turn
3	Pressure range 150÷350 bar (2200÷5100 psi); Std. setting 250 bar (3600 psi), pressure increase by steps of 90 bar (1300 psi) per screw turn

4 Seals

TYPE	DESCRIPTION
B	NBR (Buna) o-ring seals, std configuration
V	FPM (Viton) o-ring seals, contact Sales Dept.

5 Valve body

TYPE	CODE	DESCRIPTION
SAE 10/2-SAE8	3CC1020K11	Aluminium body for cavity 10 valve, SAE8 std thread
SAE 12/2-SAE10	3CC1220L11	Aluminium body for cavity 12 valve, SAE10 std thread
SAE 16/2-SAE12	3CC1020M11	Aluminium body for cavity 16 valve, SAE12 std thread

Note: aluminium body can stand up to 210 bar (3050 psi)
For steel bodies or different threading see from page 215

6 Springs

TYPE	CODE	DESCRIPTION
1	3ML1081400	Pressure range 1 - white band
2	3ML1081401	Pressure range 2 - no band
3	3ML1081402	Pressure range 3 - red band

1 Cartridges

TYPE	CODE	DESCRIPTION
SAE cavity 10/2		
SW10A/OS2B	OSW10002000	Pressure range 2
SAE cavity 12/2		
SW12D/OS2B	OSW12002005	Pressure range 2
SAE cavity 16/2		
SW16A/OS2B	OSW16002000	Pressure range 2

2 Adjustments

TYPE	DESCRIPTION
S	Screw

Rating diagrams

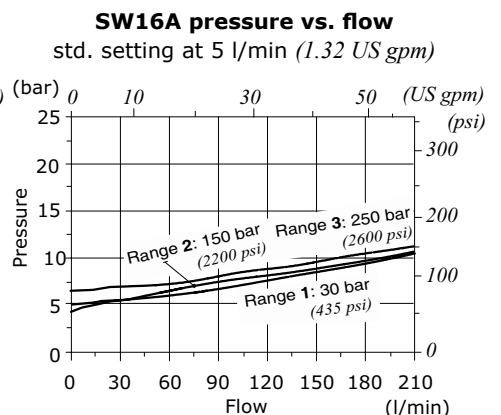
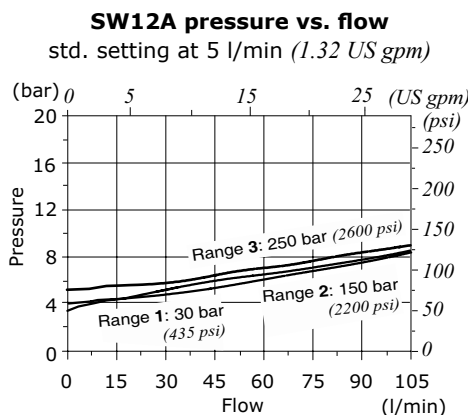
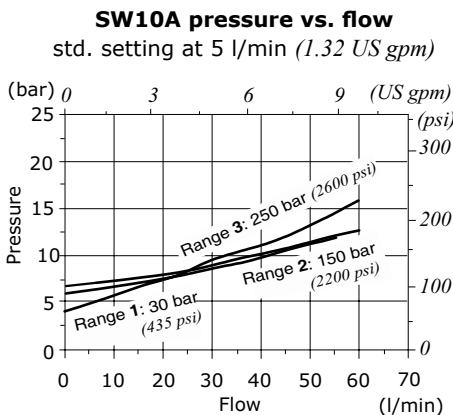



SE..A type sequence valves - 3 way

- Direct acting
- External pilot
- Poppet type
- From SAE08 to SAE10 cavities

Technical specifications and diagrams are measured with mineral oil of 46 cSt viscosity at 40°C (104°F) temperature.

	SE08A	SE10A
Nominal flow	5 l/min (1.32 US gpm)	20 l/min (5.3 US gpm)
Max. pressure	210 bar (3050 psi)	
Oil leakage	80% of max. pressure setting	0.25 cm ³ /min (0.015 in ³ /min)
Fluid	mineral based oil	
Viscosity	10-200 cSt	
Max level of contamination	20/18/14 ISO4406	
Fluid temperature	with NBR seals with FPM seals	from -20°C (-4°F) to 80°C (176°F) from -20°C (-4°F) to 100°C (212°F)
Environmental temp. for working conditions	from -20°C (-4°F) to 50°C (122°F)	
Cavity	SAE 08/3	SAE 10/3
Weight	0.28 kg (0.62 lb)	0.47 kg (1.04 lb)

NOTE - For different conditions, please contact Walvoil Sales Dpt.

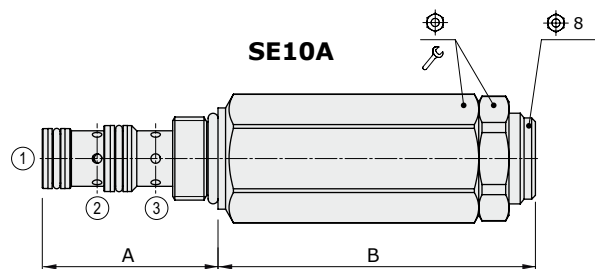
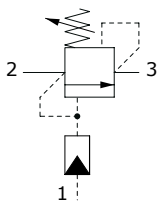

Valve type	A		B		⊕	⌘	
	mm	in	mm	in		Nm	lbft
SE08A	41	1.61	69	2.72	27	30	22
SE10A	47	1.85	95	3.74	30	50	37

Ordering codes and description composition

SE08A/1S1B

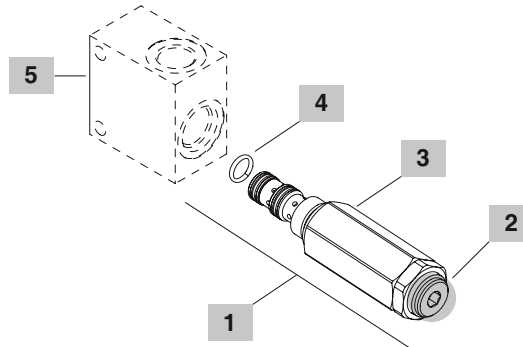
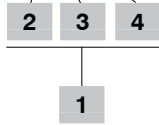

1 Cartridges

TYPE	CODE	DESCRIPTION
SAE cavity 08/3		
SE08A/1S1B	0SE08002003	With pressure range 1
SE08A/1S2B	0SE08002002	With pressure range 2
SE08A/1S3B	0SE08002001	With pressure range 3
SE08A/1S4B	0SE08002000	With pressure range 4
SAE cavity 10/3		
SE10A/1S1B	0SE10002001	With pressure range 1
SE10A/1S2B	0SE10002002	With pressure range 2
SE10A/1S3B	0SE10002000	With pressure range 3
SE10A/1S4B	0SE10002003	With pressure range 4

2 Adjustments

TYPE	DESCRIPTION
S	Screw

3 Pressure settings

Standard setting is referred to at 1 l/min (0.26 US gpm) flow

TYPE	DESCRIPTION
1	Range 5÷50 bar (72.5÷725 psi); Std. setting 30 bar (435 psi)
2	Range 20÷100 bar (290÷1450 psi); Std. setting 50 bar (725 psi)
3	Range 50÷150 bar (725÷2175 psi); Std. setting 100 bar (1450 psi)
4	Range 100÷250 bar (1450÷3600 psi); Std. setting 180 bar (2600 psi)

4 Seals

TYPE	DESCRIPTION
B	NBR (Buna) o-ring seals, std configuration
V	FPM (Viton) o-ring seals, contact Sales Dept.

5 Valve body

TYPE	CODE	DESCRIPTION
SAE 08/3-SAE6	3CC0830J11	Aluminium body for cavity 08 valve, SAE6 std thread
SAE 10/3-SAE8	3CC1030K11	Aluminium body for cavity 10 valve, SAE8 std thread

For steel bodies or different threading see from page 217

Rating diagrams

SE08A pressure drop vs. flow 2->3

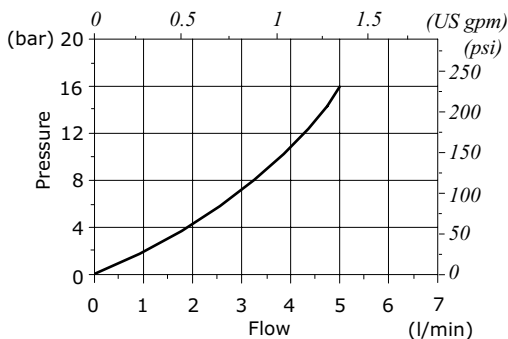

SE10A pressure drop vs. flow 2->3

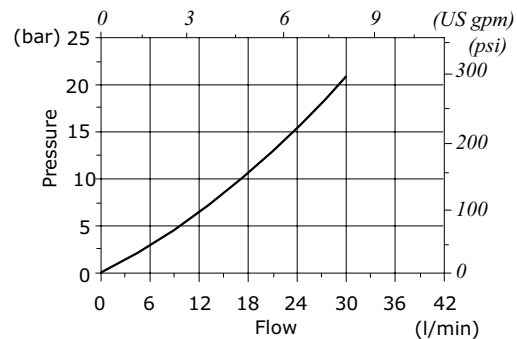



SP10A type sequence valve - 3 way

- Pilot operated
- Spool type
- Not affected by back pressure

Technical specifications and diagrams are measured with mineral oil of 46 cSt viscosity at 40°C (104°F) temperature.

SP10A		
Nominal flow		50 l/min (13 US gpm)
Max. pressure		350 bar (5100 psi)
Oil leakage	at 210 bar (3050 psi)	25 cm ³ /min (1.52 in ³ /min)
Fluid		mineral based oil
Viscosity		10-200 cSt
Max level of contamination		20/18/14 ISO4406
Fluid temperature	with NBR seals with FPM seals	from -20°C (-4°F) to 80°C (176°F) from -20°C (-4°F) to 100°C (212°F)
Environmental temp. for working conditions		from -20°C (-4°F) to 50°C (122°F)
Cavity		SAE 10/3
Weight		0.21 kg (0.46 lb)

NOTE - For different conditions, please contact Walvoil Sales Dpt.

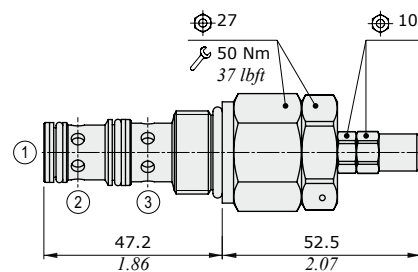
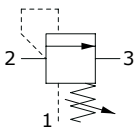

Ordering codes and description composition

SP10A/1S3B

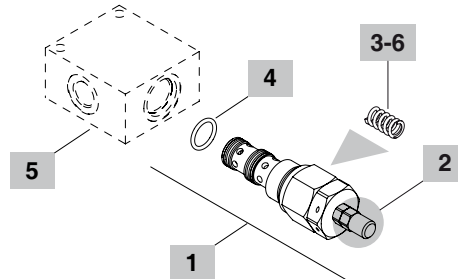
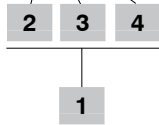

1 Cartridges

TYPE	CODE	DESCRIPTION
SAE cavity 10/3		
SP10A/1S3B	OSP10002001	Pressure range 3

2 Adjustments

TYPE	DESCRIPTION
S	Screw

3 Pressure range

Standard setting is referred to at 5 l/min (1.32 US gpm) flow

TYPE	DESCRIPTION
1	Pressure range 10÷80 bar (145÷1150 psi); Std. setting 20 bar (290 psi), pressure increase by steps of 10 bar (145 psi) per screw turn
2	Pressure range 50÷220 bar (725÷3200 psi); Std. setting 150 bar (2175 psi), pressure increase by steps of 46 bar (660 psi) per screw turn
3	Pressure range 150÷350 bar (2200÷5100 psi); Std. setting 250 bar (3600 psi), pressure increase by steps of 110 bar (1600 psi) per screw turn

4 Seals

TYPE	DESCRIPTION
B	NBR (Buna) o-ring seals, std configuration
V	FPM (Viton) o-ring seals, contact Sales Dept.

5 Valve body

TYPE	CODE	DESCRIPTION
SAE 10/3-SAE8	3CC1030K11	Aluminium body for cavity 10 valve, SAE8 std thread

Note: aluminium body can stand up to 210 bar (3050 psi)
For steel bodies or different threading see from page 217

6 Springs

TYPE	CODE	DESCRIPTION
1	3ML1081400	Pressure range 1 - white band
2	3ML1081401	Pressure range 2 - no band
3	3ML1081402	Pressure range 3 - red band

Rating diagrams

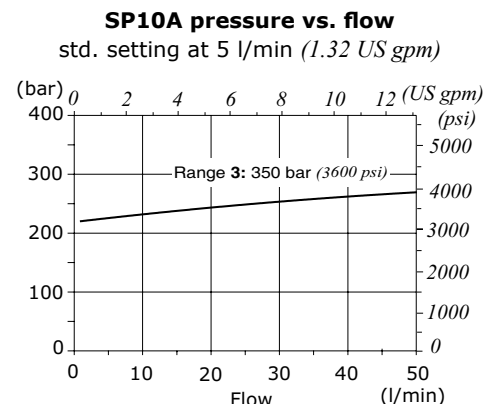
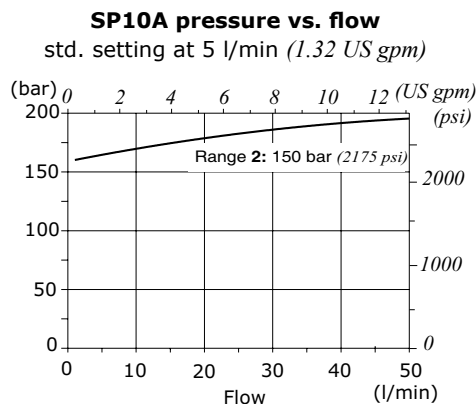
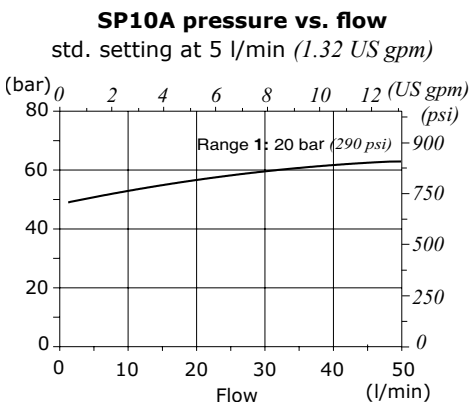



SG12A type sequence valve - 4 way

- Direct acting
- Poppet type
- External pilot and drain

Technical specifications and diagrams are measured with mineral oil of 46 cSt viscosity at 40°C (104°F) temperature.

SG12A		
Nominal flow		50 l/min (13 US gpm)
Max. pressure		300 bar (4350 psi)
Oil leakage		-
Fluid		mineral based oil
Viscosity		10-200 cSt
Max level of contamination		20/18/14 ISO4406
Fluid temperature	with NBR seals	from -20°C (-4°F) to 80°C (176°F)
	with FPM seals	from -20°C (-4°F) to 100°C (212°F)
Environmental temp. for working conditions		from -20°C (-4°F) to 50°C (122°F)
Cavity		SAE 12/4
Weight		0.52 kg (1.15 lb)

NOTE - For different conditions, please contact Walvoil Sales Dpt.

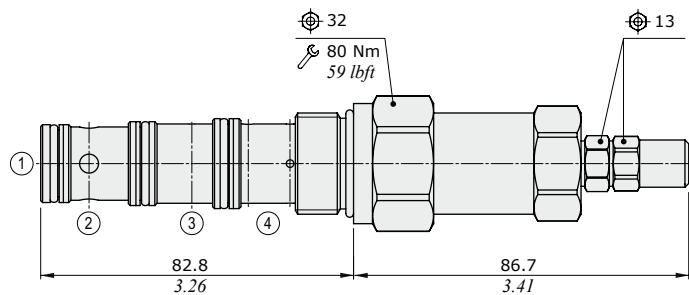
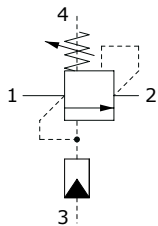

Ordering codes and description composition

SG12A/1S1B

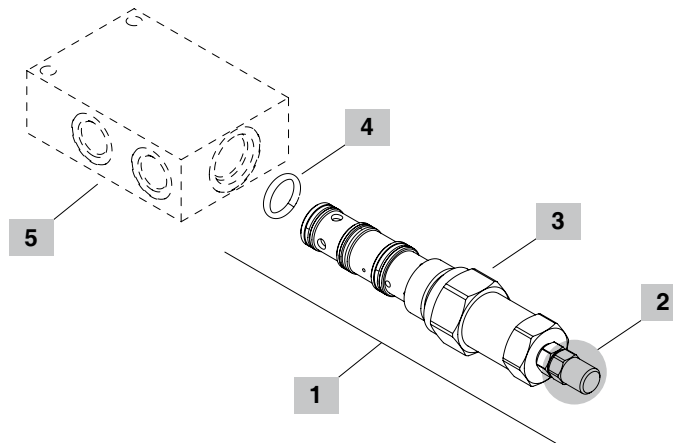
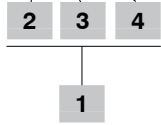

1 Cartridges

TYPE	CODE	DESCRIPTION
SAE cavity 12/4		
SG12A/1S1B	0SG12002000	Cartridge pres. sett. 1
SG12A/1S2B	0SG12002002	Cartridge pres. sett. 2
SG12A/1S3B	0SG12002001	Cartridge pres. sett. 3

2 Adjustments

TYPE	DESCRIPTION
S	Screw

3 Pressure settings

Standard setting is referred to at 1 l/min (0.26 US gpm) flow

TYPE	DESCRIPTION
1	Range 20÷100 bar (290÷1450 psi); Std. setting 50 bar (725 psi)
2	Range 50÷200 bar (725÷2900 psi); Std. setting 150 bar (2200 psi)
3	Range 100÷300 bar (1450÷4350 psi); Std. setting 250 bar (3600 psi)

4 Seals

TYPE	DESCRIPTION
B	NBR (Buna) o-ring seals, std configuration
V	FPM (Viton) o-ring seals, contact Sales Dept.

5 Valve body

TYPE	CODE	DESCRIPTION
SAE 12/4-SAE10	3CC1240L11	Aluminium body for cavity 12 valve, SAE10 std thread

Note: aluminium body can stand up to 210 bar (3050 psi)
For steel bodies or different threading see from page 219

Rating diagrams

SG12A pressure drop vs. flow 1->2

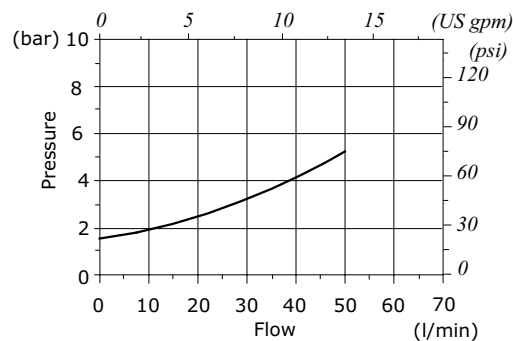



UC..A type check valves - 2 way

- Poppet type
- From SAE08 to SAE16 cavities

Technical specifications and diagrams are measured with mineral oil of 46 cSt viscosity at 40°C (104°F) temperature.

	UC08A	UC10A	UC12A	UC16A
Nominal flow	up to 20 l/min (5.3 US gpm)	up to 35 l/min (9.2 US gpm)	up to 50 l/min (13 US gpm)	up to 100 l/min (26 US gpm)
Max. pressure	350 bar (5100 psi)			
Oil leakage	at 100 bar (1450 psi)	0.25 cm ³ /min (0.015 in ³ /min)	0.25 cm ³ /min (0.015 in ³ /min)	0.25 cm ³ /min (0.015 in ³ /min)
Fluid	mineral based oil			
Viscosity	10-200 cSt			
Max level of contamination	20/18/14 ISO4406			
Fluid temperature	with NBR seals with FPM seals	from -20°C (-4°F) to 80°C (176°F) from -20°C (-4°F) to 100°C (212°F)		
Environmental temp. for working conditions	from -20°C (-4°F) to 50°C (122°F)			
Cavity	SAE 08/2	SAE 10/2	SAE 12/2	SAE 16/2
Weight	0.080 kg (0.18 lb)	0.090 kg (0.20 lb)	0.180 kg (0.40 lb)	0.370 kg (0.81 lb)

NOTE - For different conditions, please contact Walvoil Sales Dpt.

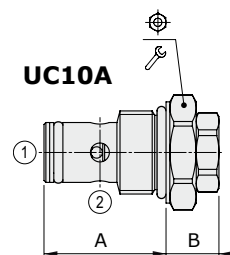

Valve type	A		B		Torque wrench icon	Nm	lbft
	mm	in	mm	in			
UC08A	27.6	1.09	15.5	0.61	24	30	22
UC10A	32.3	1.27	12.5	0.49	27	50	37
UC12A	46	1.81	14	0.55	32	80	59
UC16A	45.2	1.78	25	0.98	41	100	73

Ordering codes and description composition

UC08A/001B

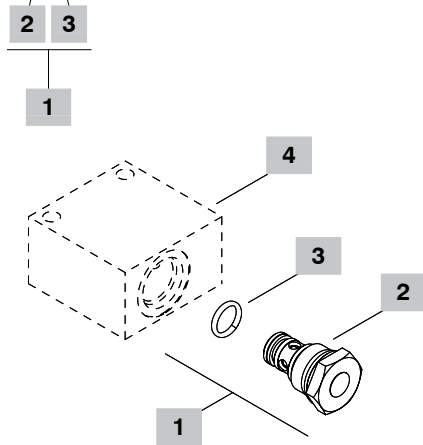

2 Opening pressure from 1 to 2

TYPE	DESCRIPTION
1	0.5 bar (7.3 psi)
2	2.5 bar (36.2 psi)
3	5 bar (72.5 psi)

3 Seals

TYPE	DESCRIPTION
B	NBR (Buna) Std configuration without addition
V	For valve with FPM (Viton) o-ring seals, contact Sales Dpt.

4 Valve body

TYPE	CODE	DESCRIPTION
SAE 08/2-SAE8	3CC0820K11	Aluminium body for cavity 08 valve, SAE8 std thread
SAE 10/2-SAE8	3CC1020K11	Aluminium body for cavity 10 valve, SAE8 std thread
SAE 12/2-SAE10	3CC1220L11	Aluminium body for cavity 12 valve, SAE10 std thread
SAE 16/2-SAE12	3CC1620M11	Aluminium body for cavity 16 valve, SAE12 std thread

Note: aluminium body can stand up to 210 bar (3050 psi)
For steel bodies or different threading see from page 215

1 Cartridges

TYPE	CODE	DESCRIPTION
SAE cavity 08/2		
UC08A/001B	0UC08002001	Opening pressure 0.5 bar (7.3 psi)
SAE cavity 10/2		
UC10A/001B	0UC10002000	Opening pressure 0.5 bar (7.3 psi)
SAE cavity 12/2		
UC12A/001B	0UC12002000	Opening pressure 0.5 bar (7.3 psi)
SAE cavity 16/2		
UC16A/001B	0UC16002001	Opening pressure 0.5 bar (7.3 psi)

Rating diagrams

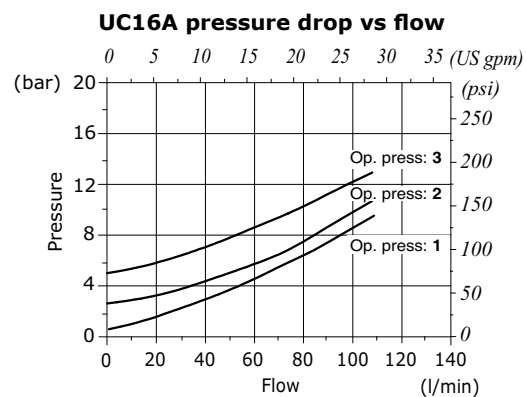
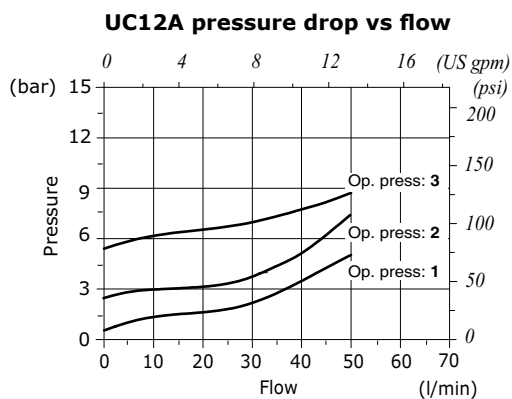
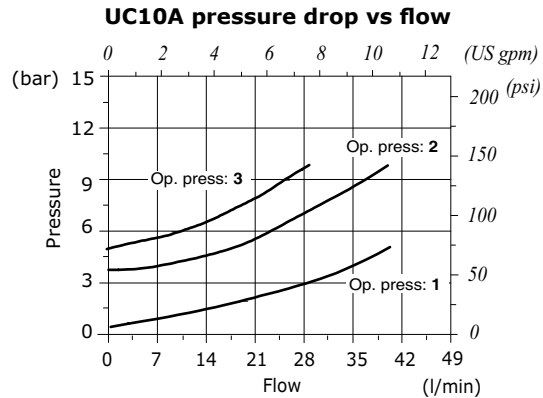
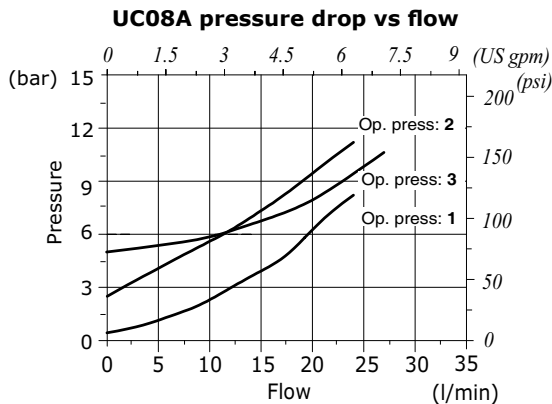



UT..A type shuttle valves - 3 way

- Shuttle valve
- Poppet type
- From SAE08 to SAE10 cavities

Technical specifications and diagrams are measured with mineral oil of 46 cSt viscosity at 40°C (104°F) temperature.

	UT08A	UT10A
Nominal flow	15 l/min (4 US gpm)	up to 20 l/min (5.3 US gpm)
Max. pressure	350 bar (5100 psi)	
Oil leakage	-	-
Fluid	mineral based oil	
Viscosity	10-200 cSt	
Max level of contamination	20/18/14 ISO4406	
Fluid temperature	with NBR seals with FPM seals	from -20°C (-4°F) to 80°C (176°F) from -20°C (-4°F) to 100°C (212°F)
Environmental temp. for working conditions	from -20°C (-4°F) to 50°C (122°F)	
Cavity	SAE 08/3	SAE 10/3
Weight	0.080 kg (0.18 lb)	0.100 kg (0.22 lb)

NOTE - For different conditions, please contact Walvoil Sales Dpt.

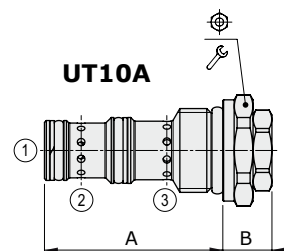
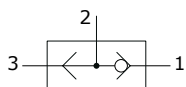

Valve type	A		B				Nm	lbft
	mm	in	mm	in				
UT08A	40.8	1.60	12.5	0.49	24	30	22	
UT10A	47.2	1.86	13	0.51	27	50	36	

Ordering codes and description composition

UT08A/000B

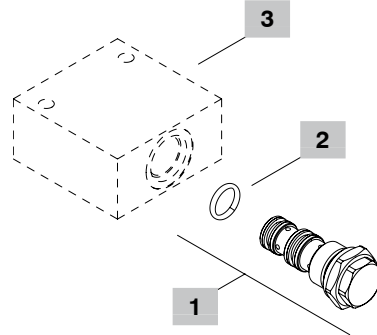
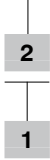

1 Cartridges

TYPE	CODE	DESCRIPTION
SAE cavity 08/3		
UT08A/000B	OUT08002000	Valve assembly
SAE cavity 10/3		
UT10A/000B	OUT10002000	Valve assembly

2 Seals

TYPE	DESCRIPTION
B	NBR (Buna) Std configuration without addition
V	For valve with FPM (Viton) o-ring seals, contact Sales Dept.

3 Valve body

TYPE	CODE	DESCRIPTION
SAE 08/3-SAE6	3CC0830J11	Aluminium body for cavity 08 valve, SAE6 std thread
SAE 10/3-SAE8	3CC1030K11	Aluminium body for cavity 10 valve, SAE8 std thread

Note: aluminium body can stand up to 210 bar (3050 psi)
For steel bodies or different threading see from page 217

Rating diagrams

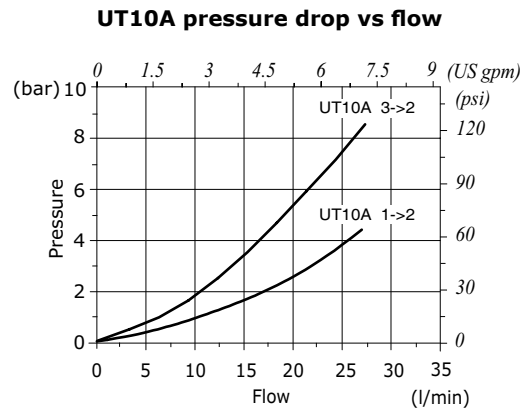
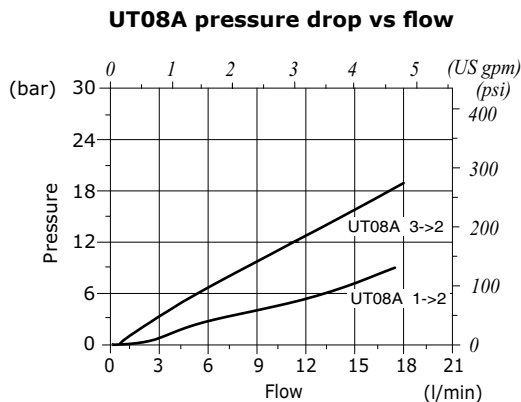



BC... type pilot operated check valves - 3 way

- Poppet type
- From SAE08 to SAE10 cavities

Technical specifications and diagrams are measured with mineral oil of 46 cSt viscosity at 40°C (104°F) temperature.

	BC08A	BC10A-B	BC10C	BC12A-B	BC16A-B
Nominal flow	15 l/min (4 US gpm)	30 l/min (8 US gpm)	60 l/min (16 US gpm)	50 l/min (13 US gpm)	100 l/min (26 US gpm)
Max. pressure	350 bar (5100 psi)				
Oil leakage at 100 bar (1450 psi)	0.25 cm ³ /min (0.015 in ³ /min)	0.25 cm ³ /min (0.015 in ³ /min)	0.25 cm ³ /min (0.015 in ³ /min)	0.25 cm ³ /min (0.015 in ³ /min)	0.25 cm ³ /min (0.015 in ³ /min)
Fluid	mineral based oil				
Viscosity	10-200 cSt				
Max level of contamination	20/18/14 ISO4406				
Fluid temperature	with NBR seals with FPM seals		from -20°C (-4°F) to 80°C (176°F) from -20°C (-4°F) to 100°C (212°F)		
Environmental temp. for working conditions	from -20°C (-4°F) to 50°C (122°F)				
Cavity	SAE 08/3	SAE 10/3	SAE 10/3	SAE 12/3	SAE 16/3
Weight	0.080 kg (0.18 lb)	0.100 kg (0.22 lb)	0.111 kg (0.24 lb)	0.230 kg (0.51 lb)	0.440 kg (0.97 lb)

NOTE - For different conditions, please contact Walvoil Sales Dpt.

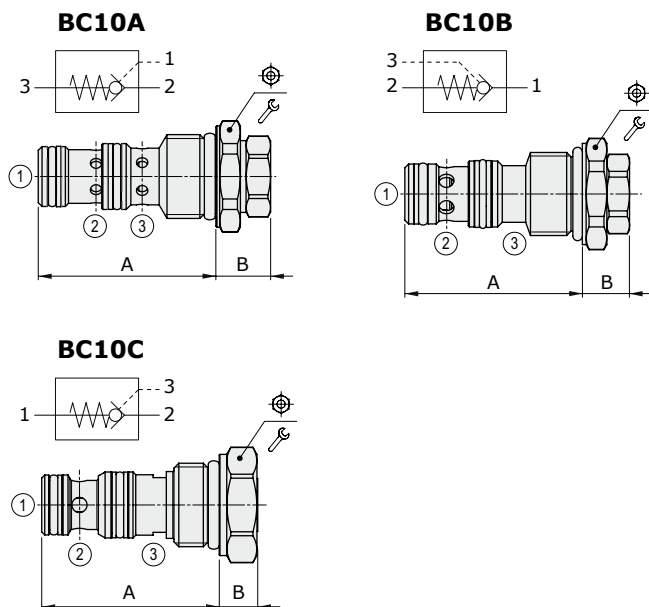

Valve type	A		B		Wrench icon	Nm	lbft	
	mm	in	mm	in				
BC..A	SAE 08/3	40.8	1.61	15.5	0.61	24	30	22
	SAE 10/3	47	1.85	11	0.43	27	50	36
	SAE 12/3	73.5	2.89	14	0.55	32	80	59
	SAE 16/3	75.4	2.97	25	0.98	41	100	73
BC..B	SAE 10/3	47	1.85	6.5	0.25	27	50	36
	SAE 12/3	73.5	2.89	14	0.55	32	80	59
BC..C	SAE 16/3	99	3.90	24	0.94	41	100	73
	SAE 10/3	47	1.85	10.2	0.40	27	50	36

Ordering codes and description composition

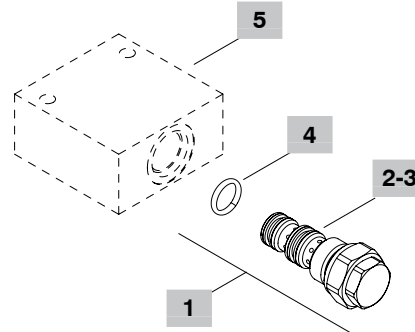
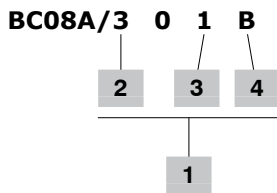

1 Cartridges

TYPE	CODE	DESCRIPTION
SAE cavity 08/3		
BC08A/301B	OBC08002000	Pilot ratio 1:2.5 Opening press. 2 to 3 = 5 bar (72.5 psi)
SAE cavity 10/3		
BC10A/301B	OBC10002001	Pilot ratio 1:3 Opening press. 2 to 3 = 5 bar (72.5 psi)
BC10B/301B	OBC10002008	Pilot ratio 1:2 Opening press. 1 to 2 = 5 bar (72.5 psi)
BC10C/401B	OBC10002011	Pilot ratio 1:4 Opening press. 2 to 1 = 5 bar (72.5 psi)
SAE cavity 12/3		
BC12A/301B	OBC12002000	Pilot ratio 1:3 Opening press. 2 to 3 = 5 bar (72.5 psi)
BC12B/301B	OBC12002005	Pilot ratio 1:3 Opening press. 1 to 2 = 5 bar (72.5 psi)
SAE cavity 16/3		
BC16A/301B	OBC16002000	Pilot ratio 1:2.5 Opening press. 2 to 3 = 5 bar (72.5 psi)
BC16B/301B	OBC16002004	Pilot ratio 1:2.5 Opening press. 1 to 2 = 5 bar (72.5 psi)

2 Pilot ratio

TYPE	DESCRIPTION
For BC..A	
BC08A/3	1:2.5
BC10A/3	1:3
BC12A/3	1:3
BC16A/3	1:2.5
For BC..B	
BC10B/3	1:2
BC12B/3	1:3
BC16B/3	1:2.5
For BC..C	
BC10B/3	1:4

3 Opening pressure from 2 to 3

TYPE	DESCRIPTION
For BC..A from 2 to 3	
1	5 bar (72.5 psi) with sealed piston
2	2.5 bar (36.2 psi) without sealed piston
For BC..B from 1 to 2	
1	5 bar (72.5 psi) with sealed piston
For BC..C from 2 to 1	
1	5 bar (72.5 psi) with seal

4 Seals

TYPE	DESCRIPTION
B	NBR (Buna) Std configuration without addition
V	For valve with FPM (Viton) o-ring seals, contact Sales Dept.

5 Valve body

TYPE	CODE	DESCRIPTION
SAE 08/3-SAE8	3CC0830K11	Aluminium body for cavity 08 valve, SAE8 std thread
SAE 10/3-SAE8	3CC1030K11	Aluminium body for cavity 10 valve, SAE8 std thread
SAE 12/3-SAE10	3CC1230L11	Aluminium body for cavity 12 valve, SAE10 std thread
SAE 16/3-SAE12	3CC1630M11	Aluminium body for cavity 16 valve, SAE12 std thread

Note: aluminium body can stand up to 210 bar (3050 psi)
For steel bodies or different threading see from page 217

Rating diagrams

BC08A pressure drop vs flow

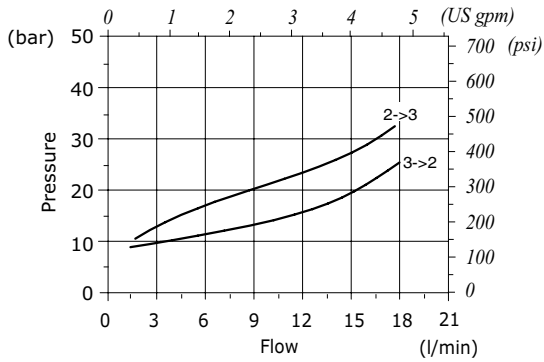

BC10A pressure drop vs flow

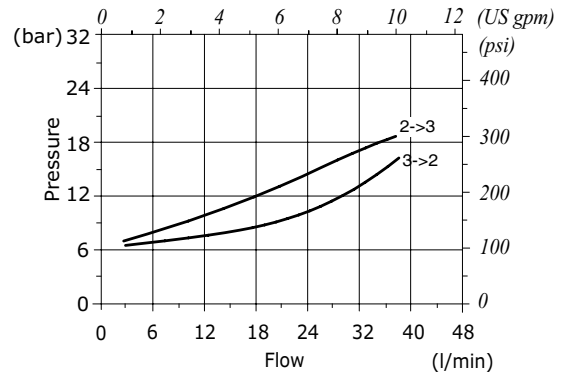

BC12A pressure drop vs flow

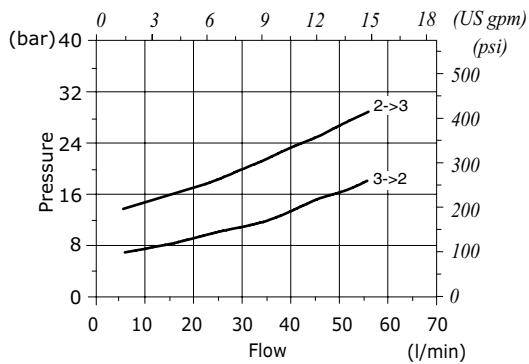

BC16A pressure drop vs flow

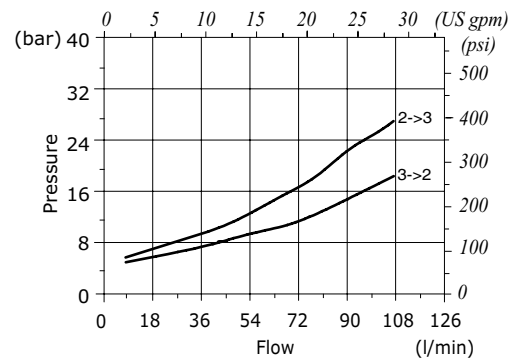

BC10B pressure drop vs flow

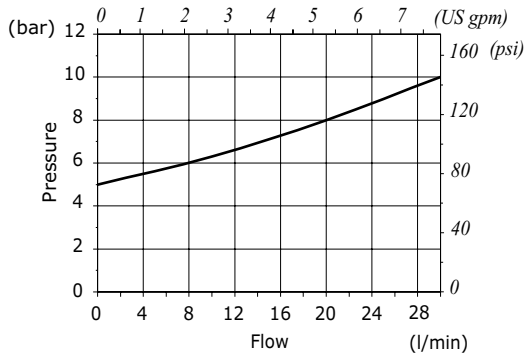

BC12B pressure drop vs flow

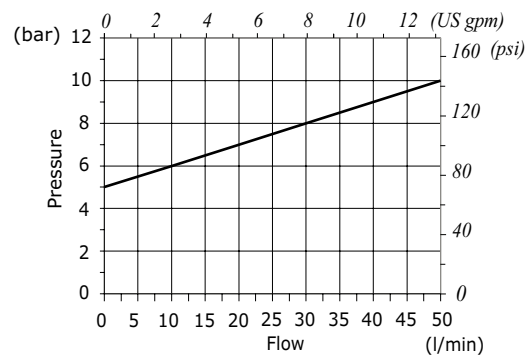

Rating diagrams

BC16B pressure drop vs flow

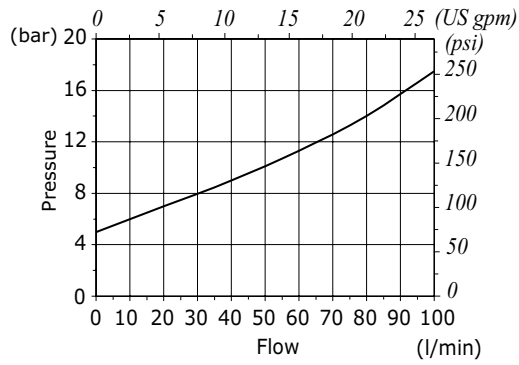

BC10C pressure drop vs flow

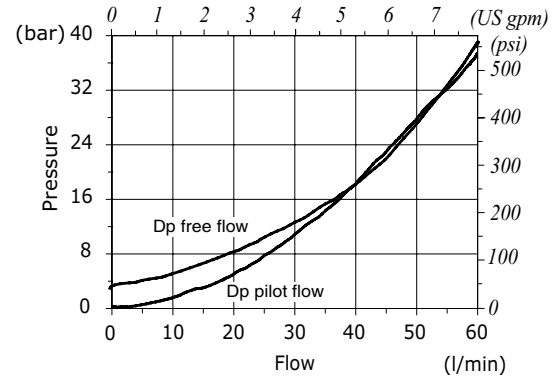



CA..A type counterbalance valves - 3 way

- For open center
- Line mounting
- From SAE10 to SAE16 cavities

Technical specifications and diagrams are measured with mineral oil of 46 cSt viscosity at 40°C (104°F) temperature.

	CA10A	CA12A	CA16A
Nominal flow	30 l/min (7.9 US gpm)	60 l/min (16 US gpm)	90 l/min (23.8 US gpm)
Max. pressure	350 bar (5100 psi)		
Oil leakage	80% of max. pressure setting	0.25 cm ³ /min (0.015 in ³ /min)	0.25 cm ³ /min (0.015 in ³ /min)
Fluid	mineral based oil		
Viscosity	10-200 cSt		
Max level of contamination	20/18/14 ISO4406		
Fluid temperature	with NBR seals with FPM seals	from -20°C (-4°F) to 80°C (176°F) from -20°C (-4°F) to 100°C (212°F)	
Environmental temp. for working conditions	from -20°C (-4°F) to 50°C (122°F)		
Cavity	SAE 10/3	SAE 12/3	SAE 16/3
Weight	0.280 kg (0.62 lb)	0.280 kg (0.62 lb)	0.670 kg (1.48 lb)

NOTE - For different conditions, please contact Walvoil Sales Dpt.

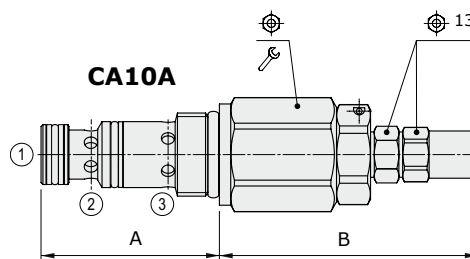
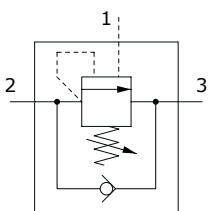

Valve type	A		B				Nm	lbft
	mm	in	mm	in				
CA10A/	4S	47.2	1.86	68.5	2.70	27	50	37
	4W	47.2	1.86	68.5	2.70	27	50	37
CA12A/	4S	73.5	2.89	62.5	2.46	32	80	59
	4W	73.5	2.89	62.5	2.46	32	80	59
CA16A/	4S	75	2.95	69.9	2.74	41	100	74
	4W	75	2.95	69.9	2.74	41	100	74

Ordering codes and description composition

CA10A/4S2B

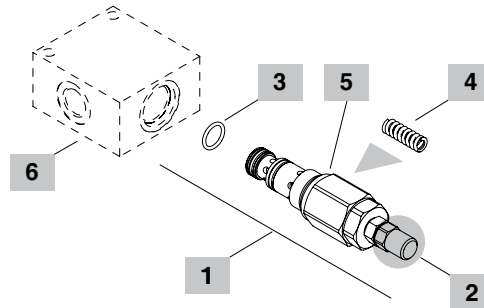
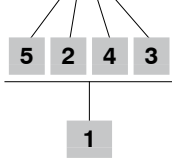

1 Cartridges

TYPE	CODE	DESCRIPTION
SAE cavity 10/3		
CA10A/4S2B	OCA10002007	Screw type adjustment, pilot ratio 1:4 pressure range 2
SAE cavity 12/3		
CA12A/4S2B	OCA12002000	Screw type adjustment, pilot ratio 1:4 pressure range 2
SAE cavity 16/3		
CA16A/4S2B	OCA16002001	Screw type adjustment, pilot ratio 1:4 pressure range 2

2 Adjustments

TYPE	DESCRIPTION
S	Screw
W	Copped adjustment

3 Seals

TYPE	DESCRIPTION
B	NBR (Buna) Std configuration without addition
V	For valve with FPM (Viton) o-ring seals, contact Sales Dept.

4 Pressure range

Standard setting is referred to 5 l/min (1.32 US gpm) flow

TYPE	CODE	DESCRIPTION
For CA10A valve		
1	3ML1092502 red band	Setting range 50-220 bar (725-3200 psi)
2	3ML1092300 red band	Setting range 180-350 bar (2600-5100 psi)
3	3ML1102800 red band	Setting range 300-700 bar (4350-10150 psi)
For CA12A valve		
1	3ML1133201 blue band	Setting range 50-220 bar (725-3200 psi)
2	3ML1133200 red band	Setting range 180-350 bar (2600-5100 psi)
3	3ML1133500 yellow band	Setting range 300-700 bar (4350-10150 psi)
For CA16A valve		
1	3ML1164000 blue band	Setting range 50-220 bar (725-3200 psi)
2	3ML1164001 red band	Setting range 180-350 bar (2600-5100 psi)
3	3ML1164002 yellow band	Setting range 300-700 bar (4350-10150 psi)

5 Pilot ratio

TYPE	DESCRIPTION
4	1:4

6 Valve body

TYPE	CODE	DESCRIPTION
SAE 10/3-SAE8	3CC1030K11	Aluminium body for cavity 10 valve, SAE8 std thread
SAE 12/3-SAE10	3CC1230L11	Aluminium body for cavity 12 valve, SAE10 std thread
SAE 16/3-SAE12	3CC1630M11	Aluminium body for cavity 16 valve, SAE12 std thread

Note: aluminium body can stand up to 210 bar (3050 psi)
For steel bodies or different threading see from page 217

Rating diagrams

CA10A pressure drop vs flow

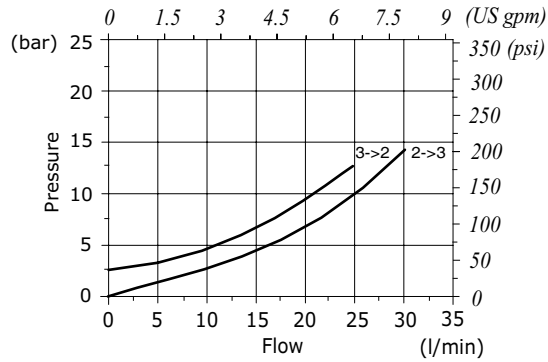

CA12A pressure drop vs flow

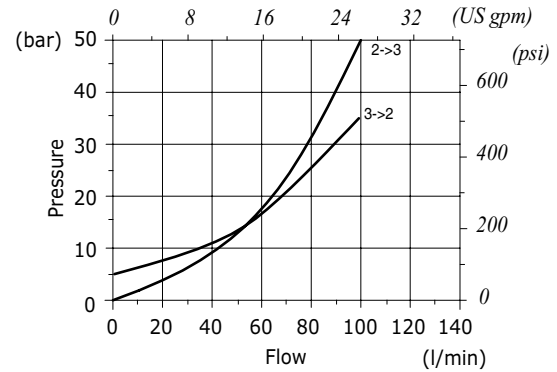

CA16A pressure drop vs flow

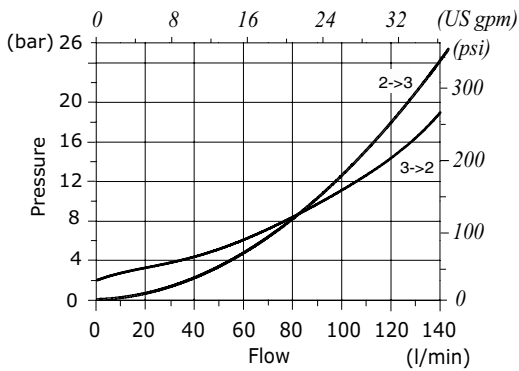





CC..A type counterbalance valves - 3 way

- For closed center
- Line mounting
- Non affected by back pressure
- From SAE10 to SAE20 cavities

Technical specifications and diagrams are measured with mineral oil of 46 cSt viscosity at 40°C (104°F) temperature.

		CC10A	CC12A	CC16A	CC20A
Nominal flow		30 l/min (7.9 US gpm)	60 l/min (16 US gpm)	90 l/min (24 US gpm)	150 l/min (39.6 US gpm)
Max. pressure		350 bar (5100 psi)			
Oil leakage	80% of max. pressure setting	0.25 cm ³ /min (0.015 in ³ /min)	0.25 cm ³ /min (0.015 in ³ /min)	0.25 cm ³ /min (0.015 in ³ /min)	0.25 cm ³ /min (0.015 in ³ /min)
Fluid		mineral based oil			
Viscosity		10-200 cSt			
Max level of contamination		20/18/14 ISO4406			
Fluid temperature	with NBR seals with FPM seals	from -20°C (-4°F) to 80°C (176°F) from -20°C (-4°F) to 100°C (212°F)			
Environmental temp. for working conditions		from -20°C (-4°F) to 50°C (122°F)			
Cavity		SAE 10/3	SAE 12/3	SAE 16/3	SAE 20/3
Weight		0.280 kg (0.62 lb)	0.380 kg (0.84 lb)	0.720 kg (1.59 lb)	1.200 kg (2.64 lb)

NOTE - For different conditions, please contact Walvoil Sales Dpt.

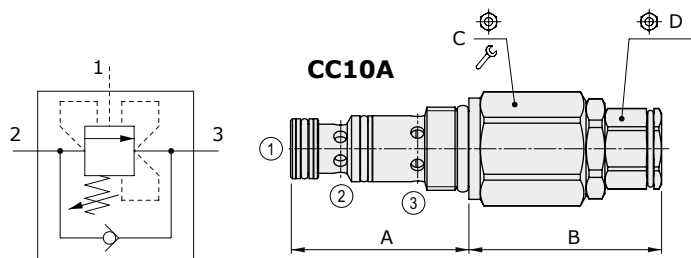

Valve type	A		B		C		D		
	mm	in	mm	in	Nm	lbft			
CC10A/	4S	47.2	1.86	51	2.01	27	50	37	19
	W	47.2	1.86	51	2.01	27	50	37	19
CC12A/	4S	73.5	2.89	60	2.36	32	80	59	24
	4W	73.5	2.89	60	2.36	32	80	59	24
CC16A/	4S	75	2.95	69	2.72	41	100	74	27
	4W	75	2.95	69	2.72	41	100	74	27
CC20A/	4S	99.5	3.92	83.5	3.29	46	100	74	36
	4W	99.5	3.92	83.5	3.29	46	100	74	36

Ordering codes and description composition

CC10A/4S2B

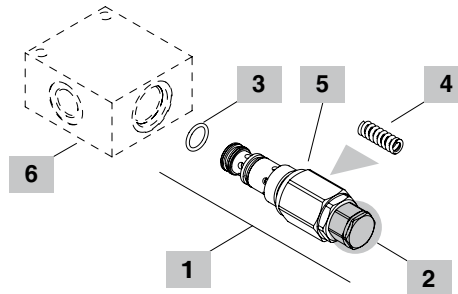
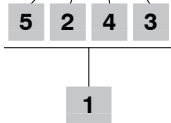

1 Cartridges

TYPE	CODE	DESCRIPTION
SAE cavity 10/3		
CC10A/4S2B	OCC10002001	Screw type adjustment, pilo ratio 1:4 pressure range 2
SAE cavity 12/3		
CC12A/4S2B	OCC12002000	Screw type adjustment, pilo ratio 1:4 pressure range 2
SAE cavity 16/3		
CC16A/4S2B	OCC16002001	Screw type adjustment, pilo ratio 1:4 pressure range 2
SAE cavity 20/3		
CC20A/4S0B	OCC20002001	Screw type adjustment. Setting range 20-85 bar (290-1230 psi) and standard setting 50 bar (725) at 5 l/min (1.3 US gpm)
CC20A/4S1B	OCC20002000	Screw type adjustment. Pilot ratio 1:4 Setting range 50-220 bar (725-3200 psi) and standard setting 150 bar (2170) at 5 l/min (1.3 US gpm)
CC20A/4S2B	OCC20002002	Screw type adjustment. Pilot ratio 1:4 Setting range 100-300 bar (1450-4350 psi) and std. setting 150 bar (2170) at 5 l/min (1.3 US gpm)

2 Adjustments

TYPE	DESCRIPTION
S	Screw
W	Copped adjustment

3 Seals

TYPE	DESCRIPTION
B	NBR (Buna) Std configuration without addition
V	For valve with FPM (Viton) o-ring seals, contact Sales Dept.

4 Pressure setting springs

Standard setting is referred to 5 l/min (1.32 US gpm) flow

TYPE	CODE	DESCRIPTION
For CC10A valve		
1	3ML1092502 red band	Setting range 50-220 bar (725-3200 psi)
2	3ML1092300 red band	Setting range 180-350 bar (2600-5100 psi)
3	3ML1102800 red band	Setting range 300-700 bar (4350-10150 psi)
For CC12A valve		
1	3ML1133201 blue band	Setting range 50-220 bar (725-3200 psi)
2	3ML1133200 red band	Setting range 180-350 bar (2600-5100 psi)
3	3ML1133500 yellow band	Setting range 300-700 bar (4350-10150 psi)
For CC16A valve		
1	3ML1164000 blue band	Setting range 50-220 bar (725-3200 psi)
2	3ML1164001 red band	Setting range 180-350 bar (2600-5100 psi)
3	3ML1164002 yellow band	Setting range 300-700 bar (4350-10150 psi)

5 Pilot ratio

TYPE	DESCRIPTION
4	1:4

6 Valve body

TYPE	CODE	DESCRIPTION
SAE 10/3-SAE8	3CC1030K11	Aluminium body for cavity 10 valve, SAE8 std thread
SAE 12/3-SAE10	3CC1230L11	Aluminium body for cavity 12 valve, SAE10 std thread
SAE 16/3-SAE12	3CC1630M11	Aluminium body for cavity 16 valve, SAE12 std thread
SAE 20/3-G 1	3CC2030F21	Steel body for cavity 20 valve, G1 std thread

Note: aluminium body can stand up to 210 bar (3050 psi)
For steel bodies or different threading see from page 217

Rating diagrams

CC10A pressure drop vs flow

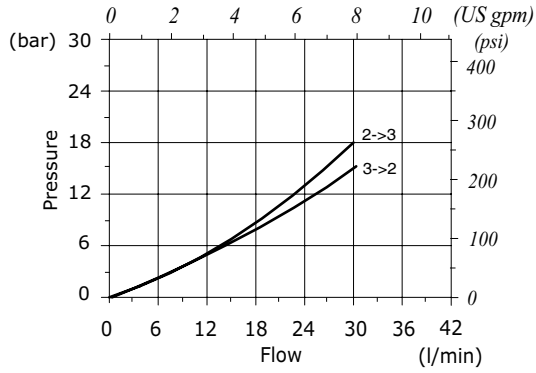

CC12A pressure drop vs flow

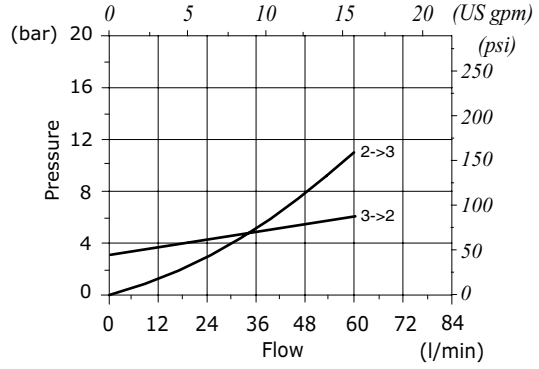

CC16A pressure drop vs flow

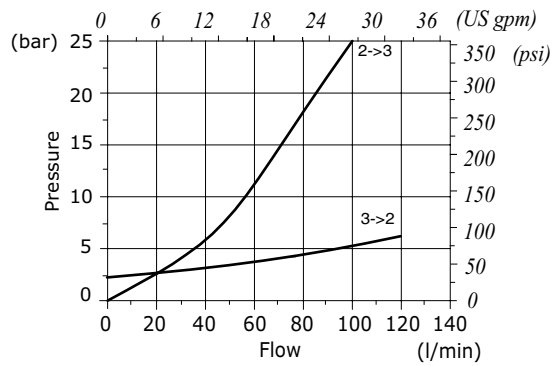

CC20A pressure drop vs flow

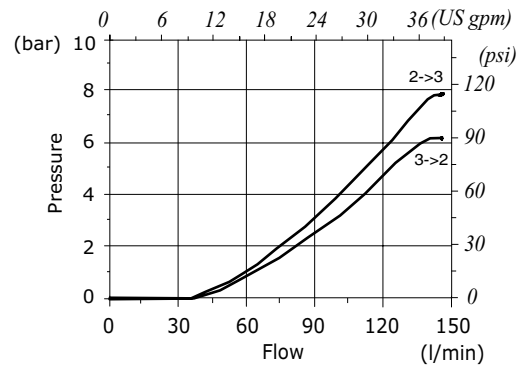



NB..A type flow restrictor - 2 way

- Adjustable type
- From SAE08 to SAE16 cavities

Technical specifications and diagrams are measured with mineral oil of 46 cSt viscosity at 40°C (104°F) temperature.

	NB08A	NB10A	NB12A	NB16A
Nominal flow	15 l/min (3.9 US gpm)	30 l/min (7.9 US gpm)	60 l/min (16 US gpm)	100 l/min (26 US gpm)
Max. pressure	350 bar (5100 psi)			
Fluid	mineral based oil			
Viscosity	10-200 cSt			
Max level of contamination	20/18/14 ISO4406			
Fluid temperature	with NBR seals with FPM seals	from -20°C (-4°F) to 80°C (176°F) from -20°C (-4°F) to 100°C (212°F)		
Environmental temp. for working conditions	from -20°C (-4°F) to 50°C (122°F)			
Cavity	SAE 08/2	SAE 10/2	SAE 12/2	SAE 16/2
Weight	0.180 kg (0.40 lb)	0.200 kg (0.44 lb)	0.280 kg (0.62 lb)	0.500 kg (1.10 lb)

NOTE - For different conditions, please contact Walvoil Sales Dpt.

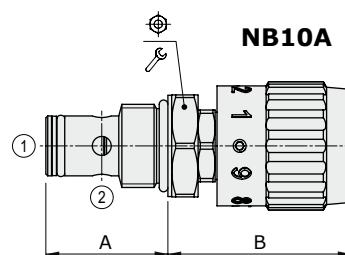
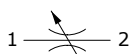

Valve type	A		B				Nm	lbft
	mm	in	mm	in				
NB08A/AM	27.6	1.09	52	2.05	24	30	22	
NB10A/AM	32.3	1.27	48	1.89	27	50	36	
NB12A/AM	46	1.81	49.2	1.94	32	80	59	
NB16A/AM	45.2	1.79	68.8	2.71	41	100	73	

For dimensions with different type of adjustment see page 212

Ordering codes and description composition

NB08A/AM0B

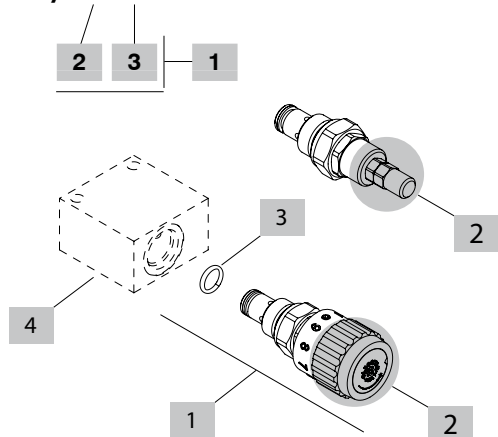

2 Adjustments

TYPE	DESCRIPTION
S	Screw
M	Handknob calibrated
W	Copped adjustment

3 Seals

TYPE	DESCRIPTION
B	NBR (Buna) Std configuration without addition
V	For valve with FPM (Viton) o-ring seals, contact Sales Dept.

4 Valve body

TYPE	CODE	DESCRIPTION
SAE 08/2-SAE8	3CC0820K11	Aluminium body for cavity 08 valve, SAE8 std thread
SAE 10/2-SAE8	3CC1020K11	Aluminium body for cavity 10 valve, SAE8 std thread
SAE 12/2-SAE10	3CC1220L11	Aluminium body for cavity 12 valve, SAE10 std thread
SAE 16/2-SAE12	3CC1620M11	Aluminium body for cavity 16 valve, SAE12 std thread

Note: aluminium body can stand up to 210 bar (3050 psi)
For steel bodies or different threading see from page 215

1 Cartridges

TYPE	CODE	DESCRIPTION
SAE cavity 08/2		
NB08A/AM0B	ONB08002000	Handknob adjustment
NB08A/AS0B	ONB08002001	Screw type adjustment
SAE cavity 10/2		
NB10A/AM0B	ONB10002003	Handknob adjustment
NB10A/AS0B	ONB10002001	Screw type adjustment
SAE cavity 12/2		
NB12A/AM0B	ONB12002002	Handknob adjustment
NB12A/AS0B	ONB12002001	Screw type adjustment
SAE cavity 16/2		
NB16A/AM0B	ONB16002000	Handknob adjustment

Rating diagrams

NB08A: pressure drop vs flow 1->2 - 2->1, fully open

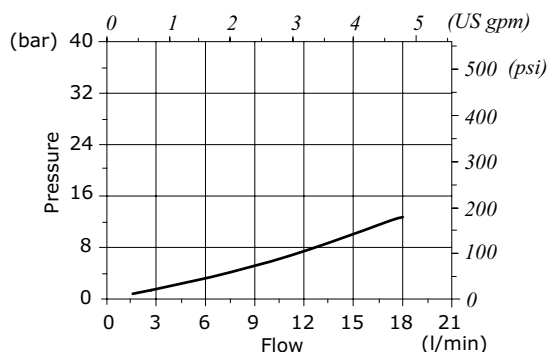

NB10A: pressure drop vs flow 1->2 - 2->1, fully open

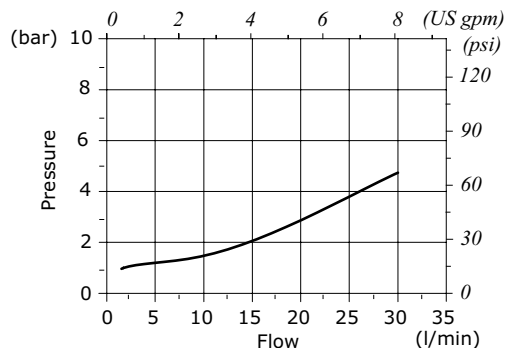

NB12A: pressure drop vs flow 1->2 - 2->1, fully open

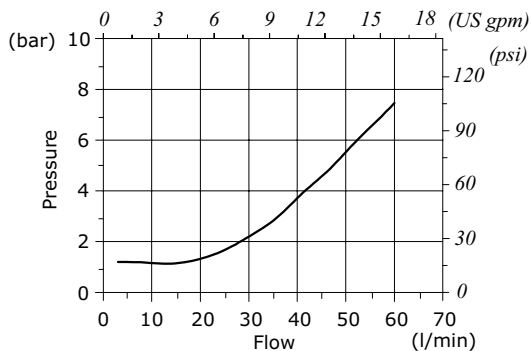

NB16A: pressure drop vs flow 1->2 - 2->1, fully open

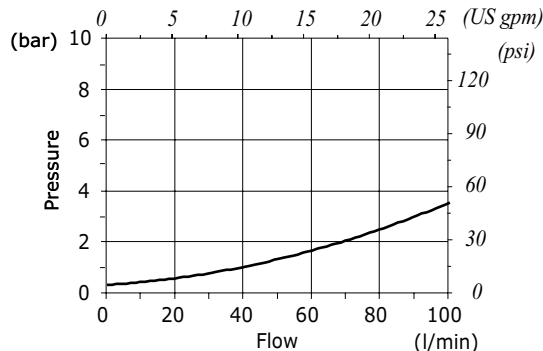



NU..A type flow restrictor - 2 way

- Adjustable type
- Free return line
- From SAE08 to SAE16 cavities

Technical specifications and diagrams are measured with mineral oil of 46 cSt viscosity at 40°C (104°F) temperature.

	NU08A	NU10A	NU12A	NU16A
Nominal flow	15 l/min (3.9 US gpm)	30 l/min (7.9 US gpm)	60 l/min (16 US gpm)	100 l/min (26 US gpm)
Max. pressure	350 bar (5100 psi)			
Fluid	mineral based oil			
Viscosity	10-200 cSt			
Max level of contamination	20/18/14 ISO4406			
Fluid temperature	with NBR seals with FPM seals	from -20°C (-4°F) to 80°C (176°F) from -20°C (-4°F) to 100°C (212°F)		
Environmental temp. for working conditions	from -20°C (-4°F) to 50°C (122°F)			
Cavity	SAE 08/2	SAE 10/2	SAE 12/2	SAE 16/2
Weight	0.240 kg (0.53 lb)	0.290 kg (0.64 lb)	0.400 kg (0.88 lb)	0.550 kg (1.21 lb)

NOTE - For different conditions, please contact Walvoil Sales Dpt.

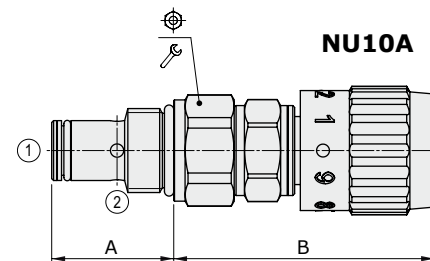
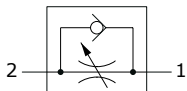

Valve type	A		B				Nm	lbft
	mm	in	mm	in				
NU08A/AM	27.6	1.09	66.5	2.62	24	30	22	
NU10A/AM	32.3	1.27	68	2.68	27	50	36	
NU12A/AM	46	1.81	69	2.72	32	80	59	
NU16A/AM	45.2	1.79	66.9	2.63	41	100	73	

For dimensions with different type of adjustment see page 212

Ordering codes and description composition

NU08A/AM1B

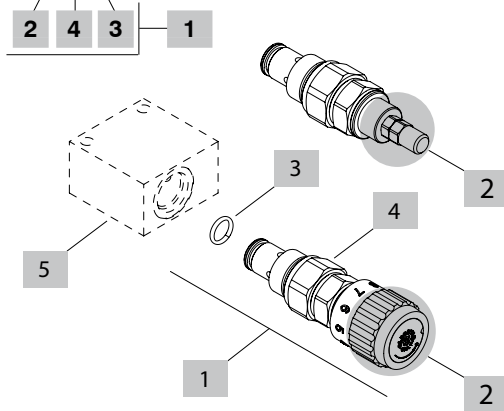

2 Adjustments

TYPE	DESCRIPTION
S	Screw
M	Handknob calibrated
W	Copped adjustment

3 Seals

TYPE	DESCRIPTION
B	NBR (Buna) Std configuration without addition
V	For valve with FPM (Viton) o-ring seals, contact Sales Dept.

4 Opening pressure check valve from 1 to 2

TYPE	DESCRIPTION
1	0.5 bar (7.3 psi)

5 Valve body

TYPE	CODE	DESCRIPTION
SAE 08/2-SAE8	3CC0820K11	Aluminium body for cavity 08 valve, SAE8 std thread
SAE 10/2-SAE8	3CC1020K11	Aluminium body for cavity 10 valve, SAE8 std thread
SAE 12/2-SAE10	3CC1220L11	Aluminium body for cavity 12 valve, SAE10 std thread
SAE 16/2-SAE12	3CC1620M11	Aluminium body for cavity 16 valve, SAE12 std thread

Note: aluminium body can stand up to 210 bar (3050 psi)
For steel bodies or different threading see from page 215

1 Cartridges

TYPE	CODE	DESCRIPTION
SAE cavity 08/2		
NU08A/AM1B	0NU08002000	Handknob adjustment
NU08A/AS1B	0NU08002001	Screw type adjustment
SAE cavity 10/2		
NU10A/AM1B	0NU10002000	Handknob adjustment
NU10A/AS1B	0NU10002001	Screw type adjustment
SAE cavity 12/2		
NU12A/AM1B	0NU12002000	Handknob adjustment
NU12A/AS1B	0NU12002001	Screw type adjustment
SAE cavity 16/2		
NU16A/AM1B	0NU16002000	Handknob adjustment

Rating diagrams

NU08A pressure drop vs flow

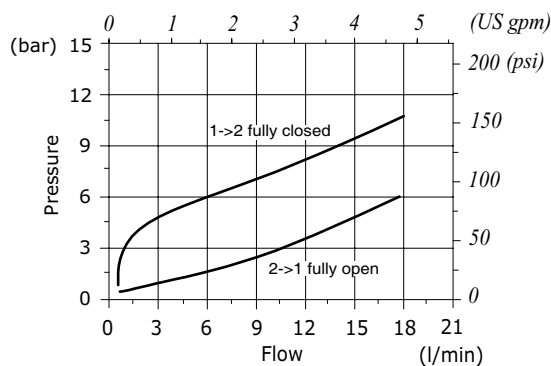

NU10A pressure drop vs flow

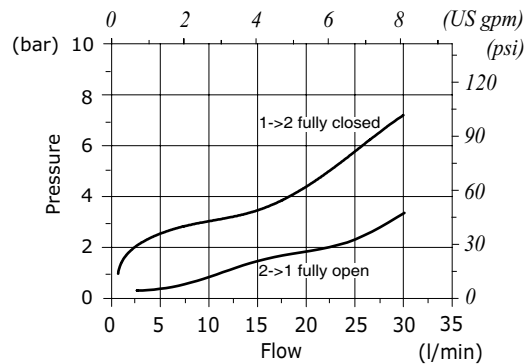

NU12A pressure drop vs flow

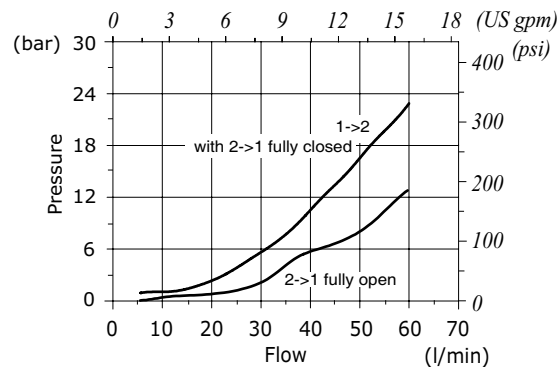

NU16A pressure drop vs flow

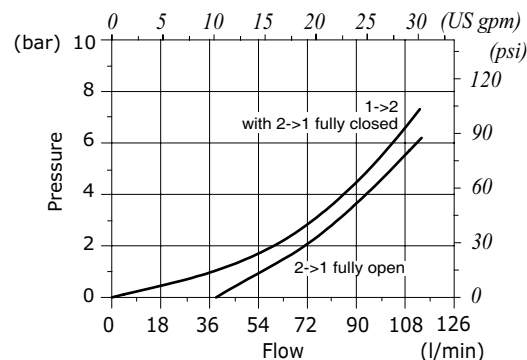



NT..A type flow restrictor - 2 way

- Adjustable type
- With reverse free flow check
- From SAE08 to SAE16 cavities

Technical specifications and diagrams are measured with mineral oil of 46 cSt viscosity at 40°C (104°F) temperature.

	NT08A	NT10A	NT12A	NT16A
Nominal flow	15 l/min (3.9 US gpm)	30 l/min (7.9 US gpm)	60 l/min (16 US gpm)	100 l/min (26 US gpm)
Max. pressure	350 bar (5100 psi)			
Fluid	mineral based oil			
Viscosity	10-200 cSt			
Max level of contamination	20/18/14 ISO4406			
Fluid temperature	with NBR seals with FPM seals	from -20°C (-4°F) to 80°C (176°F) from -20°C (-4°F) to 100°C (212°F)		
Environmental temp. for working conditions	from -20°C (-4°F) to 50°C (122°F)			
Cavity	SAE 08/2	SAE 10/2	SAE 12/2	SAE 16/2
Weight	0.240 kg (0.53 lb)	0.290 kg (0.64 lb)	0.400 kg (0.88 lb)	0.550 kg (1.21 lb)

NOTE - For different conditions, please contact Walvoil Sales Dpt.

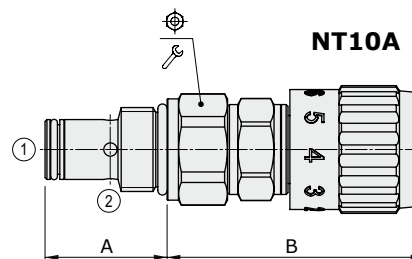
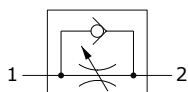

Valve type	A		B				Nm	lbft
	mm	in	mm	in				
NT08A/AM	27.6	1.09	67.5	2.66	24	30	22	
NT10A/AM	32.3	1.27	68	2.68	27	50	36	
NT12A/AM	46	1.81	69	2.72	32	80	59	
NT16A/AM	45.2	1.79	68.9	2.71	41	100	74	

For dimensions with different type of adjustment see page 212

Ordering codes and description composition

NT08A/AM1B

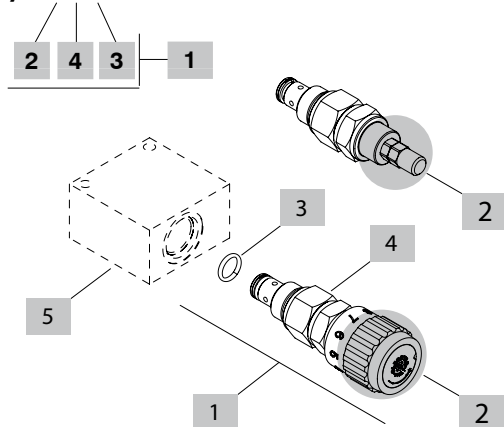

2 Adjustments

TYPE	DESCRIPTION
S	Screw
M	Handknob calibrated
W	Copped adjustment

3 Seals

TYPE	DESCRIPTION
B	NBR (Buna) Std configuration without addition
V	For valve with FPM (Viton) o-ring seals, contact Sales Dept.

4 Opening pressure check valve from 1 to 2

TYPE	DESCRIPTION
1	0.5 bar (7.3 psi)

5 Valve body

TYPE	CODE	DESCRIPTION
SAE 08/2-SAE8	3CC0820K11	Aluminium body for cavity 08 valve, SAE8 std thread
SAE 10/2-SAE8	3CC1020K11	Aluminium body for cavity 10 valve, SAE8 std thread
SAE 12/2-SAE10	3CC1220L11	Aluminium body for cavity 12 valve, SAE10 std thread
SAE 16/2-SAE12	3CC1620M11	Aluminium body for cavity 16 valve, SAE12 std thread

Note: aluminium body can stand up to 210 bar (3050 psi)
For steel bodies or different threading see from page 215

1 Cartridges

TYPE	CODE	DESCRIPTION
SAE cavity 08/2		
NT08A/AM1B	ONT08002000	Handknob adjustment
NT08A/AS1B	ONT08002001	Screw type adjustment
SAE cavity 10/2		
NT10A/AM1B	ONT10002000	Handknob adjustment
NT10A/AS1B	ONT10002001	Screw type adjustment
SAE cavity 12/2		
NT12A/AM1B	ONT12002000	Handknob adjustment
NT12A/AS1B	ONT12002001	Screw type adjustment
SAE cavity 16/2		
NT16A/AM1B	ONT16002000	Handknob adjustment

Rating diagrams

NT08A pressure drop vs flow

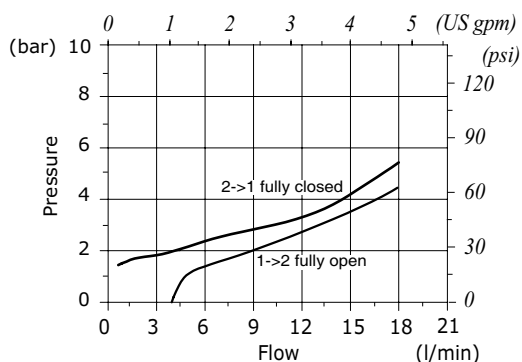

NT10A pressure drop vs flow

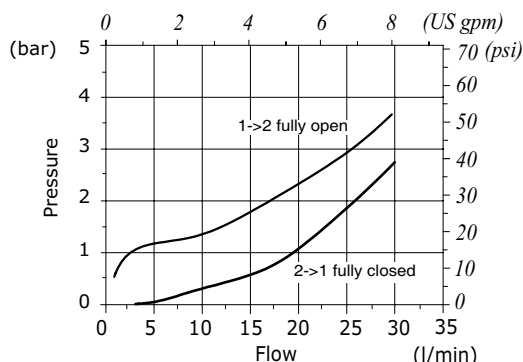

NT12A pressure drop vs flow

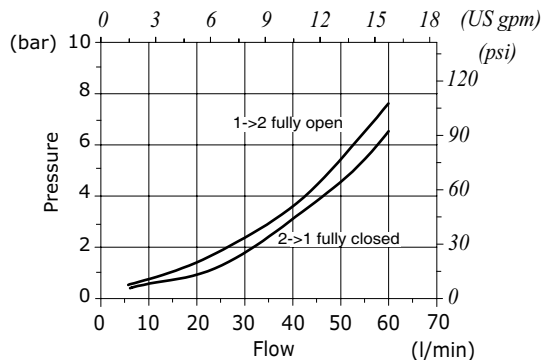

NT16A pressure drop vs flow

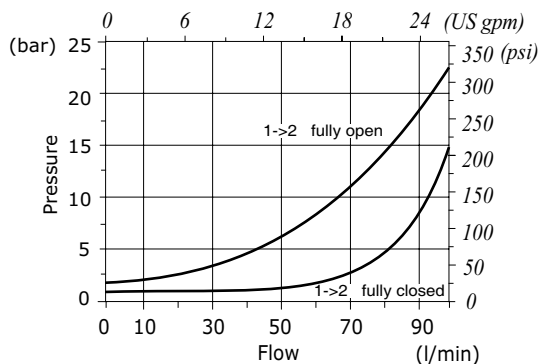



EE..X type flow restrictor - 2 way

- Solenoid proportional type
- To be combined with an external compensator
- SAE10 and SAE12 cavities

Technical specifications and diagrams are measured with mineral oil of 46 cSt viscosity at 40°C (104°F) temperature.

	EE10X	EE12X	
Nominal flow ⁽¹⁾	with 10 bar (145 psi) stand-by	40 l/min (10.6 US gpm)	60 l/min (15.8 US gpm)
Max. pressure		315 bar (4600 psi)	315 bar (4600 psi)
Oil leakage	at 150 bar (2175 psi)	150 cm ³ /min (9.1 in ³ /min)	200 cm ³ /min (9.1 in ³ /min)
Fluid		mineral based oil	
Viscosity		12-200 cSt	
Max level of contamination		18/16/13 ISO4406	
Fluid temperature	with NBR seals with FPM seals	from -20°C (-4°F) to 80°C (176°F)	from -20°C (-4°F) to 100°C (212°F)
Environmental temp. for working conditions		from -20°C (-4°F) to 50°C (122°F)	
Cavity		SAE 10/2	SAE 12/2
Coil type ⁽²⁾		BQP19 or BH	
Nominal voltages		12 VDC - 24 VDC ± 10%	
Power rating		22,8 W (12 VDC) 22,5 W (24 VDC)	
Max control current		12 V -> 1.25 A - 24 V -> 0.63 A (BQP19) 12 V -> 1.70 A - 24 V -> 0.85 A (BH)	
Dither frequency		150 Hz	
Weight		0.3 kg (0.66 lb) kg	

NOTE - For different conditions, please contact Walvoil Sales Dpt. - ⁽¹⁾ Values are checked with cartridge in parallel with compensator - ⁽²⁾ For coils further features see from page 206.

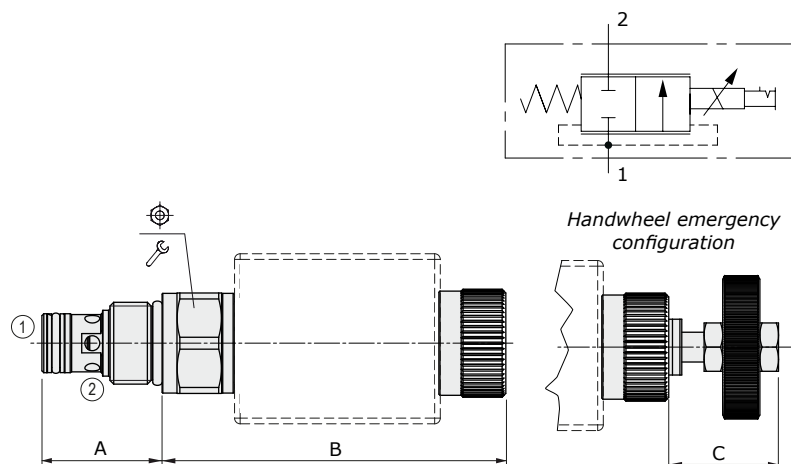

Valve type	A		B		C		⊕	⊕	
	mm	in	mm	in	mm	in			
EE10X	32.3	1.27	92.4	3.64	29.5	1.16	27	50	37
EE12X	45	1.77	94.9	3.74	29.5	1.16	32	80	59

For dimensions with different type of emergency see page 213

Ordering codes and description composition

EE10X/22NB

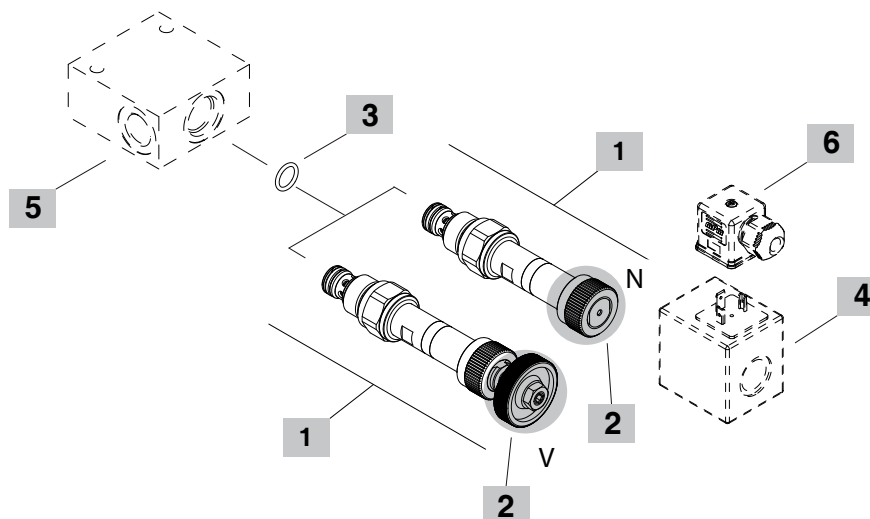
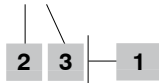

1 Cartridges

TYPE	CODE	DESCRIPTION
SAE cavity 10/2		
EE10X/22NB	0EE10002009	Without emergency
EE10X/22VB	0EE10002008	Handwheel emergency
SAE cavity 12/2		
EE12X/20NB	0EE12002007	Without emergency
EE12X/20VB	0EE12002009	Handwheel emergency

2 Emergency

TYPE	DESCRIPTION
N	Without emergency
V	Handknob emergency

3 Seals

TYPE	DESCRIPTION
B	NBR (Buna) Std configuration without addition
V	For valve with FPM (Viton) o-ring seals, contact Sales Dept.

4 Coils

TYPE	CODE	DESCRIPTION
BQP19 12VDC	4SL5000126	Coil 12VDC-ISO4400

For complete coils list see from page 206
It is possible also combine coils BH

5 Valve body

TYPE	CODE	DESCRIPTION
SAE 10/2-SAE8	3CC1020K11	Aluminium body for cavity 10 valve, SAE8 std thread
SAE 12/2-SAE10	3CC1220L11	Aluminium body for cavity 12 valve, SAE10 std thread

Note: aluminium body can stand up to 210 bar (3050 psi)
For steel bodies or different threading see from page 215

6 Connector

TYPE	CODE	DESCRIPTION
ISO4400	4CN1009995	Connector

For complete connectors list see from page 206

Curve caratteristiche

EE10X
flow regulating vs. % max. control current

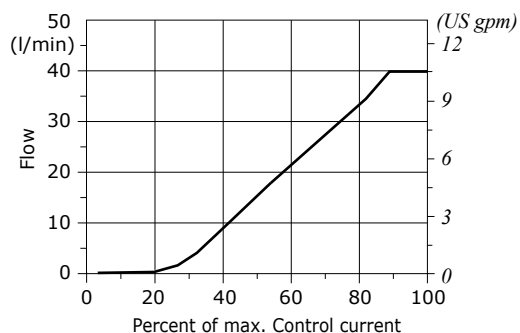

EE10X
*pressure compensation diagram 1→2

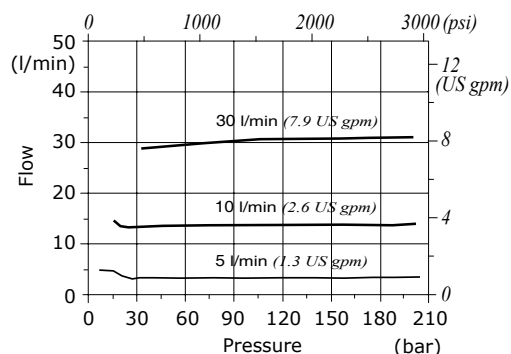

EE12X
flow regulating vs. % max. control current

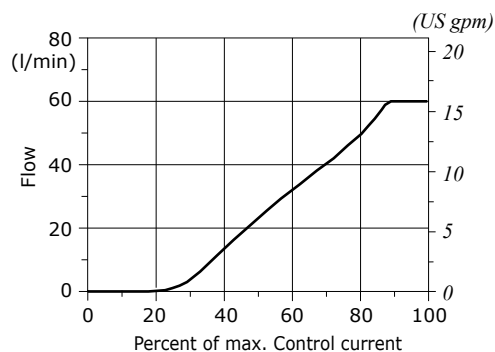

EE12X
**pressure compensation diagram 1→2

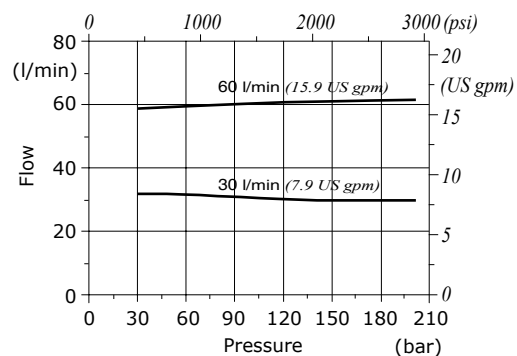

*Compensation diagram were detected with the cartridge combined with a VPR/3/ET 38-12 compensator with 10 bar (145 psi) stand by
 **Compensation diagram were detected with the cartridge combined with a VPR/3/ET 38-12 compensator with 7 bar (102 psi) stand by



EC..T type flow restrictor - 2 way

- Solenoid proportional type
- To be combined with an external compensator
- From SAE08 to SAE16 cavities

Technical specifications and diagrams are measured with mineral oil of 46 cSt viscosity at 40°C (104°F) temperature..

		EC08T	EC10T	EC12T	EC16T
Nominal flow (¹)	with 5 bar (72.5 psi) stand-by	35 l/min (9.2 US gpm)	44 l/min (11.6 US gpm)	55 l/min (15.5 US gpm)	70 l/min (18.5 US gpm)
	with 10 bar (145 psi) stand-by	44 l/min (11.6 US gpm)	58 l/min (15.3 US gpm)	70 l/min (18.5 US gpm)	97 l/min (25.6 US gpm)
Max. pressure		350 bar (5100 psi)			
Oil leakage	at 350 bar (5100 psi)	0.25 cm³/min (0.015 in³/min)	0.25 cm³/min (0.015 in³/min)	0.25 cm³/min (0.015 in³/min)	0.35 cm³/min (0.021 in³/min)
Fluid		mineral based oil			
Viscosity		12-200 cSt			
Max level of contamination		18/16/13 ISO4406			
Fluid temperature	with NBR seals with FPM seals	from -20°C (-4°F) to 80°C (176°F) from -20°C (-4°F) to 100°C (212°F)			
Environmental temp. for working conditions		from -20°C (-4°F) to 50°C (122°F)			
Cavity		SAE 08/2	SAE 10/2	SAE 12/2	SAE 16/2
Coil type (²)		BH			
Nominal voltages		12 VDC - 24 VDC ± 10%			
Power rating		22.8 W (12 VDC) 22.5 W (24 VDC)			
Max control current		12 V -> 1.70 A - 24 V -> 0.85 A (BH)			
Dither frequency		from 100 Hz to 120 Hz			
Weight		0.275 kg (0.61 lb)	0.310 kg (0.68 lb)	0.390 kg (0.86 lb)	0.490 kg (1.08 lb)

NOTE - For different conditions, please contact Walvoil Sales Dpt. - (¹) Values are checked with cartridge in parallel with compensator
(²) For coils further features see from page 206.

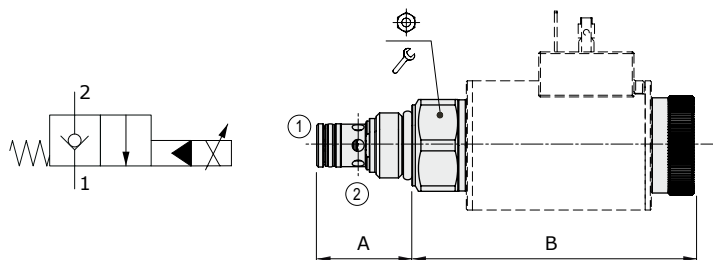

Valve type	A		B		⌀	⌀	Nm	lbft
	mm	in	mm	in				
EC08T	28.1	1.11	83	3.27	27	50	37	
EC10T	32.5	1.28	83	3.27	27	50	37	
EC12T	45	1.77	82.5	3.25	32	85	63	
EC16T	45.6	1.80	81	3.19	32	85	63	

For dimensions with different type of emergency see page 213

Ordering codes and description composition

EC10T/A0NB

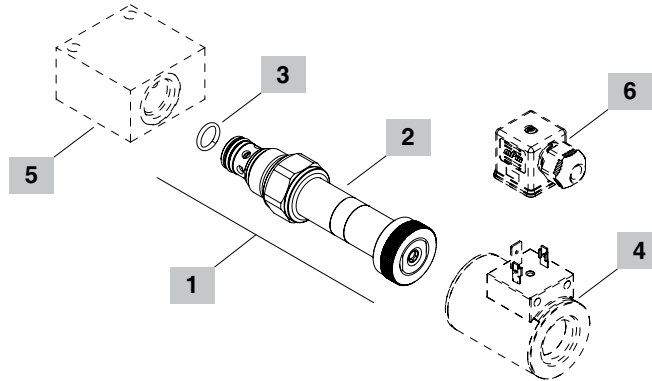
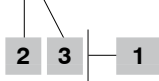

1 Cartucce		
TYPE	CODE	DESCRIPTION
SAE cavity 08/2		
EC08T/A0NB	0EC08002056	Without emergency
EC08T/A0TB	0EC08002058	Screw type emergency
EC08T/A0QB	0EC08002073	"Push&twist" emergency
SAE cavity 10/2		
EC10T/A0NB	0EC10002025	Without emergency
EC10T/A0TB	0EC10002027	Screw type emergency
EC10T/A0QB	0EC10002029	"Push&twist" emergency
SAE cavity 12/2		
EC12T/A0NB	0EC12002018	Without emergency
EC12T/A0TB	0EC12002019	Screw type emergency
EC12T/A0QB	0EC12002020	"Push&twist" emergency
SAE cavity 16/2		
EC16T/A0NB	0EC16002033	Without emergency
EC16T/A0TB	0EC16002035	Screw type emergency
EC16T/A0QB	0EC16002038	"Push&twist" emergency

2 Emergenze	
TYPE	DESCRIPTION
N	Without emergency
T	Screw type emergency
Q	"Push&twist" emergency

3 Seals	
TYPE	DESCRIPTION
B	NBR (Buna) Std configuration without addition
V	For valve with FPM (Viton) o-ring seals, contact Sales Dept.

4 Bobine		
TYPE	CODE	DESCRIPTION
BH 12VDC	4SLD001200	Coil 12VDC-ISO4400
For complete coils list see from page 206		
It is possible also combine coils BQP19		

5 Valve body		
TYPE	CODE	DESCRIPTION
SAE 08/2-SAE8	3CC0820K11	Aluminium body for cavity 08 valve, SAE8 std thread
SAE 10/2-SAE8	3CC1020K11	Aluminium body for cavity 10 valve, SAE8 std thread
SAE 12/2-SAE10	3CC1220L11	Aluminium body for cavity 12 valve, SAE10 std thread
SAE 16/2-SAE12	3CC1620M11	Aluminium body for cavity 16 valve, SAE12 std thread
Note: aluminium body can stand up to 210 bar (3050 psi)		
For steel bodies or different threading see from page 215		

6 Connector		
TYPE	CODE	DESCRIPTION
ISO4400	4CN1009995	Connector
For complete connectors list see from page 206		

Rating diagrams

**EC08T
pressure drop**

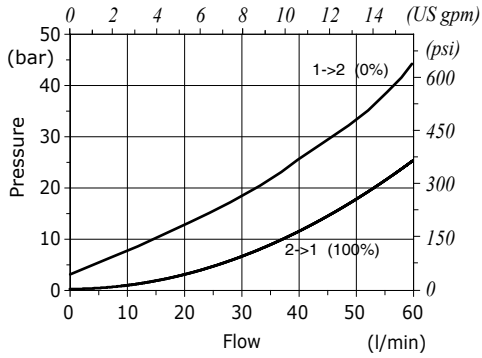

**EC08T
pressure drop**

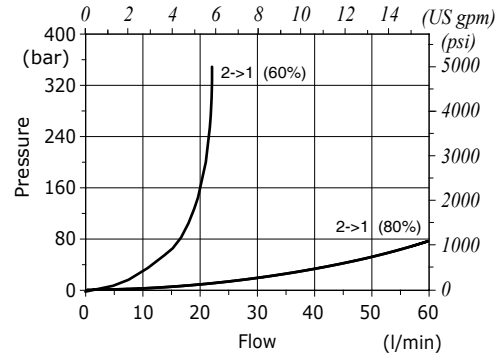

**EC08T
flow regulating vs. % max. control current**

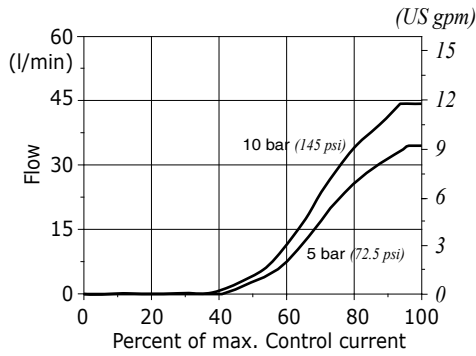

**EC10T
pressure drop**

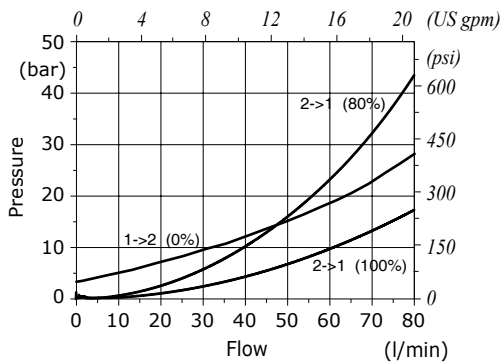

**EC10T
pressure drop**

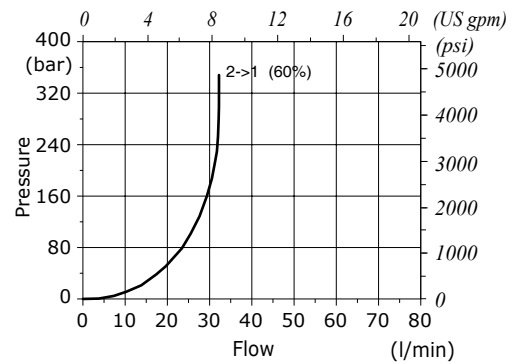

**EC10T
flow regulating vs. % max. control current**

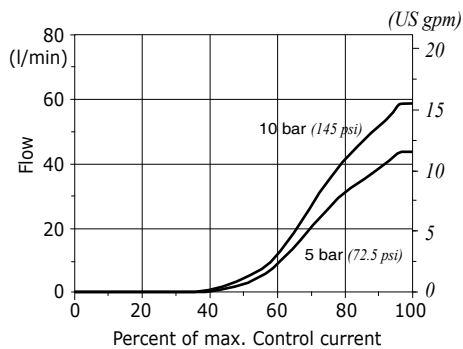

Rating diagrams

**EC12T
pressure drop**

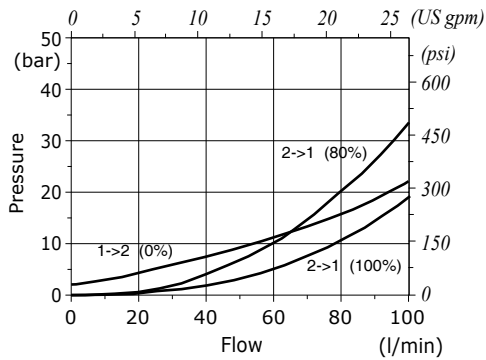

**EC12T
pressure drop**

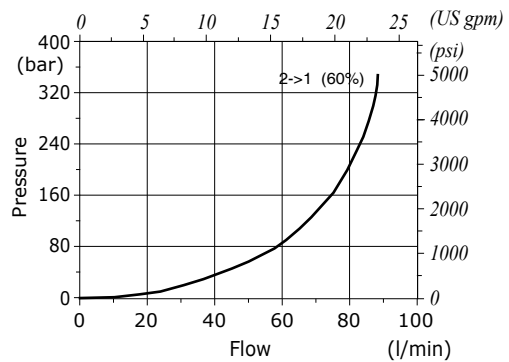

**EC12T
flow regulating vs. % max. control current**

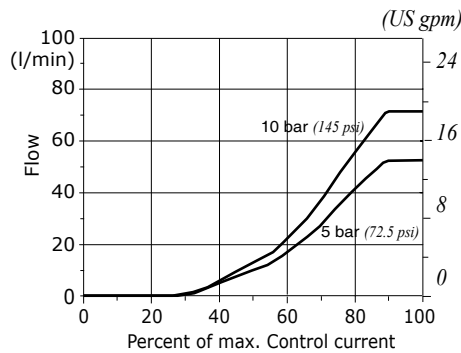

**EC16T
pressure drop**

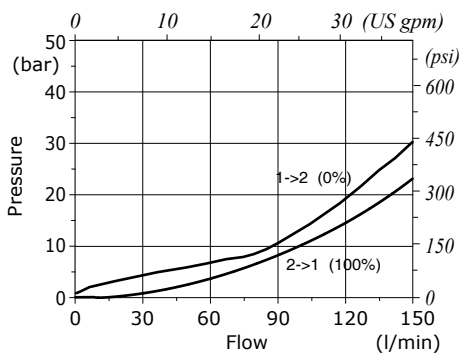

**EC6T
pressure drop**

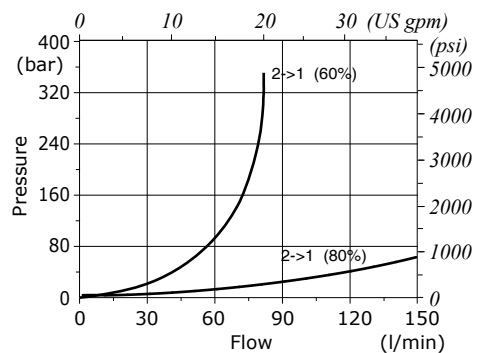

**EC16T
flow regulating vs. % max. control current**

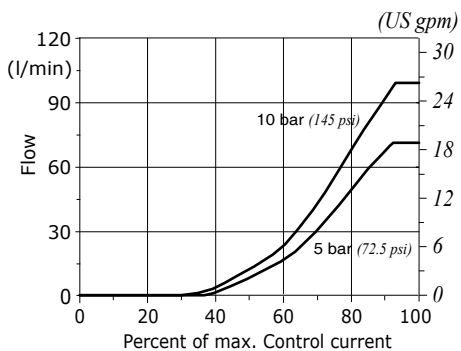



PW..A type flow control pressure compensated valves - 2 way

- With reverse free flow check
- From SAE08 to SAE16 cavities

Technical specifications and diagrams are measured with mineral oil of 46 cSt viscosity at 40°C (104°F) temperature.

	PW08A	PW10A	PW12A	PW16A
Nominal flow	10 l/min (2.6 US gpm)	30 l/min (7.9 US gpm)	50 l/min (13 US gpm)	90 l/min (24 US gpm)
Max. pressure	350 bar (5100 psi)			
Fluid	mineral based oil			
Viscosity	10-200 cSt			
Max level of contamination	20/18/14 ISO4406			
Fluid temperature	with NBR seals with FPM seals	from -20°C (-4°F) to 80°C (176°F) from -20°C (-4°F) to 100°C (212°F)		
Environmental temp. for working conditions	from -20°C (-4°F) to 50°C (122°F)			
Cavity	SAE 08/2 A	SAE 10/2 A	SAE 12/2 A	SAE 16/2 A
Weight	0.22 kg (0.48 lb)	0.30 kg (2.20 lb)	0.72 kg (1.58 lb)	0.98 kg (2.16 lb)

NOTE - For different conditions, please contact Walvoil Sales Dpt.

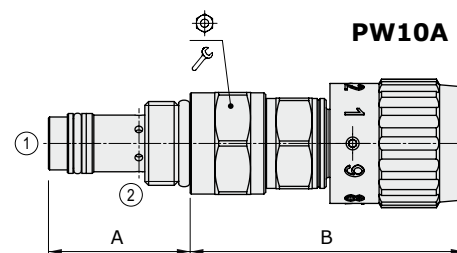
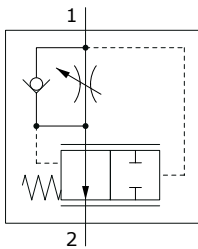

Valve type	A		B		⌀	⌘	Nm	lbft
	mm	in	mm	in				
PW08A/AM	36.6	1.44	64.5	2.54	24	30	22	
PW10A/AM	37.5	1.48	71.9	2.83	27	50	36	
PW12A/AM	58.5	2.30	64.5	2.54	32	80	59	
PW16A/AM	68	2.68	86	3.39	41	100	74	

For dimensions with different type of adjustment see page 212

Ordering codes and description composition

PW08A/AM1B

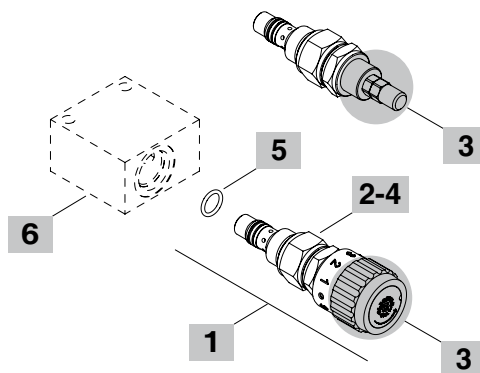
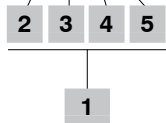

1 Cartridges

TYPE	CODE	DESCRIPTION
SAE cavity 08/2 A		
PW08A/AM1B	0PW08002000	Handknob adjustment
PW08A/AS1B	0PW08002003	Screw type adjustment
SAE cavity 10/2 A		
PW10A/AM1B	0PW10002000	Handknob adjustment
PW10A/AS1B	0PW10002001	Screw type adjustment
SAE cavity 12/2 A		
PW12A/AM1B	0PW12002000	Handknob adjustment
PW12A/AS1B	0PW12002001	Screw type adjustment
SAE cavity 16/2 A		
PW16A/AM1B	0PW16002000	Handknob adjustment
PW16A/AS1B	0PW16002001	Screw type adjustment

2 Pressure drop from 1 to 2

TYPE	DESCRIPTION
A	12 bar (170 psi)

3 Adjustments

TYPE	DESCRIPTION
S	Screw
M	Handknob

4 Pressure drop from 2 to 1

TYPE	DESCRIPTION
1	0.5 bar (7.3 psi)

5 Seals

TYPE	DESCRIPTION
B	NBR (Buna) Std configuration without addition
V	For valve with FPM (Viton) o-ring seals, contact Sales Dept.

6 Valve body

TYPE	CODE	DESCRIPTION
SAE 08/2-SAE8	3CC0820K11	Aluminium body for cavity 08 valve, SAE8 std thread
SAE 10/2-SAE8	3CC1020K11	Aluminium body for cavity 10 valve, SAE8 std thread
SAE 12/2-SAE10	3CC1220L11	Aluminium body for cavity 12 valve, SAE10 std thread
SAE 16/2-SAE12	3CC1620M11	Aluminium body for cavity 16 valve, SAE12 std thread

Note: aluminium body can stand up to 210 bar (3050 psi)
For steel bodies or different threading see from page 215

Rating diagrams

PW08A
pressure compensation diagram 1→2

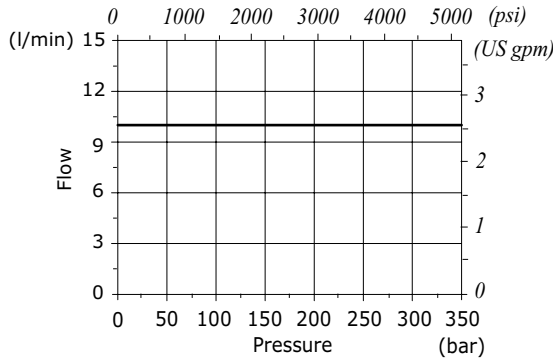

PW08A
pressure drop vs flow 2→1

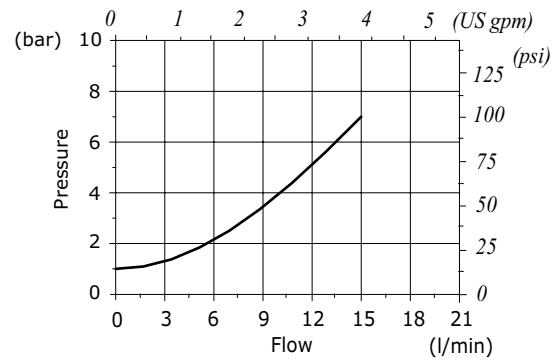

PW10A
pressure compensation diagram 1→2

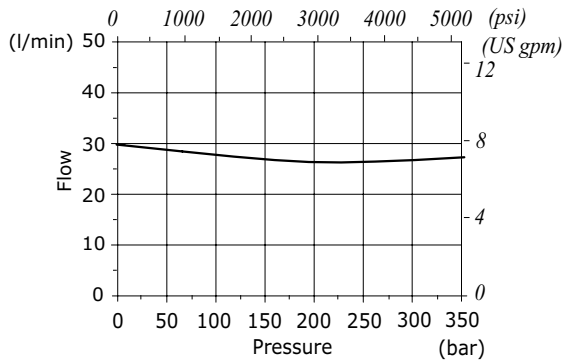

PW10A
pressure drop vs flow 2→1

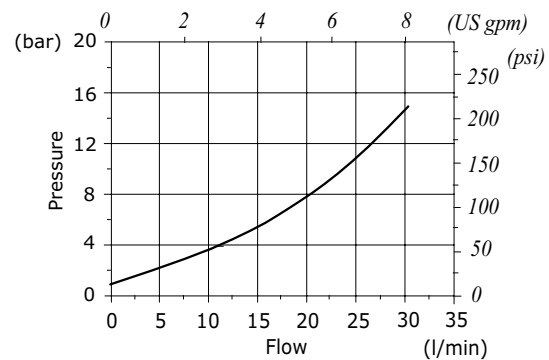

PW12A
pressure compensation diagram 1→2

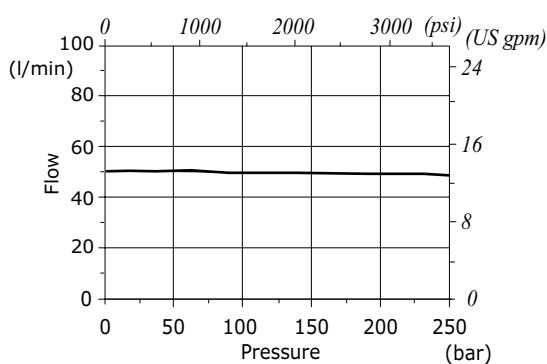

PW12A
pressure drop vs flow 2→1

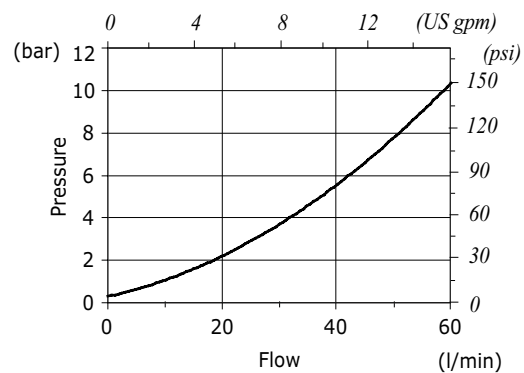

Rating diagrams

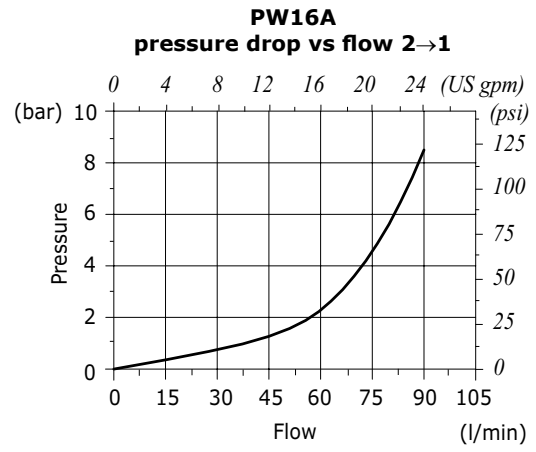
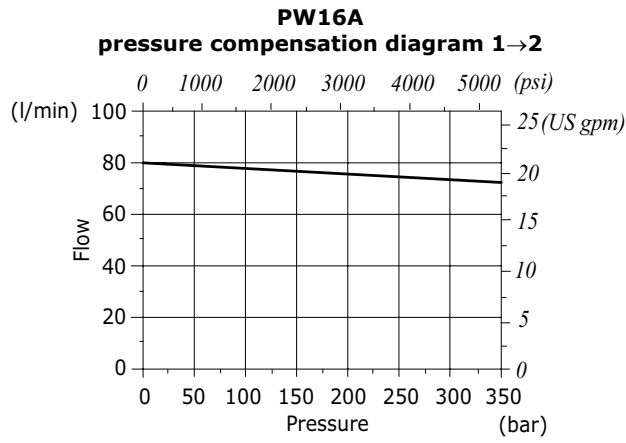



PU..A type flow control pressure compensated valves - 2 way

- Line mounting
- From SAE08 to SAE16 cavities

Technical specifications and diagrams are measured with mineral oil of 46 cSt viscosity at 40°C (104°F) temperature.

	PU08A	PU10A	PU12A	PU16A
Nominal flow	15 l/min (3.9 US gpm)	30 l/min (7.9 US gpm)	50 l/min (13 US gpm)	90 l/min (24 US gpm)
Max. pressure	350 bar (5100 psi)			
Fluid	mineral based oil			
Viscosity	10-200 cSt			
Max level of contamination	20/18/14 ISO4406			
Fluid temperature	with NBR seals with FPM seals	from -20°C (-4°F) to 80°C (176°F) from -20°C (-4°F) to 100°C (212°F)		
Environmental temp. for working conditions	from -20°C (-4°F) to 50°C (122°F)			
Cavity	SAE 08/2 A	SAE 10/2 A	SAE 12/2 A	SAE 16/2 A
Weight	0.18 kg (0.40 lb)	0.20 kg (0.44 lb)	0.30 kg (0.66 lb)	0.55 kg (1.21 lb)

NOTE - For different conditions, please contact Walvoil Sales Dpt.

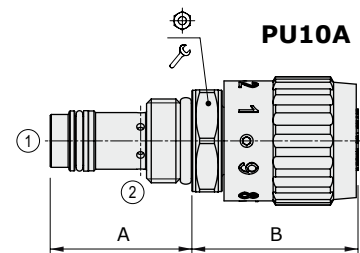
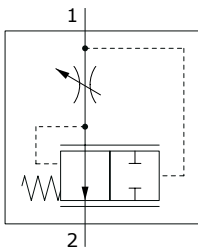

Valve type	A		B		⊕	⌘	Nm	lbft
	mm	in	mm	in				
PU08A/AM	33.6	1.32	48.5	1.91	24	30	22	
PU10A/AM	37.5	1.48	43	1.69	27	50	36	
PU12A/AM	58.5	2.30	44	1.73	32	80	59	
PU16A/AM	68	2.68	52	2.05	41	100	74	

For dimensions with different type of adjustment see page 206

Ordering codes and description composition

PU08A/AM0B

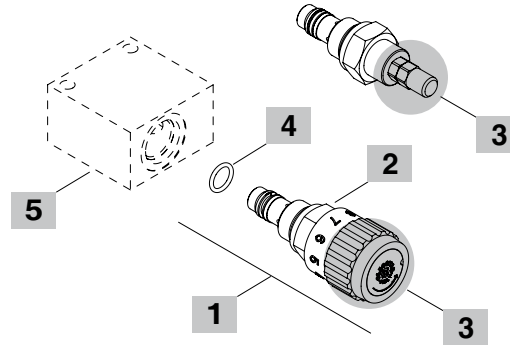
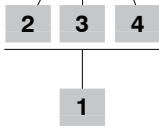

1 Cartridges

TYPE	CODE	DESCRIPTION
SAE cavity 08/2 A		
PU08A/AM0B	0PU08002000	Handknob adjustment
PU08A/AS0B	0PU08002003	Screw type adjustment
SAE cavity 10/2 A		
PU10A/AM0B	0PU10002001	Handknob adjustment
PU10A/AS0B	0PU10002000	Screw type adjustment
SAE cavity 12/2 A		
PU12A/AM0B	0PU12002000	Handknob adjustment
PU12A/AS0B	0PU12002003	Screw type adjustment
SAE cavity 16/2 A		
PU16A/AM0B	0PU16002000	Handknob adjustment
PU16A/AS0B	0PU16002007	Screw type adjustment

2 Pressure drop from 1 to 2

TYPE	DESCRIPTION
A	12 bar (170 psi)

3 Adjustments

TYPE	DESCRIPTION
S	Screw
M	Handknob

4 Seals

TYPE	DESCRIPTION
B	NBR (Buna) Std configuration without addition
V	For valve with FPM (Viton) o-ring seals, contact Sales Dept.

5 Valve body

TYPE	CODE	DESCRIPTION
SAE 08/2-SAE8	3CC0820K11	Aluminium body for cavity 08 valve, SAE8 std thread
SAE 10/2-SAE8	3CC1020K11	Aluminium body for cavity 10 valve, SAE8 std thread
SAE 12/2-SAE10	3CC1220L11	Aluminium body for cavity 12 valve, SAE10 std thread
SAE 16/2-SAE12	3CC1620M11	Aluminium body for cavity 16 valve, SAE12 std thread

Note: aluminium body can stand up to 21.0 bar (3050 psi)
For steel bodies or different threading see from page 215

Rating diagrams

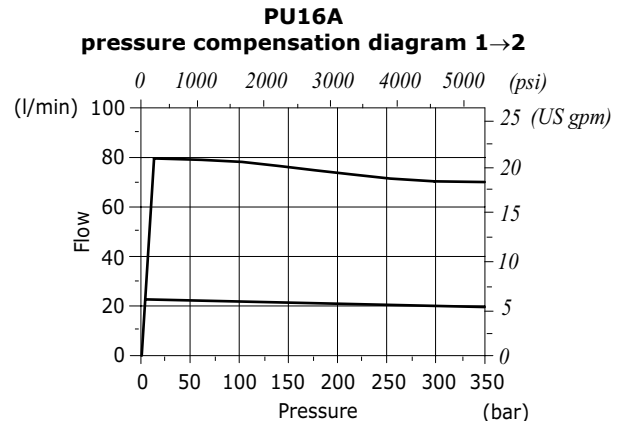
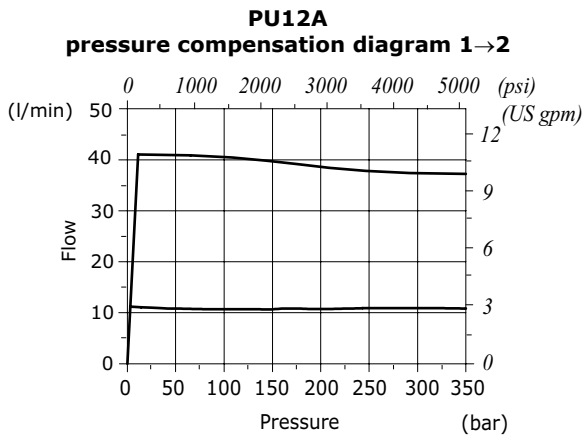
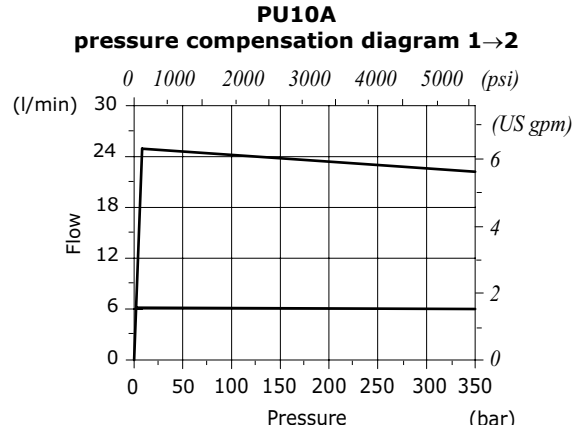
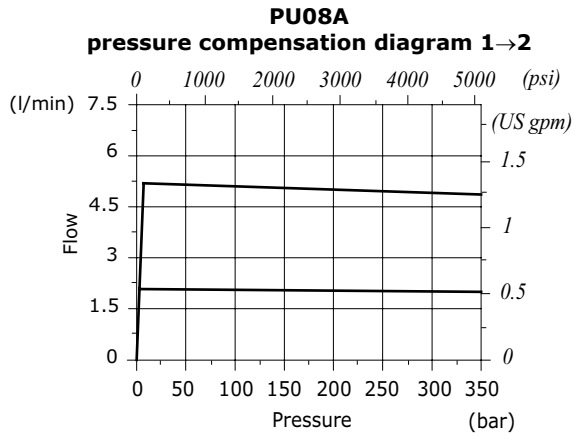



PU..X type flow control pressure compensated valves - 2 way

- Solenoid proportional type
- From SAE08 to SAE16 cavities

Technical specifications and diagrams are measured with mineral oil of 46 cSt viscosity at 40°C (104°F) temperature.

	PU08X	PU10X	PU12X	PU16X	
Nominal flow	10 l/min (2.6 US gpm)	30 l/min (7.9 US gpm)	50 l/min (13.2 US gpm)	90 l/min (23.8 US gpm)	
Max. pressure	315 bar (4600 psi)				
Oil leakage	at 210 bar 3050 psi	80 cm ³ /min (8.9 in ³ /min)	150 cm ³ /min (9.2 in ³ /min)	250 cm ³ /min (15.3 in ³ /min)	400 cm ³ /min (24.4 in ³ /min)
Fluid	mineral based oil				
Viscosity	10-200 cSt				
Max level of contamination	18/16/13 ISO4406				
Fluid temperature	with NBR seals with FPM seals	from -20°C (-4°F) to 80°C (176°F) from -20°C (-4°F) to 100°C (212°F)			
Environmental temp. for working conditions	from -20°C (-4°F) to 50°C (122°F)				
Cavity	SAE 08/2 A	SAE 10/2 A	SAE 12/2 A	SAE 16/2 A	
Coil type*	BH or BQP19				
Nominal voltages	12 VDC - 24V DC ± 10%				
Power rating	20.4 W (BH) - 15 W (BQP19)				
Max control current	12 V -> 1.70 A - 24 V -> 0.85 A (BH) 12 V -> 1.25 A - 24 V -> 0.63 A (BQP19)				
Dither frequency	150 Hz				
Hysteresis	8%				
Weight	0.34 kg (0.75 lb)	0.39 kg (0.86 lb)	0.51 kg (1.12 lb)	0.90 kg (1.98 lb)	

NOTE - For different conditions, please contact Walvoil Sales Dpt. - For coils further features see from page 206.

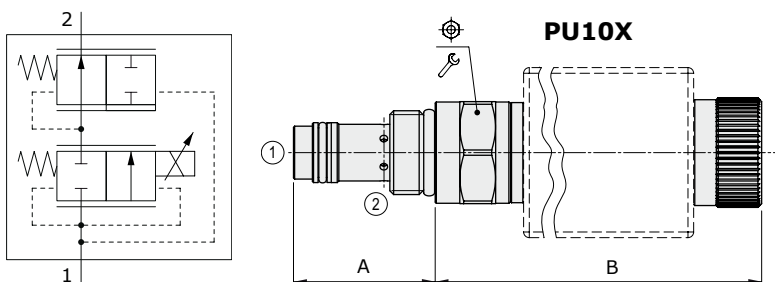

Valve type	A		B		⊕	⌘	Nm	lbft
	mm	in	mm	in				
PU08X/A0N	36.6	1.44	94	3.70	24	30	22	
PU10X/A0N	37.5	1.48	96.4	3.79	27	50	37	
PU12X/A0N	58.5	2.30	97.4	3.83	32	75	55	
PU16X/A0N	68	2.68	121.4	4.78	41	95	70	

For dimensions with different type of emergency see page 213

Ordering codes and description composition

PU08X/A0NB

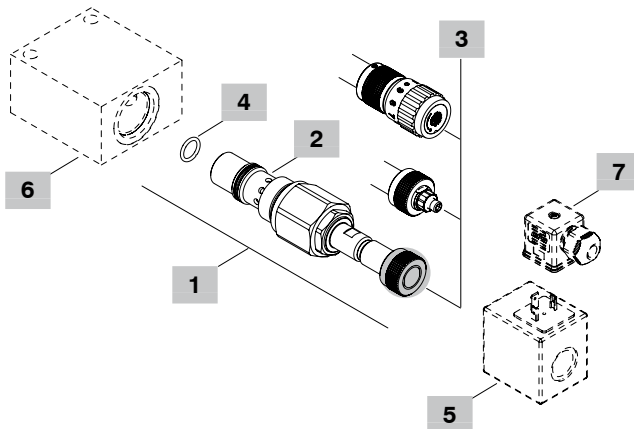
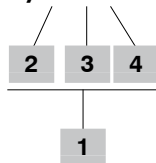

1 Cartridges

TYPE	CODE	DESCRIPTION
SAE cavity 08/2 A		
PU08X/A0NB	0PU08002012	Without emergency
PU08X/A0TB	0PU08002013	Screw type emergency
PU08X/A0VB	0PU08002014	Handknob emergency
SAE cavity 10/2 A		
PU10X/A0NB	0PU10002020	Without emergency
PU10X/A0TB	0PU10002021	Screw type emergency
PU10X/A0VB	0PU10002022	Handknob emergency
SAE cavity 12/2 A		
PU12X/A0NB	0PU12002007	Without emergency
PU12X/A0TB	0PU12002008	Screw type emergency
PU12X/A0VB	0PU12002009	Handknob emergency
SAE cavity 16/2 A		
PU16X/A0NB	0PU16002010	Without emergency
PU16X/A0TB	0PU16002011	Screw type emergency
PU16X/A0VB	0PU16002012	Handknob emergency

2 Pressure drop from 1 to 2

TYPE	DESCRIPTION
A	12 bar (170 psi)

3 Emergency

TYPE	DESCRIPTION
N	Without emergency
T	Screw type
V	Handknob

4 Seals

TYPE	DESCRIPTION
B	NBR (Buna) Std configuration without addition
V	For valve with FPM (Viton) o-ring seals, contact Sales Dept.

5 Coils

TYPE	CODE	DESCRIPTION
BQP19 12VDC	4SL5000126	12VDC-ISO4400 coil
BH 12VDC	4SLD001200	12VDC-ISO4400 coil

For complete coils list see from page 206

6 Valve body

TYPE	CODE	DESCRIPTION
SAE 08/2-SAE8	3CC0820K11	Aluminium body for cavity 08 valve, SAE8 std thread
SAE 10/2-SAE8	3CC1020K11	Aluminium body for cavity 10 valve, SAE8 std thread
SAE 12/2-SAE10	3CC1220L11	Aluminium body for cavity 12 valve, SAE10 std thread
SAE 16/2-SAE12	3CC1620M11	Aluminium body for cavity 16 valve, SAE12 std thread

Note: aluminium body can stand up to 210 bar (3050 psi)
For steel bodies or different threading see from page 215

7 Connector

TYPE	CODE	DESCRIPTION
ISO4400	4CN1009995	Connector

For complete connectors list see from page 206

Rating diagrams

PU08X: pressure compensation diagram 1→2
for % of control current

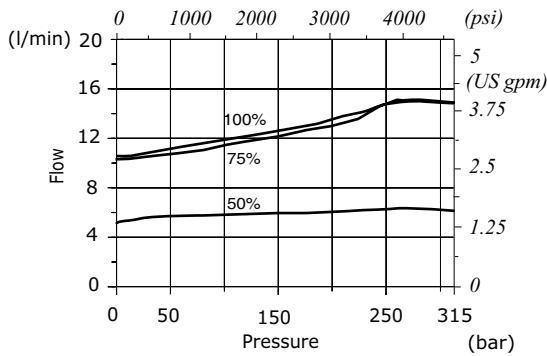

PU08X
flow regulating vs. % max. control current

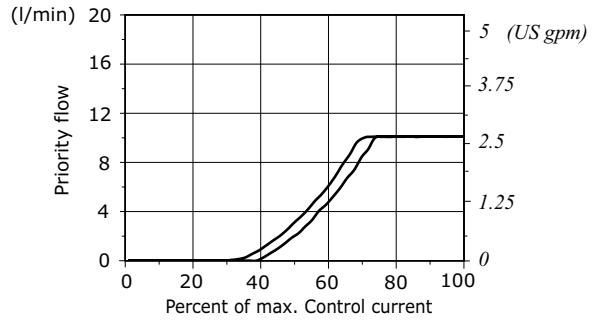

PU10X: pressure compensation diagram 1→2
for % of control current

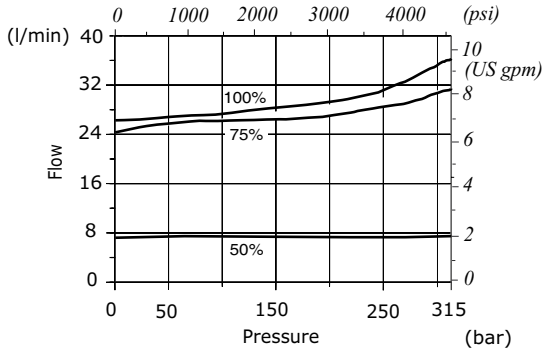

PU10X
flow regulating vs. % max. control current

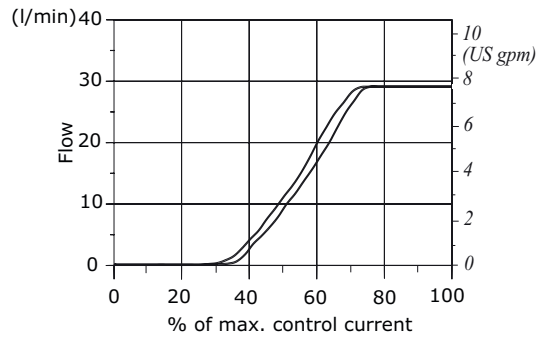

PU12X: pressure compensation diagram 1→2
for % of control current

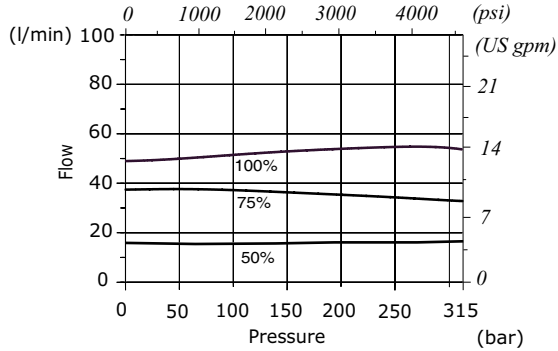

PU12X
flow regulating vs. % max. control current

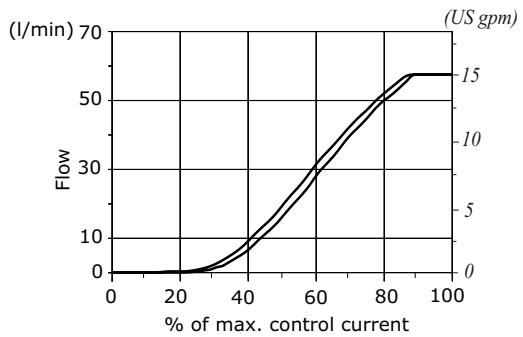

PU16X: pressure compensation diagram 1→2
for % of control current

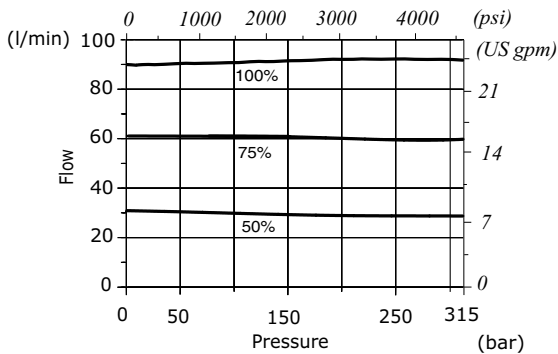

PU16X
flow regulating vs. % max. control current

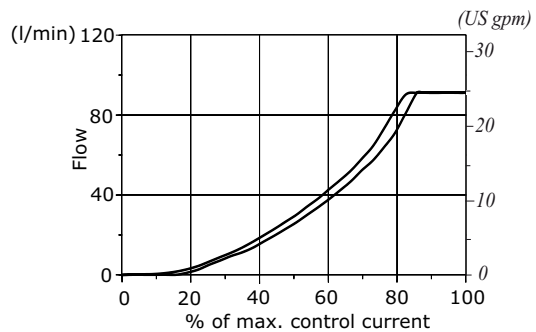



PP..A type flow control pressure compensated valves - 3 way

- With exceeding flow to pressure
- From SAE08 to SAE16 cavities

Technical specifications and diagrams are measured with mineral oil of 46 cSt viscosity at 40°C (104°F) temperature.

	PP08A	PP10A	PP12A	PP16A	
Nominal flow	Q1max=	20 l/min (5.2 US gpm)	50 l/min (13.2 US gpm)	90 l/min (23.8 US gpm)	150 l/min (39.6 US gpm)
	Q3max=	15 l/min (4 US gpm)	30 l/min (7.9 US gpm)	50 l/min (13 US gpm)	90 l/min (24 US gpm)
Max. pressure	350 bar (5100 psi)				
Fluid	mineral based oil				
Viscosity	10-200 cSt				
Max level of contamination	20/18/14 ISO4406				
Fluid temperature	with NBR seals	from -20°C (-4°F) to 80°C (176°F)			
	with FPM seals	from -20°C (-4°F) to 100°C (212°F)			
Environmental temp. for working conditions	from -20°C (-4°F) to 50°C (122°F)				
Cavity	SAE 08/3	SAE 10/3	SAE 12/3	SAE 16/3	
Weight	0.15 kg (0.33 lb)	0.20 kg (0.44 lb)	0.42 kg (0.92 lb)	0.57 kg (1.26 lb)	

NOTE - For different conditions, please contact Walvoil Sales Dpt.

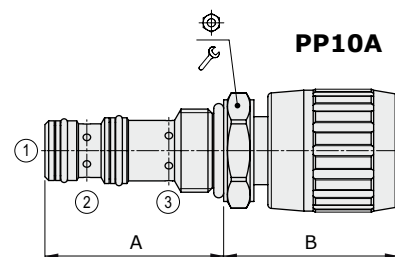
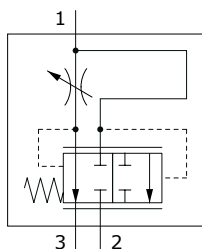

Valve type	A		B		⊕	🔧	Nm	lbft
	mm	in	mm	in				
PP08A/AM	41.1	1.62	49.5	1.95	24	30	22	
PP10A/AM	47.2	1.86	44	1.73	27	50	37	
PP12A/AM	73.5	2.89	45	1.77	32	80	59	
PP16A/AM	75	2.95	52	1.93	41	100	74	

For dimensions with different type of adjustment see page 212

Ordering codes and description composition

PP08A/AM0B

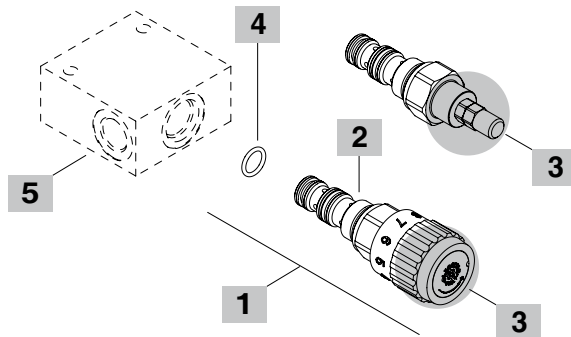
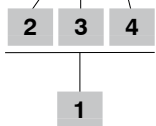

1 Cartridges

TYPE	CODE	DESCRIPTION
SAE cavity 08/3		
PP08A/AM0B	OPP08002000	Handknob adjustment
PP08A/AS0B	OPP08002004	Screw type adjustment
SAE cavity 10/3		
PP10A/AM0B	OPP10002000	Handknob adjustment
PP10A/AS0B	OPP10002005	Screw type adjustment
SAE cavity 12/3		
PP12A/AM0B	OPP12002000	Handknob adjustment
PP12A/AS0B	OPP12002004	Screw type adjustment
SAE cavity 16/3		
PP16A/AM0B	OPP16002001	Handknob adjustment
PP16A/AS0B	OPP16002006	Screw type adjustment

2 Pressure drop from 1 to 2

TYPE	DESCRIPTION
A	12 bar (170 psi)

3 Adjustments

TYPE	DESCRIPTION
S	Screw
M	Handknob

4 Seals

TYPE	DESCRIPTION
B	NBR (Buna) Std configuration without addition
V	For valve with FPM (Viton) o-ring seals, contact Sales Dept.

5 Valve body

TYPE	CODE	DESCRIPTION
SAE 08/3-SAE8	3CC0830K11	Aluminium body for cavity 08 valve, SAE8 std thread
SAE 10/3-SAE8	3CC1030K11	Aluminium body for cavity 10 valve, SAE8 std thread
SAE 12/3-SAE10	3CC1230L11	Aluminium body for cavity 12 valve, SAE10 std thread
SAE 16/3-SAE12	3CC1630M11	Aluminium body for cavity 16 valve, SAE12 std thread

Note: aluminium body can stand up to 210 bar (3050 psi)
For steel bodies or different threading see from page 217

Rating diagrams

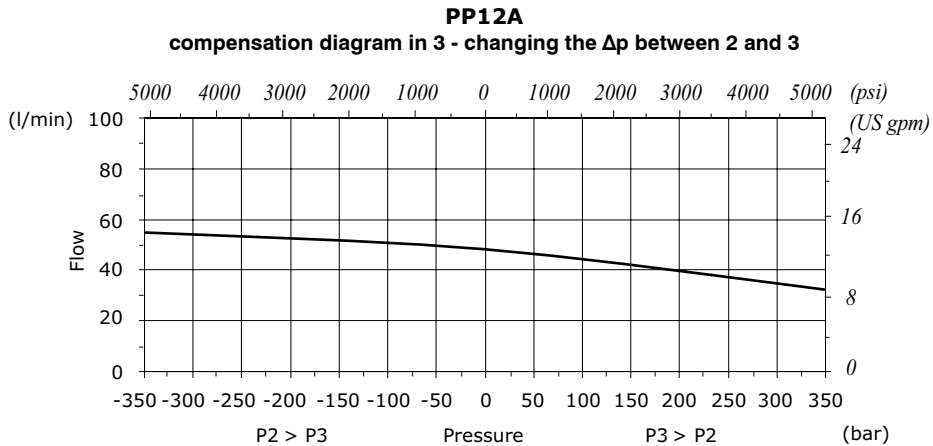
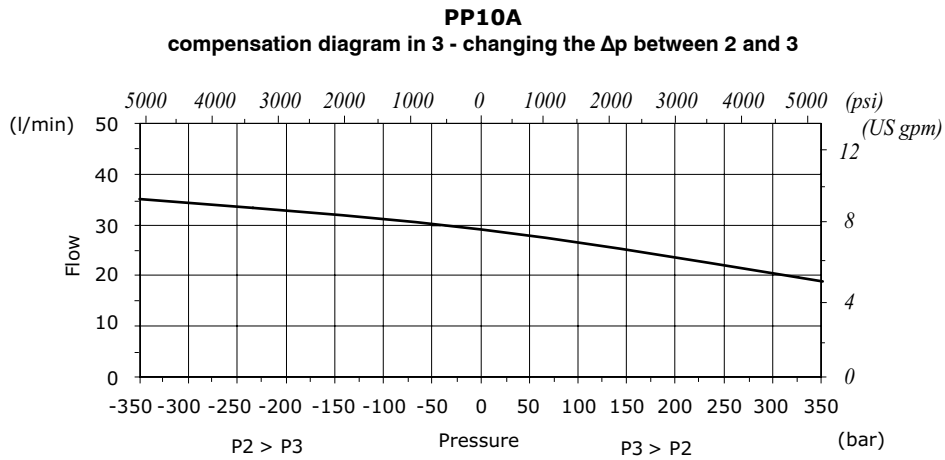
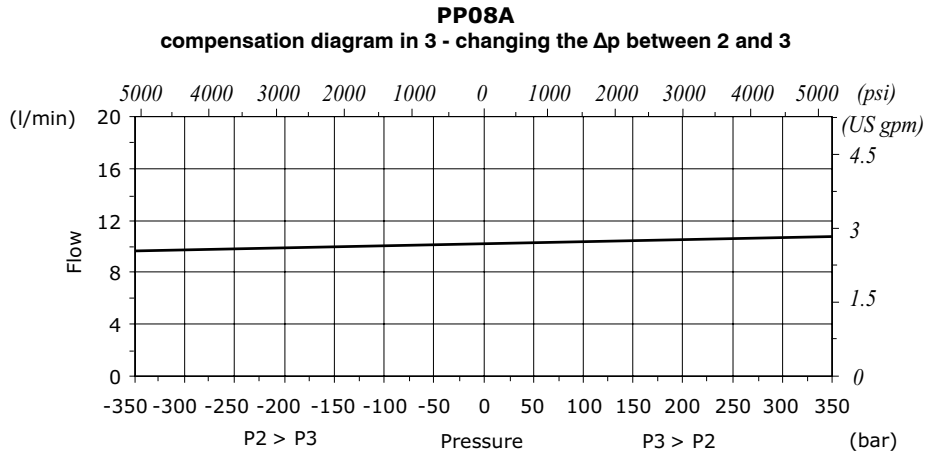

Rating diagrams

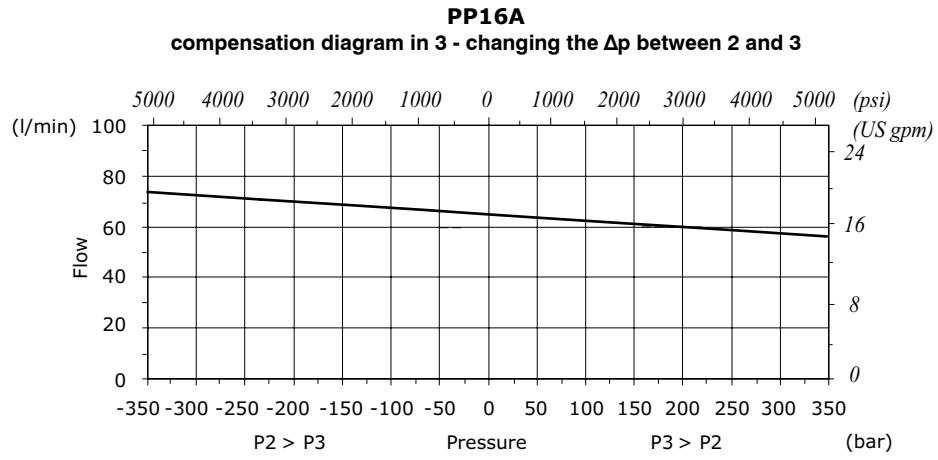



PP..X type flow control pressure compensated valves - 3 way

- Solenoid proportional type
- With exceeding flow to pressure
- From SAE08 to SAE16 cavities

Technical specifications and diagrams are measured with mineral oil of 46 cSt viscosity at 40°C (104°F) temperature.

	PP08X	PP10X	PP12X	PP16X	
Nominal flow	Q1max= 20 l/min (5.2 US gpm) Q3max= 15 l/min (3.9 US gpm)	50 l/min (13.2 US gpm) 30 l/min (8 US gpm)	90 l/min (23.8 US gpm) 60 l/min (16 US gpm)	150 l/min (39.6 US gpm) 90 l/min (23.8 US gpm)	
Max. pressure	315 bar (4560 psi)				
Oil leakage	at 210 bar (3050 psi)	80 cm ³ /min (4.9 in ³ /min)	150 cm ³ /min (9.2 in ³ /min)	250 cm ³ /min (15.3 in ³ /min)	400 cm ³ /min (24.4 in ³ /min)
Fluid	mineral based oil				
Viscosity	10-200 cSt				
Max level of contamination	18/16/13 ISO4406				
Fluid temperature	with NBR seals with FPM seals	from -20°C (-4°F) to 80°C (176°F) from -20°C (-4°F) to 100°C (212°F)			
Environmental temp. for working conditions	from -20°C (-4°F) to 50°C (122°F)				
Cavity	SAE 08/3	SAE 10/3	SAE 12/3	SAE 16/3	
Coil type*	BQP19 or BH				
Nominal voltages	12 VDC - 24 VDC ± 10%				
Power rating	20.4 W (BH) - 15 W (BQP19)				
Max control current	12 V -> 1.70 A - 24 V -> 0.85 A (BH) 12 V -> 1.25 A - 24 V -> 0.63 A (BQP19)				
Dither frequency	150 Hz				
Hysteresis	8%				
Weight	0.44 kg (0.97 lb)	0.49 kg (1.08 lb)	0.61 kg (1.34 lb)	1 kg (2.20 lb)	

NOTE - For different conditions, please contact Walvoil Sales Dpt. - For coils further features see from page 206.

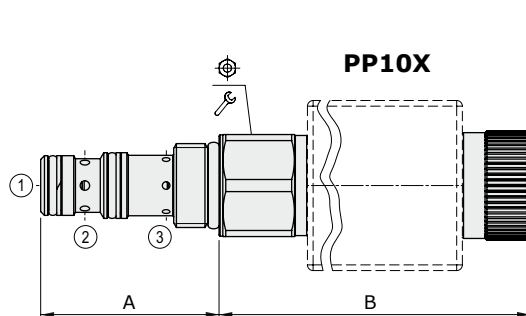
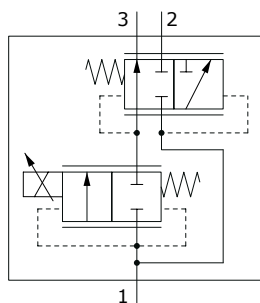

Valve type	A		B		Nm	lbft
	mm	in	mm	in		
PP08X/A0N	40.8	1.60	94	3.70	24	30
PP10X/A0N	47.2	1.86	96.4	3.79	27	50
PP12X/A0N	73.5	2.89	97.4	3.83	32	75
PP16X/A0N	75.1	2.95	121.4	4.78	41	95

For dimensions with different type of emergency see page 213

Ordering codes and description composition

PP08X/A0NB

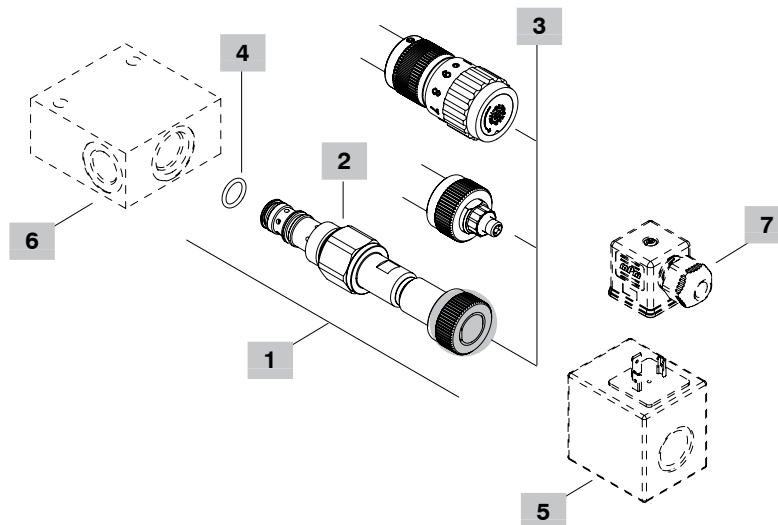
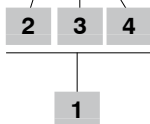

1 Cartridges

TYPE	CODE	DESCRIPTION
SAE cavity 08/3		
PP08X/A0NB	0PP08002014	Without emergency
PP08X/A0TB	0PP08002015	Screw type emergency
PP08X/A0VB	0PP08002016	Handknob emergency
SAE cavity 10/3		
PP10X/A0NB	0PP10002031	Without emergency
PP10X/A0TB	0PP10002033	Screw type emergency
PP10X/A0VB	0PP10002035	Handknob emergency
SAE cavity 12/3		
PP12X/A0NB	0PP12002037	Without emergency
PP12X/A0TB	0PP12002039	Screw type emergency
PP12X/A0VB	0PP12002041	Handknob emergency
SAE cavity 16/3		
PP16X/A0NB	0PP16002013	Without emergency
PP16X/A0TB	0PP16002015	Screw type emergency
PP16X/A0VB	0PP16002014	Handknob emergency

2 Pressure drop from 1 to 3

TYPE	DESCRIPTION
A	12 bar (170 psi)

3 Emergency

TYPE	DESCRIPTION
N	Without emergency
T	Screw type
V	Handknob

4 Seals

TYPE	DESCRIPTION
B	NBR (Buna) Std configuration without addition
V	For valve with FPM (Viton) o-ring seals, contact Sales Dept.

5 Coils

TYPE	CODE	DESCRIPTION
BQP19 12VDC	4SL5000126	12VDC-ISO4400 coil
BH 12VDC	4SLD001200	12VDC-ISO4400 coil

For complete coils list see from page 206

6 Valve body

TYPE	CODE	DESCRIPTION
SAE 08/3-SAE8	3CC0830K11	Aluminium body for cavity 08 valve, SAE8 std thread
SAE 10/3-SAE8	3CC1030K11	Aluminium body for cavity 10 valve, SAE8 std thread
SAE 12/3-SAE10	3CC1230L11	Aluminium body for cavity 12 valve, SAE10 std thread
SAE 16/3-SAE12	3CC1630M11	Aluminium body for cavity 16 valve, SAE12 std thread

Note: aluminium body can stand up to 210 bar (3050 psi)
For steel bodies or different threading see from page 217

7 Connector

TYPE	CODE	DESCRIPTION
ISO4400	4CN1009995	Connector

For complete connectors list see from page 206

Rating diagrams

PP08X
flow regulating vs. % max. control current
 Q_{in} = priority flow + 30%

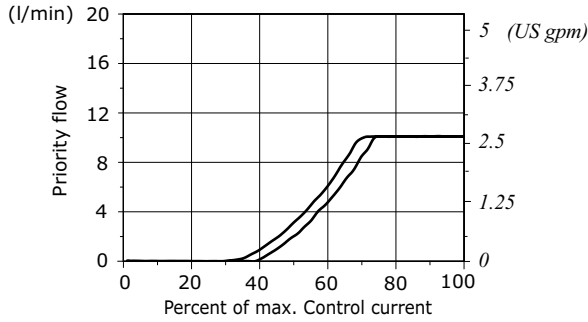

PP08X
pressure compensation diagram 2→3
 for % of control current

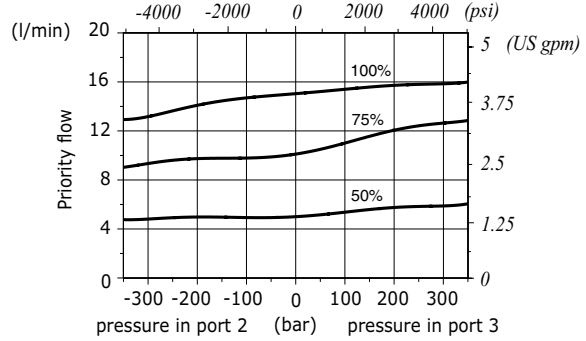

PP08X
pressure drop with de-energized coil
 from 1→2

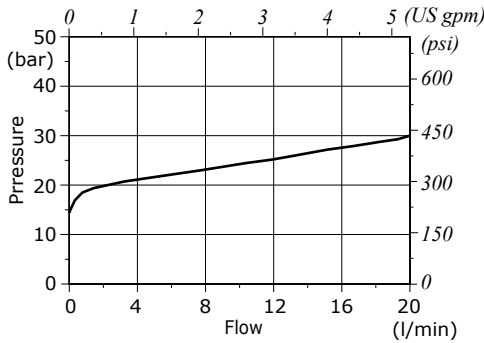

PP10X
flow regulating vs. % max. control current
 Q_{in} = priority flow + 5%

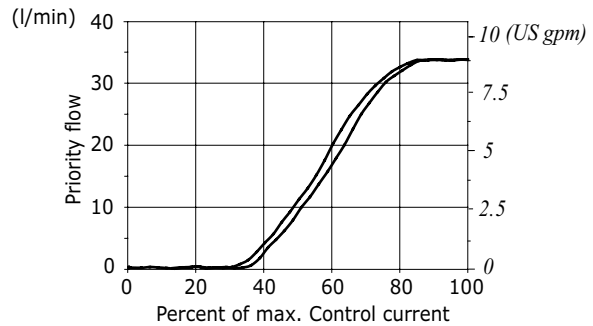

PP10X
pressure compensation diagram 2→3
 for % of control current

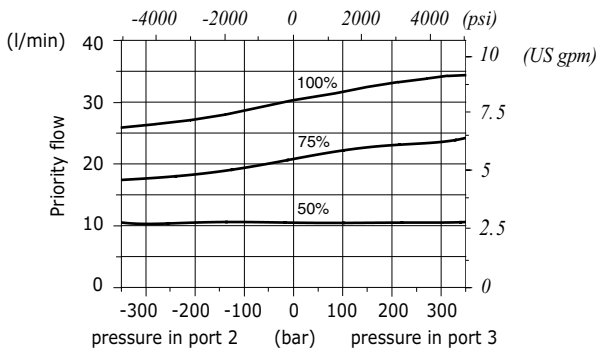

PP10X
pressure drop with de-energized coil
 from 1→2

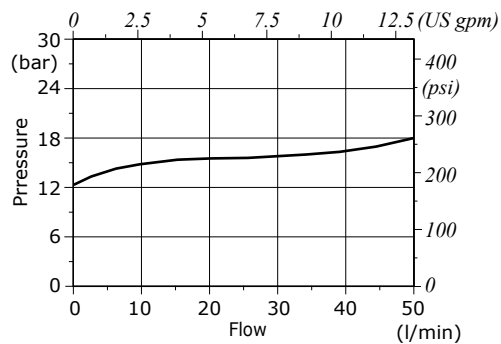

Rating diagrams

PP12X
flow regulating vs. % max. control current
 $Q_{in} = \text{priority flow} + 15\%$

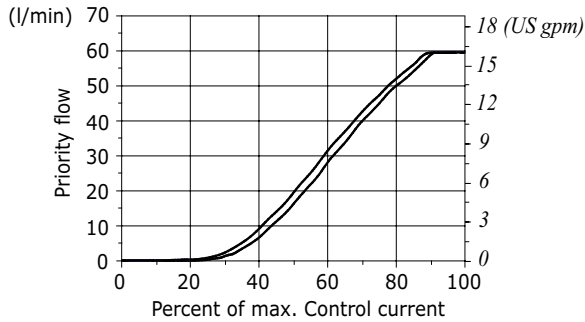

PP12X
pressure compensation diagram 2→3
for % of control current

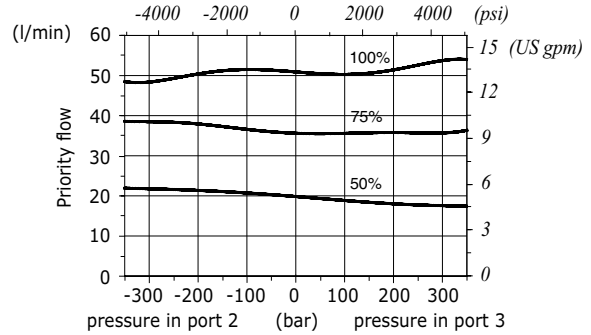

PP12X
pessure drop with de-energized coil
from 1->2

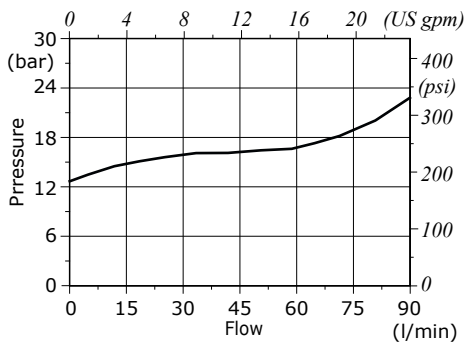

PP16X
flow regulating vs. % max. control current
 $Q_{in} = \text{priority flow} + 10\%$

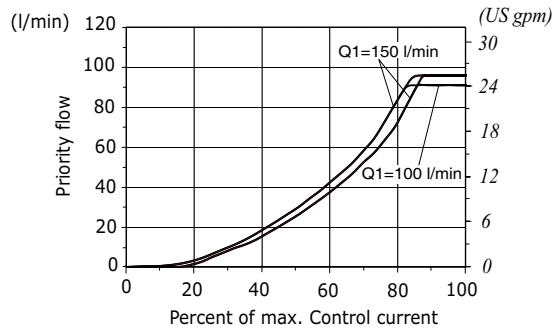

PP16X
pressure compensation diagram 2→3
for % of control current - $Q_1 = 100 \text{ l/min}$

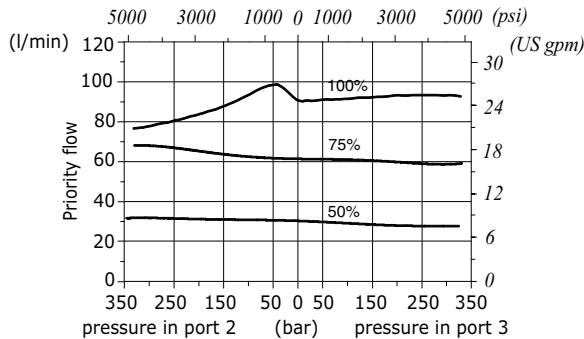

PP16X
pessure drop with de-energized coil
from 1->2

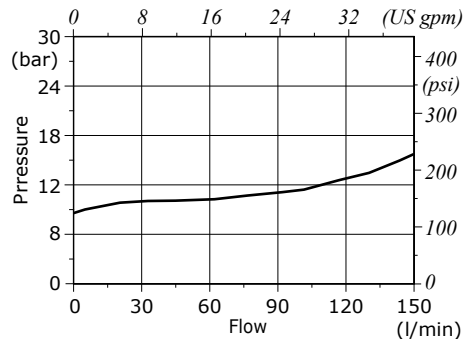



PD... type flow control pressure compensated valves - 3 way

- Flow divider-combiners
- From SAE10 to SAE16 cavities

Technical specifications and diagrams are measured with mineral oil of 46 cSt viscosity at 40°C (104°F) temperature.

	PD10B/110B	PD10B/120B	PD10B/130B	PD10B/140B	PD10B/150B	PD12B/100B	PD16C/110B
Flow range	4-12 l/min (1-3 US gpm)	12-20 l/min (3-5 US gpm)	20-28 l/min (5-7 US gpm)	28-36 l/min (7-9 US gpm)	36-44 l/min (9-12 US gpm)	40-75 l/min (10-20 US gpm)	75-150 l/min (20-40 US gpm)
Max. pressure	210 bar (3045 psi)						
Maximum division error	± 5% of the oil flow in 1 or 3 and 120 bar -1750 psi- pressure difference between 1 and 3. (Division rate 50%÷50%)						
Fluid	mineral based oil						
Viscosity	10-200 cSt						
Max level of contamination	20/18/14 ISO4406						
Fluid temperature	with NBR seals with FPM seals		from -20°C (-4°F) to 80°C (176°F) from -20°C (-4°F) to 100°C (212°F)				
Environmental temp. for working conditions	from -20°C (-4°F) to 50°C (122°F)						
Cavity	SAE 10/4	SAE 10/4	SAE 10/4	SAE 10/4	SAE 10/4	SAE 12/4	SAE 16/4
Weight	0.20 kg (0.44 lb)	0.20 kg (0.44 lb)	0.20 kg (0.44 lb)	0.20 kg (0.44 lb)	0.20 kg (0.44 lb)	0.30 kg (0.66 lb)	0.55 kg (1.21 lb)

NOTE - For different conditions, please contact Walvoil Sales Dpt.

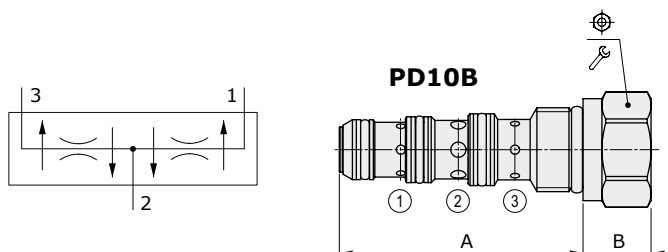

Valve type	A		B		N	T	
	mm	in	mm	in		Nm	lbft
PD10B	64.5	2.54	18	0.71	27	50	37
PD12B	83	3.27	12	0.47	32	80	59
PD16C	104	4.09	17	0.69	41	100	74

Ordering codes and description composition

PD10B/110B

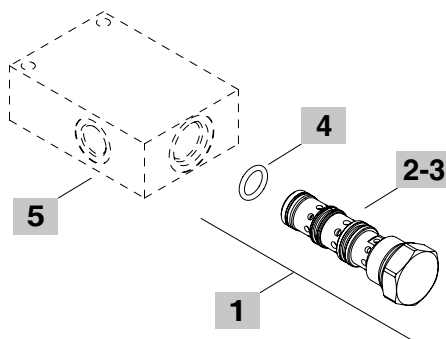
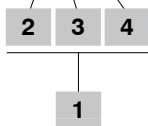

4 Cartridges

TYPE CODE DESCRIPTION

SAE cavity 10/4

- PD10B/110B 0PD10002004 Flow range 1
- PD10B/120B 0PD10002005 Flow range 2
- PD10B/130B 0PD10002006 Flow range 3
- PD10B/140B 0PD10002007 Flow range 4
- PD10B/150B 0PD10002008 Flow range 5

SAE cavity 12/4

PD12B/100B 0PD12002001 Range 40÷75 l/min (10-20 US gpm)

SAE cavity 16/4

PD16C/100B 0PD16002003 Range 75÷150 l/min (20-40 US gpm)

3 Seals

TYPE DESCRIPTION

- B** NBR (Buna) Std configuration without addition
- V** For valve with FPM (Viton) o-ring seals, contact Sales Dept.

6 Valve body

TYPE CODE DESCRIPTION

- SAE 10/4-SAE8** 3CC1040K11 Aluminium body for cavity 10 valve, SAE8 std thread
- SAE 12/4-SAE10** 3CC1240L11 Aluminium body for cavity 12 valve, SAE10 std thread
- SAE 16/4-SAE16** 3CC1640N11 Aluminium body for cavity 16 valve, SAE16 std thread

Note: aluminium body can stand up to 210 bar (3050 psi)
For steel bodies or different threading see from page 219

1 Dividing-Combining ratio

TYPE DESCRIPTION

- 1** 50÷50

2 Flow range

TYPE DESCRIPTION

- 1** 4÷12 l/min (1-3 US gpm)
- 2** 12÷20 l/min (3-5 US gpm)
- 3** 20÷28 l/min (5-7 US gpm)
- 4** 28÷36 l/min (7-9 US gpm)
- 5** 36÷44 l/min (9-12 US gpm)

Rating diagrams

PD10B
pressure drop vs flow
from 2->1/3 and from 1/3->2

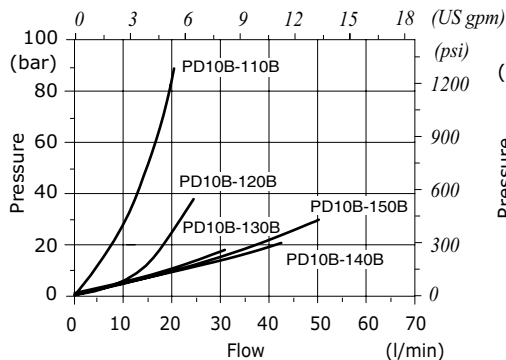

PD12B
pressure drop vs flow
from 2->1/3 and from 1/3->2

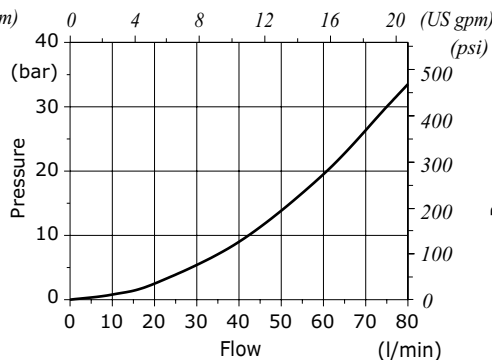

PD16C
pressure drop vs flow
from 2->1/3 and from 1/3->2

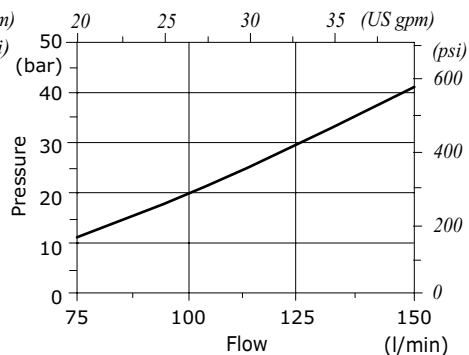



LA..QA type logic element - 3 way

- Pilot to close configuration
- Fixed or adjustable Stand-by
- SAE10 and SAE16 cavities

Technical specifications and diagrams are measured with mineral oil of 46 cSt viscosity at 40°C (104°F) temperature.

	LA10QA	LA16QA
Nominal flow	80 l/min (21 US gpm)	190 l/min (50 US gpm)
Max. pressure	350 bar (5100 psi)	
Opening pressure	fixed setting: 1, 5, 10 bar (14.5, 72.5, 145 psi) adjustable setting: from 8 to 15 bar (116 to 218 psi)	
Oil leakage at 210 bar (3050 psi)	80 cm ³ /min (4.88 in ³ /min)	230 cm ³ /min (14.03 in ³ /min)
Fluid	mineral based oil	
Viscosity	10-200 cSt	
Max level of contamination	20/18/14 ISO4406	
Fluid temperature	with NBR seals with FPM seals	from -20°C (-4°F) to 80°C (176°F) from -20°C (-4°F) to 100°C (212°F)
Environmental temp. for working conditions	from -20°C (-4°F) to 50°C (122°F)	
Cavity	SAE 10/3Q	SAE 16/3Q
Weight	0.15 kg (0.33 lb)	0.45 kg (0.99 lb)

NOTE - For different conditions, please contact Walvoil Sales Dpt.

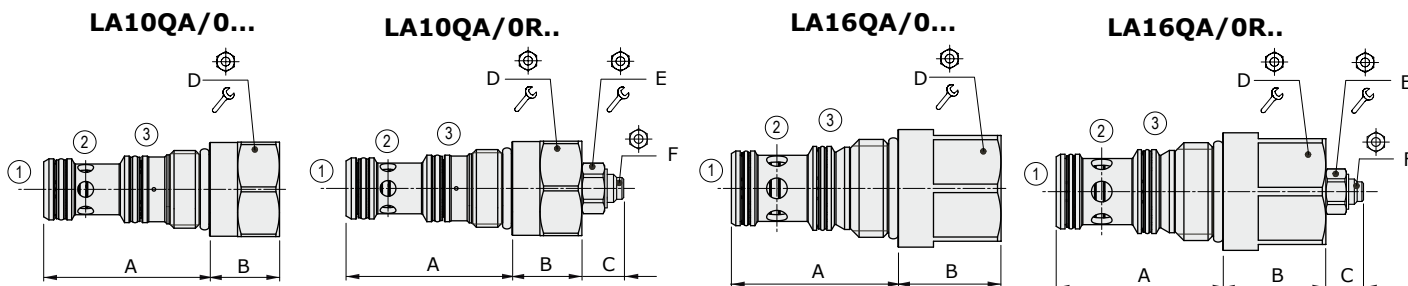
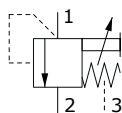

Valve type	A		B		C (max)		D		E		F		
	mm	in	mm	in	mm	in	Nm	lbft	Nm	lbft	mm		
LA10QA	47.6	1.87	20	0.79	21	0.83	27	70	52	13	9.8	7.2	3
LA16QA	56.9	2.24	35.1	1.38	24	0.94	36	100	74	13	9.8	7.2	3

Ordering codes and description composition

LA 10QA/0 C 0 B SB=12bar

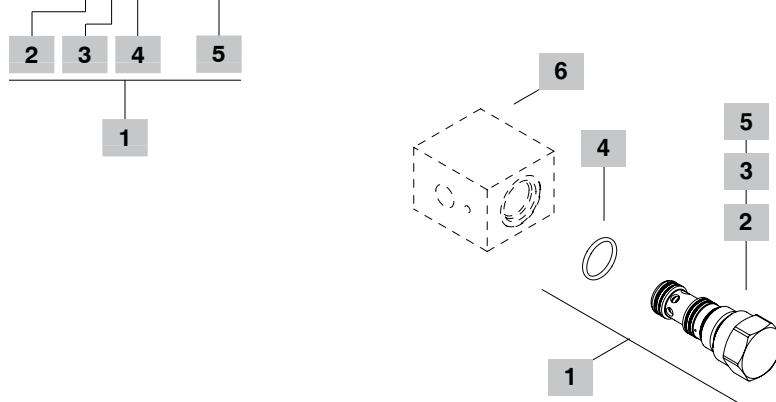

1 Cartridge		
TYPE	CODE	DESCRIPTION
SAE cavity 10/3Q		
LA10QA/0B0B	0LA10Q002003	Fixed setting, 5 bar (72.5 psi)
LA10QA/0C0B	0LA10Q002001	Fixed setting, 10 bar (145 psi)
LA10QA/0R0B SB=12bar	0LA10Q002002	Adjustable setting, std setting 12 bar (174 psi)
SAE cavity 16/3Q		
LA16QA/0C0B	0LA16Q002000	Fixed setting, 10 bar (145 psi)
LA16QA/0R0B SB=12bar	0LA16Q002001	Adjustable setting, std setting 12 bar (174 psi)

2 Stand by	
Setting is referred to 1 l/min (0.26 US gpm) flow	
TYPE	DESCRIPTION
A	Fixed setting: 1 bar (14.5 psi)
B	Fixed setting: 5 bar (72.5 psi)
C	Fixed setting: 10 bar (145 psi)
R	Adjustable setting: from 8 to 15 bar (116 to 218 psi)

3 Lead sealing	
TYPE	DESCRIPTION
0	Without sealing
X	With sealing: for valves with adjustable stand-by only

4 Seals	
TYPE	DESCRIPTION
B	NBR (Buna) o-ring seals, std configuration
V	FPM (Viton) o-ring seals, contact Sales Dept.

5 Stand-by setting
To be specified only with adjustable stand-by valve

6 Valve body		
TYPE	CODE	DESCRIPTION
SAE 10/3Q-G 1/2	3CC1032D21	Steel body for cavity 08 valve, G 1/2 standard thread
SAE 16/3Q-G 3/4	3CC1632E21	Steel body for cavity 16 valve, G 3/4 standard thread

For aluminium bodies or different threading see from page 217

Rating diagrams

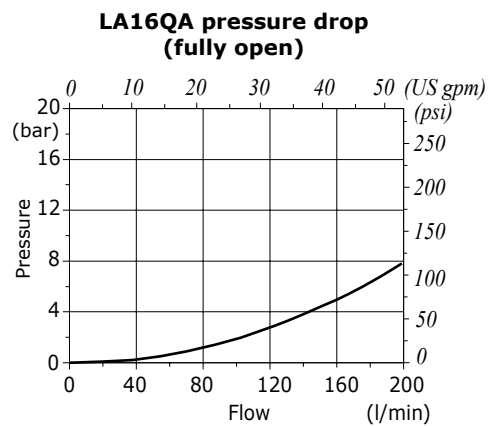
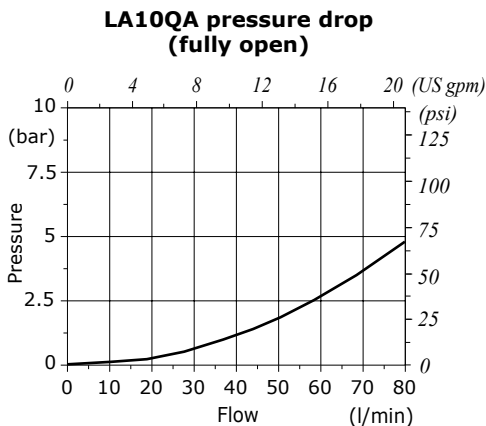



LB..QA type logic element - 3 way

- Venting to open configuration
- Fixed or adjustable Stand-by
- SAE10 and SAE16 cavities

Technical specifications and diagrams are measured with mineral oil of 46 cSt viscosity at 40°C (104°F) temperature.

	LB10QA	LB16QA
Nominal flow	80 l/min (21 US gpm)	190 l/min (50 US gpm)
Max. pressure	350 bar (5100 psi)	
Opening pressure	fixed setting: 5, 10 bar (72.5, 145 psi) adjustable setting: from 8 to 15 bar (116 to 218 psi)	
Oil leakage at 210 bar (3050 psi)	80 cm ³ /min (4.88 in ³ /min)	230 cm ³ /min (14.03 in ³ /min)
Fluid	mineral based oil	
Viscosity	10-200 cSt	
Max level of contamination	20/18/14 ISO4406	
Fluid temperature	with NBR seals with FPM seals	from -20°C (-4°F) to 80°C (176°F) from -20°C (-4°F) to 100°C (212°F)
Environmental temp. for working conditions	from -20°C (-4°F) to 50°C (122°F)	
Cavity	SAE 10/3Q	SAE 16/3Q
Weight	0.15 kg (0.33 lb)	0.45 kg (0.99 lb)

NOTE - For different conditions, please contact Walvoil Sales Dpt.

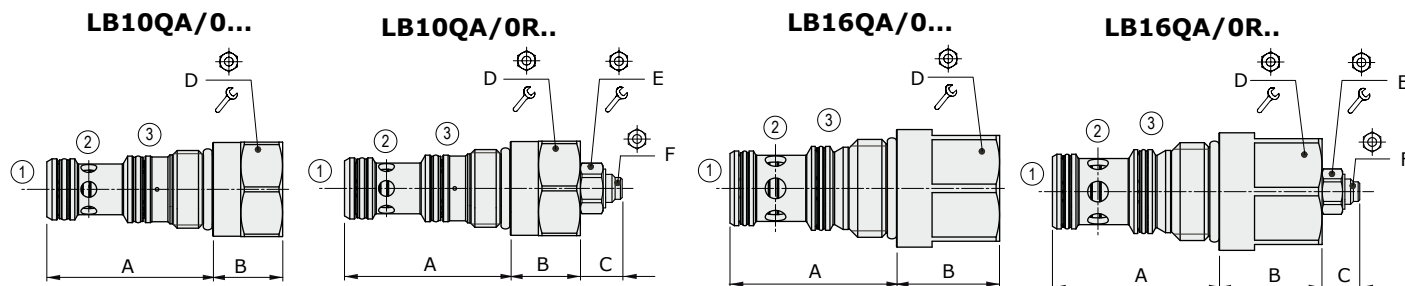
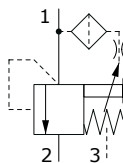

Valve type	A		B		C (max)		D		E		F		
	mm	in	mm	in	mm	in	Nm	lbft	Nm	lbft	mm		
LB10QA	47.6	1.87	20	0.79	21	0.83	27	70	52	13	9.8	7.2	3
LB16QA	56.9	2.24	35.1	1.38	24	0.94	36	100	74	13	9.8	7.2	3

Ordering codes and description composition

LB 10QA/0 B 0 B SB=12bar

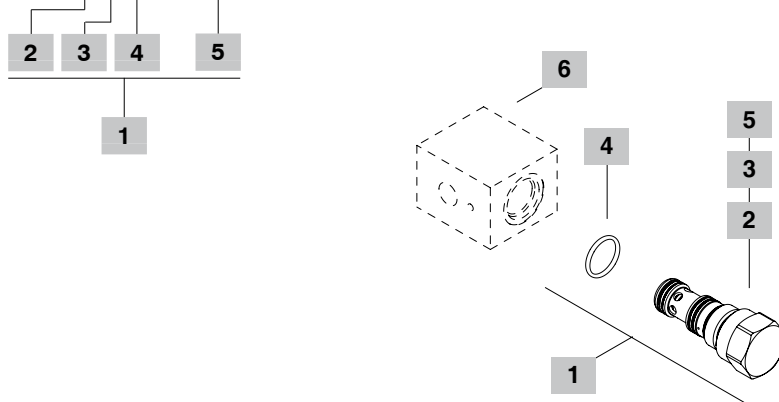

1 Cartridge		
TYPE	CODE	DESCRIPTION
SAE cavity 10/3Q		
LB10QA/0B0B	0LB10Q002000	Fixed setting, 5 bar (72.5 psi)
SAE cavity 16/3Q		
LB16QA/0B0B	0LB16Q002000	Fixed setting, 5 bar (72.5 psi)

2 Stand by	
TYPE	DESCRIPTION
B	Fixed setting: 5 bar (72.5 psi)
C	Fixed setting: 10 bar (145 psi)
R	Adjustable setting: from 8 to 15 bar (116 to 218 psi)

3 Lead sealing	
TYPE	DESCRIPTION
0	Without sealing
X	With sealing: for valves with adjustable stand-by only

4 Seals	
TYPE	DESCRIPTION
B	NBR (Buna) o-ring seals, std configuration
V	FPM (Viton) o-ring seals, contact Sales Dept.

5 Stand-by setting
To be specified only with adjustable stand-by valve

6 Valve body		
TYPE	CODE	DESCRIPTION
SAE 10/3Q-G 1/2	3CC1032D21	Steel body for cavity 08 valve, G 1/2 standard thread
SAE 16/3Q-G 3/4	3CC1632E21	Steel body for cavity 16 valve, G 3/4 standard thread

For aluminium bodies or different threading see from page 217

Rating diagrams

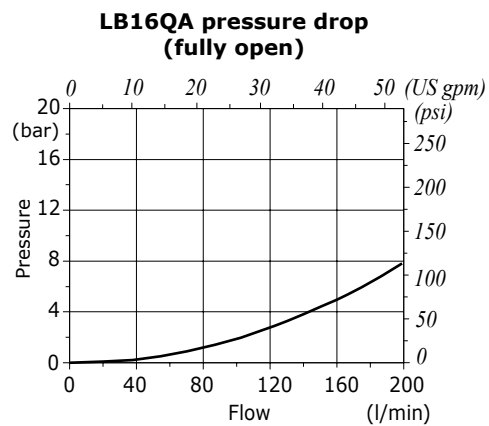
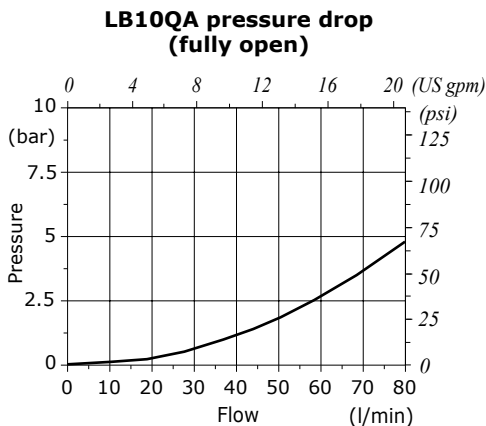



LC..QA type logic element - 3 way

- Venting to close configuration
- Fixed or adjustable Stand-by
- SAE10 and SAE16 cavities

Technical specifications and diagrams are measured with mineral oil of 46 cSt viscosity at 40°C (104°F) temperature.

	LC10QA	LC16QA
Nominal flow	60 l/min (16 US gpm)	150 l/min (39.6 US gpm)
Max. pressure	350 bar (5100 psi)	
Opening pressure	fixed setting: 5, 10 bar (72.5, 145 psi) adjustable setting: from 8 to 15 bar (116 to 218 psi)	
Oil leakage at 210 bar (3050 psi)	80 cm ³ /min (4.88 in ³ /min)	230 cm ³ /min (14.03 in ³ /min)
Fluid	mineral based oil	
Viscosity	10-200 cSt	
Max level of contamination	20/18/14 ISO4406	
Fluid temperature	with NBR seals with FPM seals	from -20°C (-4°F) to 80°C (176°F) from -20°C (-4°F) to 100°C (212°F)
Environmental temp. for working conditions	from -20°C (-4°F) to 50°C (122°F)	
Cavity	SAE 10/3Q	SAE 16/3Q
Weight	0.15 kg (0.33 lb)	0.45 kg (0.99 lb)

NOTE - For different conditions, please contact Walvoil Sales Dpt.

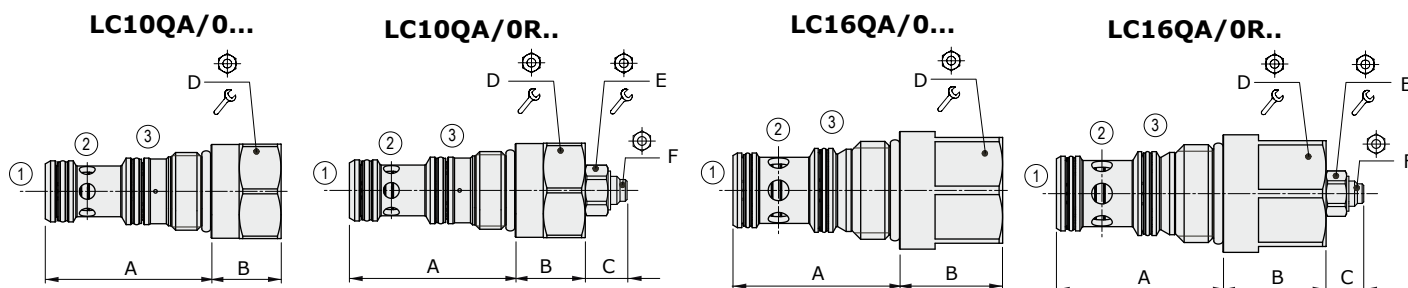
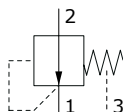

Valve type	A		B		C (max)		D		E		F		
	mm	in	mm	in	mm	in	Nm	lbft	Nm	lbft	mm		
LC10QA	47.6	1.87	20	0.79	21	0.83	27	70	52	13	9.8	7.2	3
LC16QA	56.9	2.24	35.1	1.38	24	0.94	36	100	74	13	9.8	7.2	3

Ordering codes and description composition

LC 10QA/0 B 0 B SB=12bar

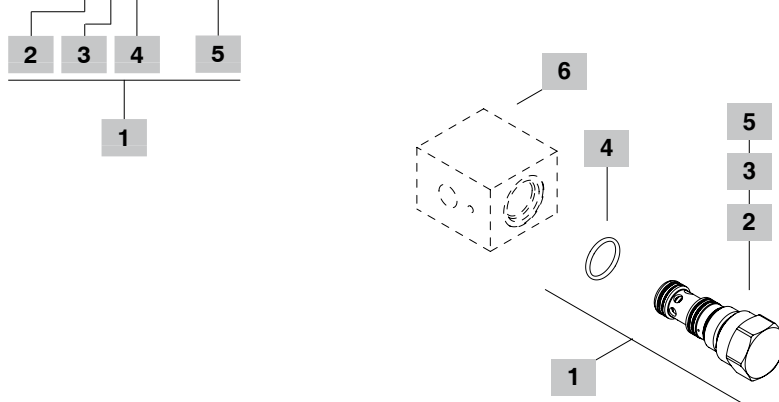

1 Cartridge		
TYPE	CODE	DESCRIPTION
SAE cavity 10/3Q		
LC10QA/0B0B	0LC10Q002001	Fixed setting, 5 bar (72.5 psi)
SAE cavity 16/3Q		
LC16QA/0B0B	0LC16Q002001	Fixed setting, 5 bar (72.5 psi)

2 Stand by	
Setting is referred to 1 l/min (0.26 US gpm) flow	
TYPE	DESCRIPTION
B	Fixed setting: 5 bar (72.5 psi)
C	Fixed setting: 10 bar (145 psi)
R	Adjustable setting: from 8 to 15 bar (116 to 218 psi)

3 Lead sealing	
TYPE	DESCRIPTION
0	Without sealing
X	With sealing: for valves with adjustable stand-by only

4 Seals	
TYPE	DESCRIPTION
B	NBR (Buna) o-ring seals, std configuration
V	FPM (Viton) o-ring seals, contact Sales Dept.

5 Stand-by setting
To be specified only with adjustable stand-by valve

6 Valve body		
TYPE	CODE	DESCRIPTION
SAE 10/3Q-G 1/2	3CC1032D21	Steel body for cavity 08 valve, G 1/2 standard thread
SAE 16/3Q-G 3/4	3CC1632E21	Steel body for cavity 16 valve, G 3/4 standard thread

For aluminium bodies or different threading see from page 217

Rating diagrams

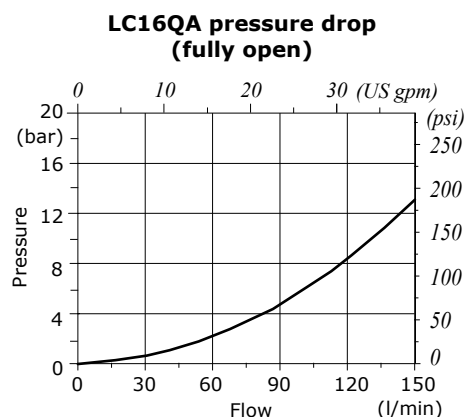
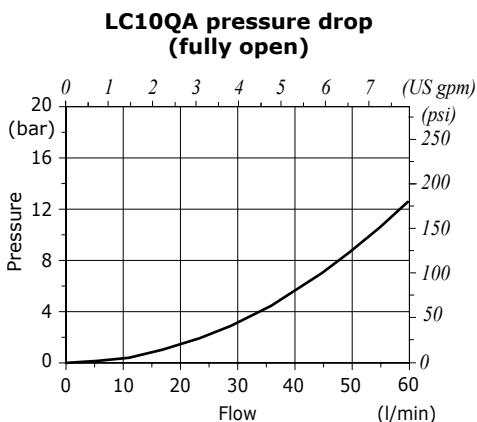



LD..QA typr logic element - 3 way

- Pilot to open configurationj
- Fixed or adjustable Stand-by
- SAE10 and SAE16 cavities

Technical specifications and diagrams are measured with mineral oil of 46 cSt viscosity at 40°C (104°F) temperature.

	LD10QA	LD16QA
Nominal flow	60 l/min (16 US gpm)	150 l/min (39.6 US gpm)
Max. pressure	350 bar (5100 psi)	
Opening pressure	fixed setting: 1, 5, 10 bar (14.5, 72.5, 145 psi) adjustable setting: from 8 to 15 bar (116 to 218 psi)	
Oil leakage	at 210 bar (3050 psi) 80 cm ³ /min (4.88 in ³ /min)	230 cm ³ /min (14.03 in ³ /min)
Fluid	mineral based oil	
Viscosity	10-200 cSt	
Max level of contamination	20/18/14 ISO4406	
Fluid temperature	with NBR seals with FPM seals	from -20°C (-4°F) to 80°C (176°F) from -20°C (-4°F) to 100°C (212°F)
Environmental temp. for working conditions	from -20°C (-4°F) to 50°C (122°F)	
Cavity	SAE 10/3Q	SAE 16/3Q
Weight	0.15 kg (0.33 lb)	0.45 kg (0.99 lb)

NOTE - For different conditions, please contact Walvoil Sales Dpt.

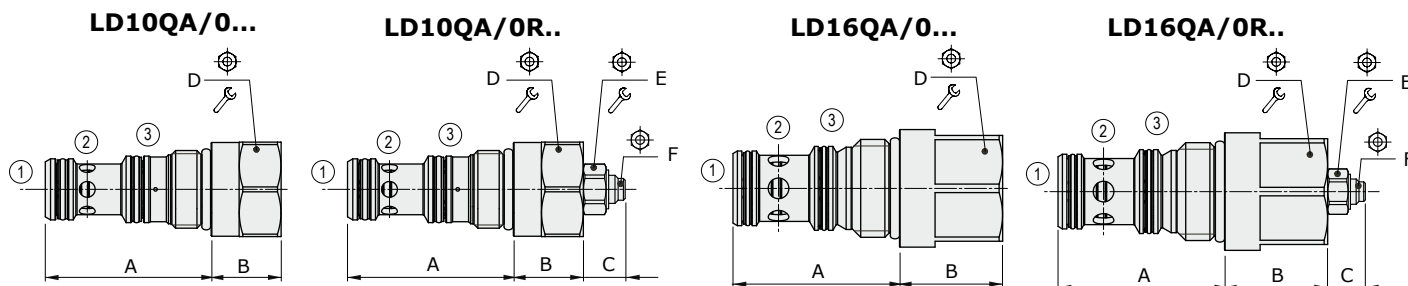
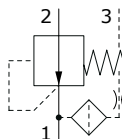

Valve type	A		B		C (max)		D		E		F		
	mm	in	mm	in	mm	in	Nm	lbft	Nm	lbft	mm		
LD10QA	47.6	1.87	20	0.79	21	0.83	27	70	52	13	9.8	7.2	3
LD16QA	56.9	2.24	35.1	1.38	24	0.94	36	100	74	13	9.8	7.2	3

Ordering codes and description composition

LD 10QA/0 B 0 B SB=12bar

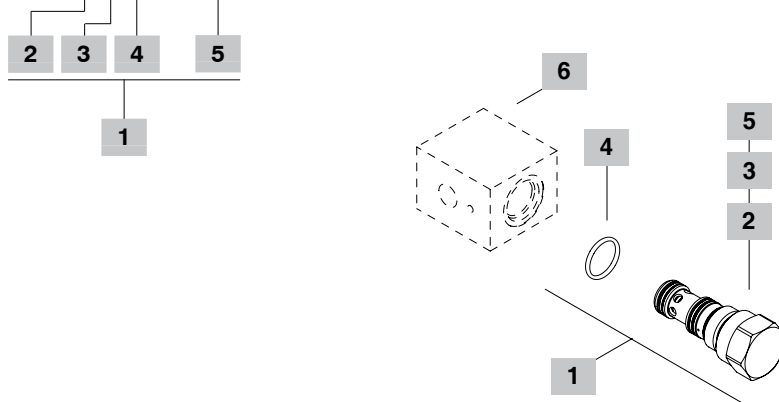

1 Cartridge

TYPE	CODE	DESCRIPTION
SAE cavity 10/3Q		
LD10QA/0B0B	0LD10Q002000	Fixed setting, 5 bar (72.5 psi)
SAE cavity 16/3Q		
LD16QA/0B0B	0LD16Q002000	Fixed setting, 5 bar (72.5 psi)

2 Stand by

Setting is referred to 1 l/min (0.26 US gpm) flow

TYPE	DESCRIPTION
A	Fixed setting: 1 bar (14.5 psi)
B	Fixed setting: 5 bar (72.5 psi)
C	Fixed setting: 10 bar (145 psi)
R	Adjustable setting: from 8 to 15 bar (116 to 218 psi)

3 Lead sealing

TYPE	DESCRIPTION
0	Without sealing
X	With sealing: for valves with adjustable stand-by only

4 Seals

TYPE	DESCRIPTION
B	NBR (Buna) o-ring seals, std configuration
V	FPM (Viton) o-ring seals, contact Sales Dept.

5 Stand-by setting

To be specified only with adjustable stand-by valve

6 Valve body

TYPE	CODE	DESCRIPTION
SAE 10/3Q-G 1/2	3CC1032D21	Steel body for cavity 08 valve, G 1/2 standard thread
SAE 16/3Q-G 3/4	3CC1632E21	Steel body for cavity 16 valve, G 3/4 standard thread

For aluminium bodies or different threading see from page 217

Rating diagrams

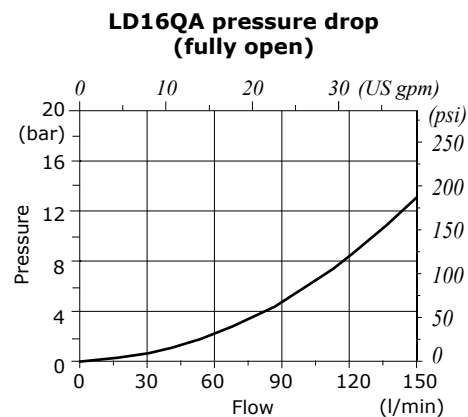
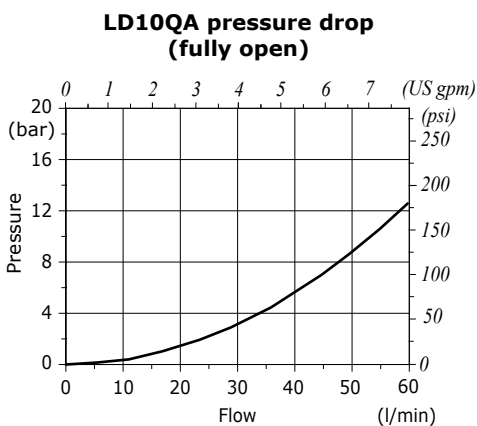



EA08 type directional solenoid valve - 2 way / 2 positions

- Direct acting
- Poppet type
- Normally open and closed configurations

Technical specifications and diagrams are measured with mineral oil of 46 cSt viscosity at 40°C (104°F) temperature.

	EA08A	EA08B
Nominal flow	1 l/min (0.26 US gpm)	1 l/min (0.26 US gpm)
Max. pressure	210 bar (3050 psi)	350 bar (5100 psi)
Oil leakage	at 210 bar (3050 psi)	0.25 cm ³ /min (0.015 in ³ /min)
Fluid	mineral based oil	
Viscosity	10-200 cSt	
Max level of contamination	18/16/13 ISO4406	
Fluid temperature	with NBR seals with FPM seals	from -20°C (-4°F) to 80°C (176°F) from -20°C (-4°F) to 100°C (212°F)
Environmental temp. for working conditions	from -20°C (-4°F) to 50°C (122°F)	
Cavity	SAE 8/2	
Coil type*	BE	BT
Nominal voltages	12 VDC - 24 VDC ± 10%	12 VDC - 24 VDC ± 10%
Power rating	18.7 W (12 VDC) 18.6 W (24 VDC)	21 W (12-24 VDC)
Weight	0.130 kg (0.28 lb)	0.130 kg (0.28 lb)

NOTE - For different conditions, please contact Walvoil Sales Dpt. - *For coils further features see from page 206.

Normally open configuration

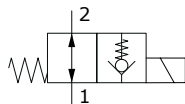

Normally closed configuration

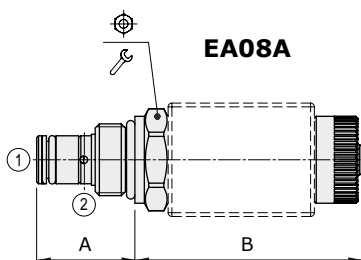
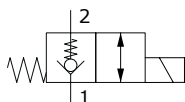

Valve type	A		B				Nm	lbft
	mm	in	mm	in				
EA08A/	10NB	27.5	1.08	60	2.36	24	30	22
	20NB	27.5	1.08	59	2.32	24	30	22
EA08B/	10NB	27.5	1.08	70.9	2.79	24	30	22
	20NB	27.5	1.08	65.5	2.58	24	30	22

For dimensions with different type of emergency see page 213

Ordering codes and description composition

EA08A/10 NB

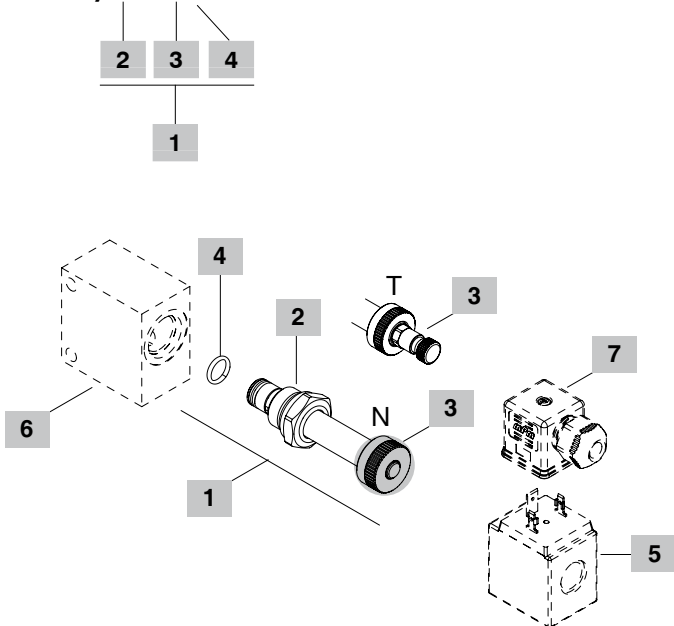

2 Spool

TYPE	DESCRIPTION
1	Normally open configuration
2	Normally closed configuration

3 Emergency

TYPE	DESCRIPTION
N	Without emergency
T	Screw type

Note: for configurations with different emergency contact Sales Dept.

4 Seals

TYPE	DESCRIPTION
B	NBR (Buna) o-ring seals, std configuration
V	FPM (Viton) o-ring seals, contact Sales Dept.

5 Coils

TYPE	CODE	DESCRIPTION
BE 12VDC	4SL1000120	12VDC-ISO4400 coil for EA08A
BT 12VDC	4SL3000120	12VDC-ISO4400 coil for EA08B

For complete coils list see page 206

6 Valve body

TYPE	CODE	DESCRIPTION
SAE 08/2-SAE6	3CC0820J11	Aluminium body for cavity 08 valve, SAE6 std thread

Note: aluminium body can stand up to 210 bar (3050 psi)
For steel bodies or different threading see from page 215

7 Connector

TYPE	CODE	DESCRIPTION
ISO4400	4CN1009995	Connector

For complete connectors list see page 206

1 Cartridges

TYPE	CODE	DESCRIPTION
SAE cavity 08/2		
EA08A/10NB	0EA08002001	Normally open configuration (N.O.) without emergency
EA08B/10NB	0EA08002003	(N.O.) without emergency
EA08A/10TB	0EA08002007	(N.O.) screw type emergency
EA08B/10TB	0EA08002005	(N.O.) screw type emergency
EA08A/20NB	0EA08002000	Normally closed configuration (N.C.) without emergency
EA08B/20NB	0EA08002002	(N.C.) without emergency
EA08A/20TB	0EA08002009	(N.C.) screw type emergency
EA08B/20TB	0EA08002004	(N.C.) screw type emergency

Rating diagrams

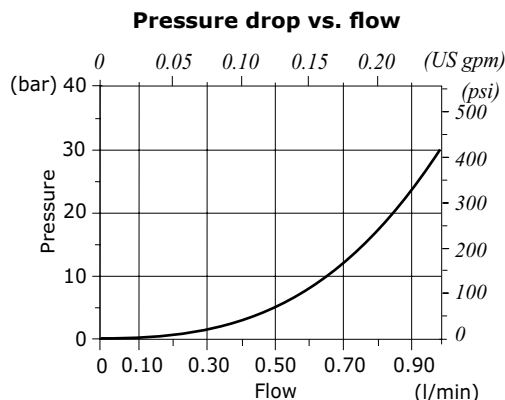



EE..A type directional solenoid valves - 2 way / 2 positions

- Direct acting
- Spool type
- Normally open and closed configurations
- From SAE08 to SAE12 cavities

Technical specifications and diagrams are measured with mineral oil of 46 cSt viscosity at 40°C (104°F) temperature.

	EE08A	EE10A	EE12A
Nominal flow	8 l/min (2.11 US gpm)	30 l/min (7.9 US gpm)	40 l/min (10.5 US gpm)
Max. pressure	210 bar (3050 psi)		
Oil leakage	at 210 bar (3050 psi) 30 cm ³ /min (1.83 in ³ /min)	55 cm ³ /min (3.35 in ³ /min)	75 cm ³ /min (4.58 in ³ /min)
Fluid	mineral based oil		
Viscosity	10-200 cSt		
Max level of contamination	18/16/13 ISO4406		
Fluid temperature	with NBR seals with FPM seals	from -20°C (-4°F) to 80°C (176°F) from -20°C (-4°F) to 100°C (212°F)	
Environmental temp. for working conditions	from -20°C (-4°F) to 50°C (122°F)		
Cavity	SAE 08/2	SAE 10/2	SAE 12/2
Coil type*	BER	BIN 19	BIN 22
Nominal voltages	12 VDC - 24 VDC ± 10%		
Power rating	22.8 W (12 VDC) 22.5 W (24 VDC)	29 W (12 VDC) 31 W (24 VDC)	32.6 W (12 VDC) 31 W (24 VDC)
Weight	0.18 kg (0.40 lb)	0.28 kg (0.64 lb)	0.44 kg (0.97 lb)

NOTE - For different conditions, please contact Walvoil Sales Dpt. - *For coils further features see from page 206.

Normally open configuration

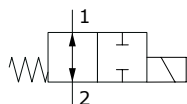

Normally closed configuration

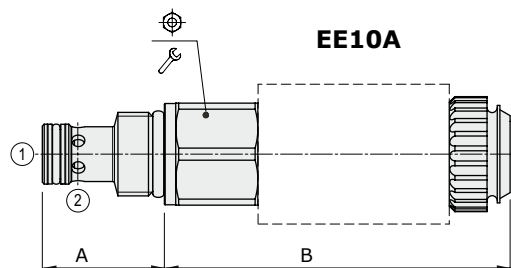
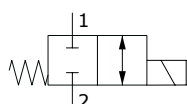

Valve type	A		B				Nm	lbft
	mm	in	mm	in				
EE08A/	10NB	27.6	1.09	76	2.99	24	30	22
	20NB	27.6	1.09	76	2.99	24	30	22
EE10A/	10PB	32.3	1.27	90.3	3.56	27	50	37
	20PB	32.3	1.27	90.3	3.56	27	50	37
EE12A/	10PB	46	1.81	102	4.02	32	80	59
	20PB	46	1.81	90.3	3.56	32	80	59

Ordering codes and description composition

EE08A/10 NB

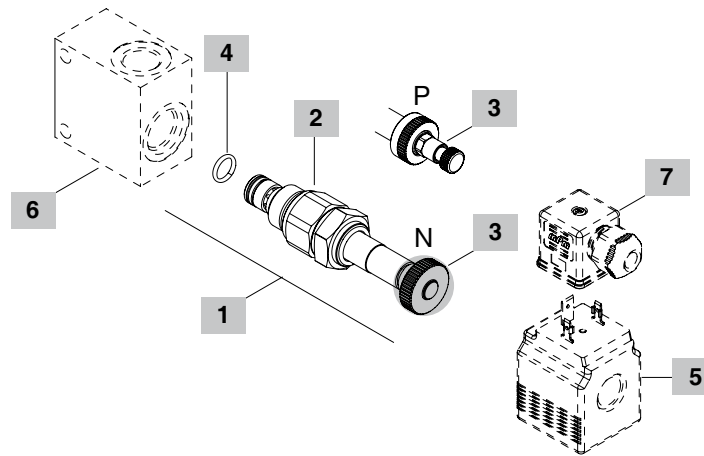
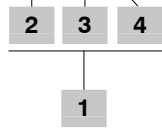

1 Cartridges

TYPE	CODE	DESCRIPTION
SAE cavity 08/2		
EE08A/10NB	0EE08002001	Normally open configuration (N.O.) without emergency
EE08A/20NB	0EE08002000	Normally closed configuration (N.C.) without emergency
SAE cavity 10/2		
EE10A/10PB	0EE10002003	Normally open configuration (N.O.) with push-button emergency
EE10A/20PB	0EE10002002	Normally closed configuration (N.C.) with push-button emergency
SAE cavity 12/2		
EE12A/10PB	0EE12002005	Normally open configuration (N.O.) with push-button emergency
EE12A/20PB	0EE12002004	Normally closed configuration (N.C.) with push-button emergency

2 Spool

TYPE	DESCRIPTION
1	Normally open configuration
2	Normally closed configuration

3 Emergency

TYPE	DESCRIPTION
N	Without emergency only for 8/2
P	Push button type only for 10/2 and 12/2

Note: for configurations with different emergency contact Sales Dept.

4 Seals

TYPE	DESCRIPTION
B	NBR (Buna) o-ring seals, std configuration
V	FPM (Viton) o-ring seals, contact Sales Dept.

5 Coils

TYPE	CODE	DESCRIPTION
BER 12 VDC	4SLE001200	12VDC-ISO4400 coil for EE08A
BIN 19 VDC	4SL6000121	12VDC-ISO4400 coil for EE10A
BIN 22 VDC	4SL6000128	12VDC-ISO4400 coil for EE12A

For complete coils list see from page 206

6 Valve body

TYPE	CODE	DESCRIPTION
SAE 08/2-SAE8	3CC0820K11	Aluminium body for cavity 08 valve, SAE8 std thread
SAE 10/2-SAE8	3CC1020K11	Aluminium body for cavity 08 valve, SAE8 std thread
SAE 12/2-SAE10	3CC1220L11	Aluminium body for cavity 12 valve, SAE10 std thread

For steel bodies or different threading see from page 215

7 Connector

TYPE	CODE	DESCRIPTION
ISO4400	4CN1009995	Connector

For complete connectors list see from page 206

Rating diagrams

EE08A pressure drop vs. flow
 - Spool 1 -

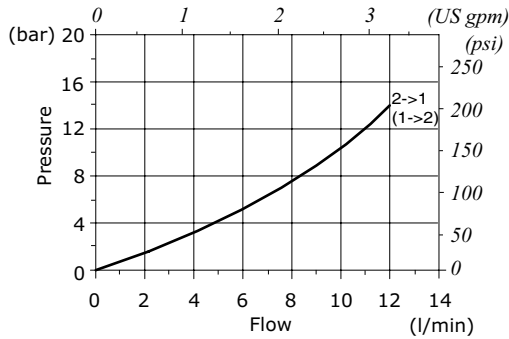

EE08A pressure drop vs. flow
 - Spool 2 -

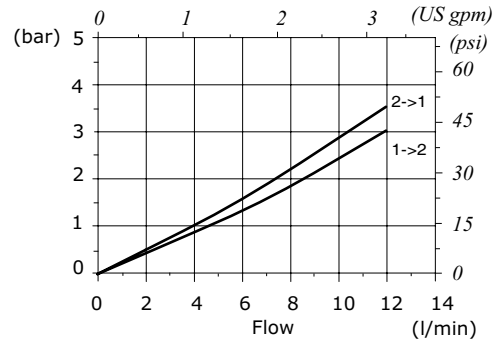

EE10A pressure drop vs. flow
 - Spool 1 -

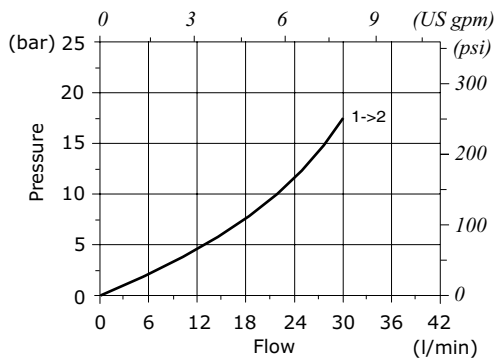

EE10A pressure drop vs. flow
 - Spool 2 -

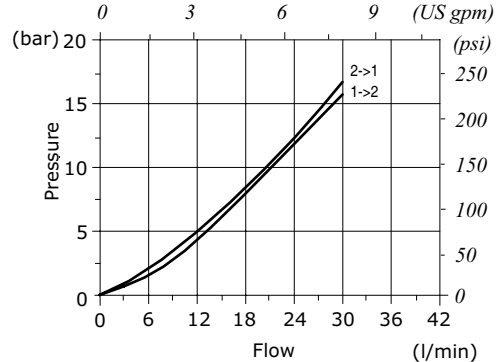

EE12A pressure drop vs. flow
 - Spool 1 -

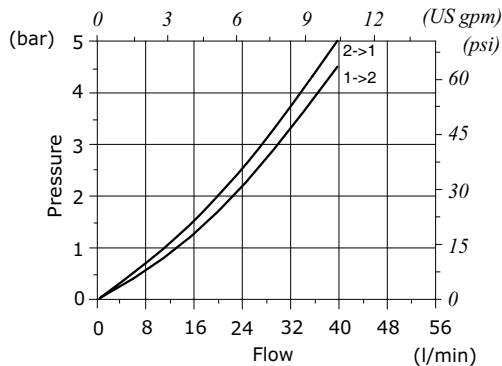

EE12A pressure drop vs. flow
 - Spool 2 -

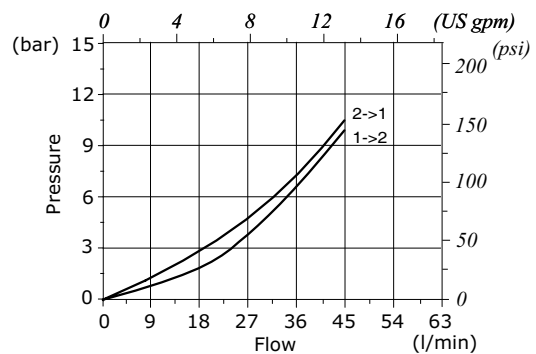



EC..M type directional solenoid valves - 2 way / 2 positions

- Pilot operated
- Poppet type
- Oil leakage free from port 2 to port 1
- Normally open and closed configurations
- From SAE08 to SAE16 cavities

Technical specifications and diagrams are measured with mineral oil of 46 cSt viscosity at 40°C (104°F) temperature.

		EC08M	EC10M	EC12M	EC16M
Nominal flow		40 l/min (10.5 US gpm)	70 l/min (18.5 US gpm)	150 l/min (40 US gpm)	150 l/min (40 US gpm)
Max. pressure		380 bar (5500 psi)			
Oil leakage	at 210 bar (3050 psi)	0.25 cm ³ /min (0.015 in ³ /min)	0.25 cm ³ /min (0.015 in ³ /min)	0.25 cm ³ /min (0.015 in ³ /min)	0.25 cm ³ /min (0.015 in ³ /min)
Fluid		mineral based oil			
Viscosity		10-200 cSt			
Max level of contamination		18/16/13 ISO4406			
Fluid temperature	with NBR seals with FPM seals	from -20°C (-4°F) to 80°C (176°F) from -20°C (-4°F) to 100°C (212°F)			
Environmental temp. for working conditions		from -20°C (-4°F) to 50°C (122°F)			
Cavity		SAE 08/2	SAE 10/2	SAE 12/2	SAE 16/2
Coil type*		BER			
Nominal voltages		12 VDC - 24 VDC ± 10%			
Power rating		19.2 W (12 VDC - 24 VDC)			
Weight		0.135 kg (0.30 lb)	0.170 kg (0.37 lb)	0.230 kg (0.51 lb)	0.315 kg (0.69 lb)

NOTE - For different conditions, please contact Walvoil Sales Dpt. - *For coils further features see from page 206.

Normally open configuration

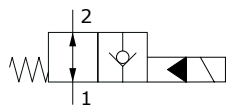

Normally closed configuration

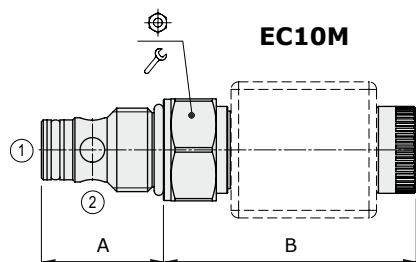
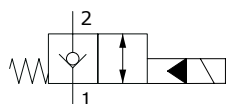

Valve type	A		B				Nm	lbft
	mm	in	mm	in				
EC08M/	10NB	28	1.10	67.2	2.64	24	30	22
	20NB	28	1.10	63.3	2.49	24	30	22
EC10M/	10NB	32.3	1.27	66.9	2.63	27	50	37
	20NB	32.3	1.27	63	2.48	27	50	37
EC12M/	10NB	45	1.77	61.1	2.40	32	80	59
	20NB	45	1.77	57.2	2.25	32	80	59
EC16M/	10NB	46	1.81	61.2	2.41	38	80	59
	20NB	46	1.81	57.3	2.26	38	80	59

For dimensions with different type of emergency see page 213

Ordering codes and description composition

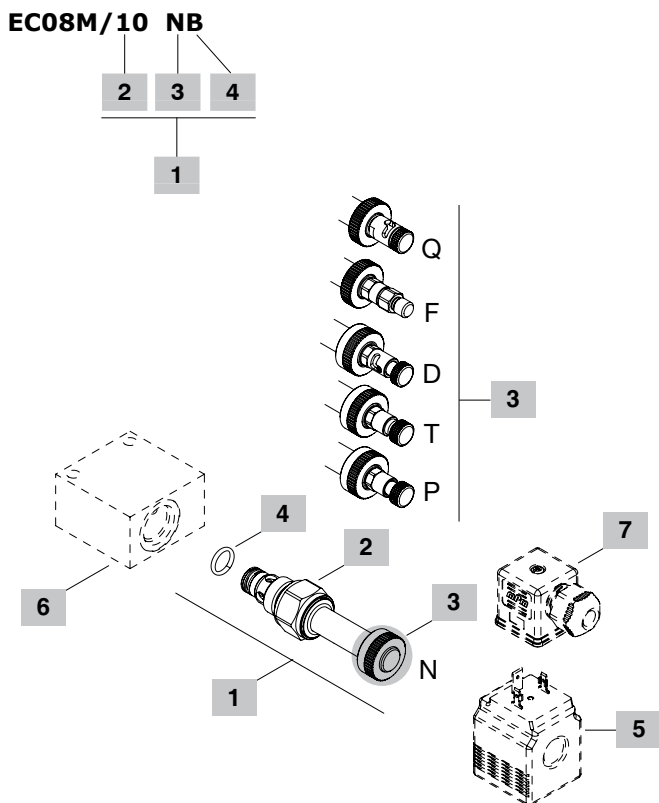

1 Cartucce

TYPE	CODE	DESCRIPTION
SAE cavity 08/2		
EC08M/10NB	0EC08002031	Normally open (N.O.) without emergency
EC08M/10PB	0EC08002033	(N.O.) push button emergency
EC08M/10TB	0EC08002034	(N.O.) screw type emergency
EC08M/10DB	0EC08002035	(N.O.) push type with detent emergency
EC08M/20NB	0EC08002032	Normally closed (N.C.) without emergency
EC08M/20FB	0EC08002036	(N.C.) pull button emergency
EC08M/20TB	0EC08002037	(N.C.) screw type emergency
EC08M/20QB	0EC08002038	(N.C.) pull type with detent emergency
SAE cavity 10/2		
EC10M/10NB	0EC10002012	Normally open (N.O.) without emergency
EC10M/10PB	0EC10002014	(N.O.) push button emergency
EC10M/10TB	0EC10002015	(N.O.) screw type emergency
EC10M/10DB	0EC10002016	(N.O.) push type with detent emergency
EC10M/20NB	0EC10002013	Normally closed (N.C.) without emergency
EC10M/20FB	0EC10002017	(N.C.) pull button emergency
EC10M/20TB	0EC10002018	(N.C.) screw type emergency
EC10M/20QB	0EC10002019	(N.C.) pull type with detent emergency
SAE cavity 12/2		
EC12M/10NB	0EC12002007	Normally open (N.O.) without emergency
EC12M/10PB	0EC12002009	(N.O.) push button emergency
EC12M/10TB	0EC12002010	(N.O.) screw type emergency
EC12M/10DB	0EC12002011	(N.O.) push type with detent emergency
EC12M/20NB	0EC12002008	Normally closed (N.C.) without emergency
EC12M/20FB	0EC12002012	(N.C.) pull button emergency
EC12M/20TB	0EC12002013	(N.C.) screw type emergency
EC12M/20QB	0EC12002014	(N.C.) pull type with detent emergency
SAE cavity 16/2		
EC16M/10NB	0EC16002020	Normally open (N.O.) without emergency
EC16M/10PB	0EC16002022	(N.O.) push button emergency
EC16M/10TB	0EC16002023	(N.O.) screw type emergency
EC16M/10DB	0EC16002024	(N.O.) push type with detent emergency
EC16M/20NB	0EC16002021	Normally closed (N.C.) without emergency
EC16M/20FB	0EC16002025	(N.C.) pull button emergency
EC16M/20TB	0EC16002026	(N.C.) screw type emergency
EC16M/20QB	0EC16002027	(N.C.) pull type with detent emergency

2 Spool

TYPE	DESCRIPTION
1	Normally open configuration
2	Normally closed configuration

3 Emergency

TYPE	DESCRIPTION
N	Without emergency
P	Push button type (N.O.)
T	Screw type
D	Push type with detent (N.O.)
F	Pull button type (N.C.)
Q	Pull type with detent (N.C.)

4 Seals

TYPE	DESCRIPTION
B	NBR (Buna) o-ring seals, std configuration
V	FPM (Viton) o-ring seals, contact Sales Dept

5 Coil

TYPE	CODE	DESCRIPTION
BER 12VDC	4SLE001200	12VDC-ISO4400 coil

For complete coils list see from page 206

6 Valve body

TYPE	CODE	DESCRIPTION
SAE 08/2-SAE8	3CC0820K11	Aluminium body for cavity 08 valve, SAE8 std thread
SAE 10/2-SAE8	3CC1020K11	Aluminium body for cavity 10 valve, SAE8 std thread
SAE 12/2-SAE10	3CC1220L11	Aluminium body for cavity 12 valve, SAE10 std thread
SAE 16/2-SAE12	3CC1620M11	Aluminium body for cavity 16 valve, SAE12 std thread

Note: aluminium body can stand up to 210 bar (3050 psi)
For steel bodies or different threading see from page 215

7 Connetture

TYPE	CODE	DESCRIPTION
ISO4400	4CN1009995	Connector

For complete connectors list see from page 206

Rating diagrams

EC08M/10NB - EC08M/20N
 pressure drop vs. flow

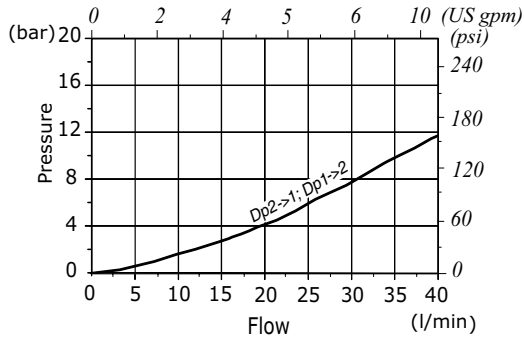

EC10M/10NB - EC10M/20NB
 pressure drop vs. flow

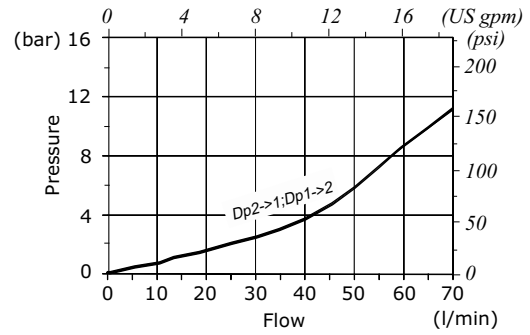

EC12M/10NB - EC16M/10NB
 pressure drop vs. flow

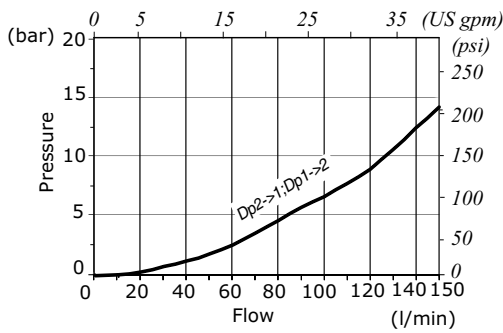

EC12M/20NB - EC16M/20NB
 pressure drop vs. flow

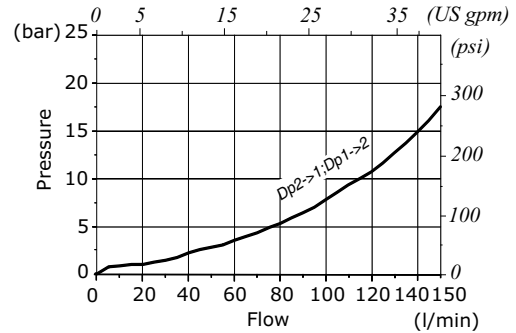



EF..M type directional solenoid valves - 2 way / 2 positions

- Pilot operated
- Poppet type
- Oil leakage free from port 1 to port 2
- Normally open and closed configurations
- From SAE08 to SAE16 cavities

Technical specifications and diagrams are measured with mineral oil of 46 cSt viscosity at 40°C (104°F) temperature.

		EF08M	EF10M	EF12M	EF16M
Nominal flow		40 l/min (10.5 US gpm)	70 l/min (18.5 US gpm)	150 l/min (40 US gpm)	150 l/min (40 US gpm)
Max. pressure		380 bar (5500 psi)			
Oil leakage	at 210 bar (3050 psi)	0.50 cm ³ /min (0.030 in ³ /min)	0.50 cm ³ /min (0.030 in ³ /min)	0.50 cm ³ /min (0.030 in ³ /min)	0.50 cm ³ /min (0.030 in ³ /min)
Fluid		mineral based oil			
Viscosity		10-200 cSt			
Max level of contamination		18/16/13 ISO4406			
Fluid temperature	with NBR seals with FPM seals	from -20°C (-4°F) to 80°C (176°F) from -20°C (-4°F) to 100°C (212°F)			
Environmental temp. for working conditions		from -20°C (-4°F) to 50°C (122°F)			
Cavity		SAE 08/2	SAE 10/2	SAE 12/2	SAE 16/2
Coil type*		BER			
Nominal voltages		12 VDC - 24 VDC ± 10%			
Power rating		22.8 W (12 VDC) - 22.5 W (24 VDC)			
Weight		0.135 kg (0.30 lb)	0.170 kg (0.37 lb)	0.230 kg (0.51 lb)	0.315 kg (0.69 lb)

NOTE - For different conditions, please contact Walvoil Sales Dpt. - *For coils further features see from page 206.

Normally open configuration

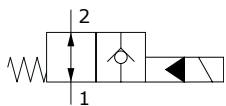

Normally closed configuration

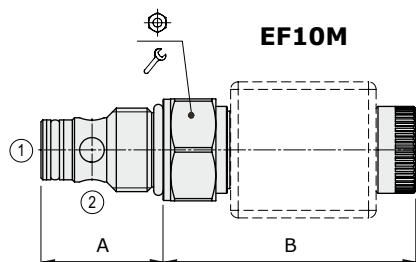
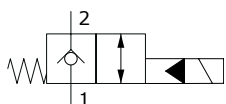

Valve type	A		B				Nm	lbft
	mm	in	mm	in				
EF08M/	10NB	28	1.10	67.2	2.64	24	30	22
	20NB	28	1.10	63.3	2.49	24	30	22
EF10M/	10NB	32.3	1.27	66.9	2.63	27	50	37
	20NB	32.3	1.27	63	2.48	27	50	37
EF12M/	10NB	45	1.77	61.1	2.40	32	80	59
	20NB	45	1.77	57.2	2.25	32	80	59
EF16M/	10NB	46	1.81	61.2	2.41	38	80	59
	20NB	46	1.81	57.3	2.26	38	80	59

For dimensions with different type of emergency see page 213

Ordering codes and description composition

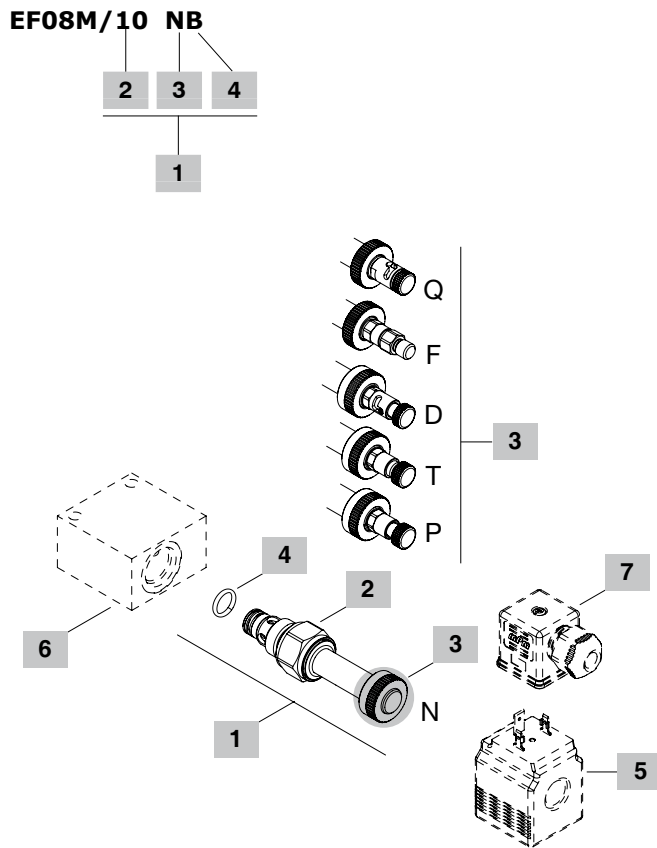

1 Cartucce

TYPE	CODE	DESCRIPTION
SAE cavity 08/2		
EF08M/10NB	0EF08002000	Normally open (N.O.) without emergency
EF08M/10PB	0EF08002002	(N.O.) push button emergency
EF08M/10TB	0EF08002003	(N.O.) screw type emergency
EF08M/10DB	0EF08002004	(N.O.) push type with detent emergency
EF08M/20NB	0EF08002001	Normally closed (N.C.) without emergency
EF08M/20FB	0EF08002005	(N.C.) pull button emergency
EF08M/20TB	0EF08002006	(N.C.) screw type emergency
EF08M/20QB	0EF08002007	(N.C.) pull type with detent emergency
SAE cavity 10/2		
EF10M/10NB	0EF10002000	Normally open (N.O.) without emergency
EF10M/10PB	0EF10002002	(N.O.) push button emergency
EF10M/10TB	0EF10002003	(N.O.) screw type emergency
EF10M/10DB	0EF10002004	(N.O.) push type with detent emergency
EF10M/20NB	0EF10002001	Normally closed (N.C.) without emergency
EF10M/20FB	0EF10002005	(N.C.) pull button emergency
EF10M/20TB	0EF10002006	(N.C.) screw type emergency
EF10M/20QB	0EF10002007	(N.C.) pull type with detent emergency
SAE cavity 12/2		
EF12M/10NB	0EF12002000	Normally open (N.O.) without emergency
EF12M/10PB	0EF12002002	(N.O.) push button emergency
EF12M/10TB	0EF12002003	(N.O.) screw type emergency
EF12M/10DB	0EF12002004	(N.O.) push type with detent emergency
EF12M/20NB	0EF12002001	Normally closed (N.C.) without emergency
EF12M/20FB	0EF12002005	(N.C.) pull button emergency
EF12M/20TB	0EF12002006	(N.C.) screw type emergency
EF12M/20QB	0EF12002007	(N.C.) pull type with detent emergency
SAE cavity 16/2		
EF16M/10NB	0EF16002000	Normally open (N.O.) without emergency
EF16M/10PB	0EF16002002	(N.O.) push button emergency
EF16M/10TB	0EF16002003	(N.O.) screw type emergency
EF16M/10DB	0EF16002004	(N.O.) push type with detent emergency
EF16M/20NB	0EF16002001	Normally closed (N.C.) without emergency
EF16M/20FB	0EF16002005	(N.C.) pull button emergency
EF16M/20TB	0EF16002006	(N.C.) screw type emergency
EF16M/20QB	0EF16002007	(N.C.) pull type with detent emergency

2 Spool

TYPE	DESCRIPTION
1	Normally open configuration
2	Normally closed configuration

3 Emergency

TYPE	DESCRIPTION
N	Without emergency
P	Push button type (N.O.)
T	Screw type
D	Push type with detent (N.O.)
F	Pull button type (N.C.)
Q	Pull type with detent (N.C.)

4 Seals

TYPE	DESCRIPTION
B	NBR (Buna) o-ring seals, std configuration
V	FPM (Viton) o-ring seals, contact Sales Dept.

5 Coils

TYPE	CODE	DESCRIPTION
BER 12VDC	4SLE001200	12VDC-ISO4400 coil

For complete coils list see from page 206

6 Valve body

TYPE	CODE	DESCRIPTION
SAE 08/2-SAE8	3CC0820K11	Aluminium body for cavity 08 valve, SAE8 std thread
SAE 10/2-SAE8	3CC1020K11	Aluminium body for cavity 10 valve, SAE8 std thread
SAE 12/2-SAE10	3CC1220L11	Aluminium body for cavity 12 valve, SAE10 std thread
SAE 16/2-SAE12	3CC1620M11	Aluminium body for cavity 16 valve, SAE12 std thread

Note: aluminium body can stand up to 210 bar (3050 psi)
For steel bodies or different threading see from page 215

7 Connector

TYPE	CODE	DESCRIPTION
ISO4400	4CN1009995	Connector

For complete connectors list see from page 206

Rating diagrams

EF08M/10NB - EF08M/20NB
 pressure drop vs. flow

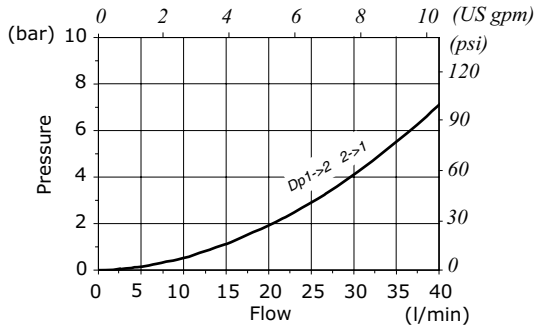

EF10M/10NB - EF10M/20NB
 pressure drop vs. flow

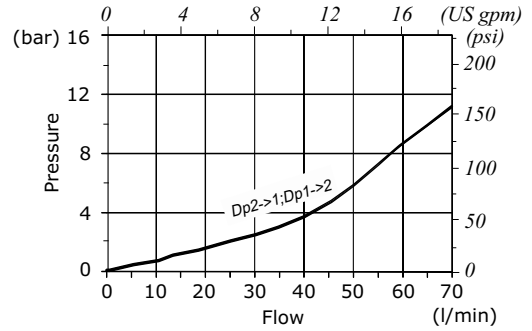

EF12M/10NB - EF16M/10NB
 pressure drop vs. flow

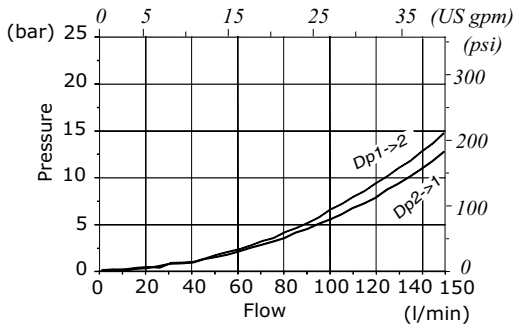

EF12M/20NB - EF16M/20NB
 pressure drop vs. flow

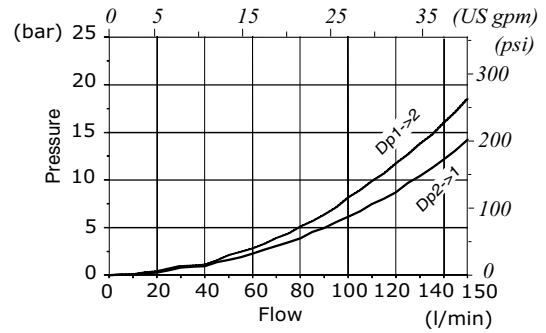



EH..M type directional solenoid valves - 2 way / 2 positions

- Pilot operated
- Poppet type
- With check in both directions
- Normally open and closed configurations
- From SAE08 to SAE16 cavities

Technical specifications and diagrams are measured with mineral oil of 46 cSt viscosity at 40°C (104°F) temperature.

		EH08M	EH10M	EH12M	EH16M
Nominal flow		40 l/min (10.5 US gpm)	70 l/min (18.5 US gpm)	150 l/min (40 US gpm)	150 l/min (40 US gpm)
Max. pressure		380 bar (5500 psi)	380 bar (5500 psi)	350 bar (5100 psi)	380 bar (5500 psi)
Oil leakage	at 210 bar (3050 psi)	0.50 cm ³ /min (0.030 in ³ /min)	0.50 cm ³ /min (0.030 in ³ /min)	1 cm ³ /min (0.061 in ³ /min)	1 cm ³ /min (0.061 in ³ /min)
Fluid		mineral based oil			
Viscosity		10-200 cSt			
Max level of contamination		18/16/13 ISO4406			
Fluid temperature	with NBR seals with FPM seals	from -20°C (-4°F) to 80°C (176°F) from -20°C (-4°F) to 100°C (212°F)			
Environmental temp. for working conditions		from -20°C (-4°F) to 50°C (122°F)			
Cavity		SAE 08/2	SAE 10/2	SAE 12/2	SAE 16/2
Coil type*		BER			
Nominal voltages		12 VDC - 24 VDC ± 10%			
Power rating		22.8 W (12 VDC) - 22.5 W (24 VDC)			
Weight		0.135 kg (0.30 lb)	0.170 kg (0.37 lb)	0.230 kg (0.51 lb)	0.315 kg (0.69 lb)

NOTE - For different conditions, please contact Walvoil Sales Dpt. - *For coils further features see from page 206.

Normally open configuration

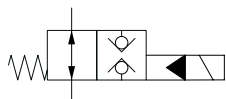

Normally closed configuration

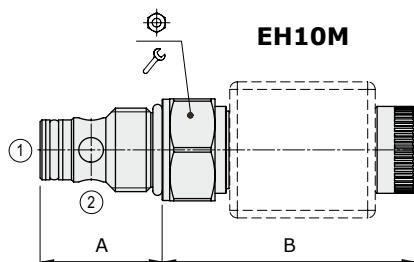
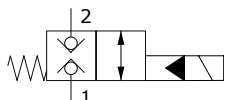

Valve type	A		B				Nm	lbft
	mm	in	mm	in				
EH08M/	10NB	28	1.10	67.2	2.64	24	30	22
	20NB	28	1.10	63.3	2.49	24	30	22
EH10M/	10NB	32.3	1.27	66.9	2.63	27	50	37
	20NB	32.3	1.27	63	2.48	27	50	37
EH12M/	10NB	45	1.77	61.1	2.40	32	80	59
	20NB	45	1.77	57.2	2.25	32	80	59
EH16M/	10NB	46	1.81	61.2	2.41	38	80	59
	20NB	46	1.81	57.3	2.26	38	80	59

For dimensions with different type of emergency see page 213

Ordering codes and description composition

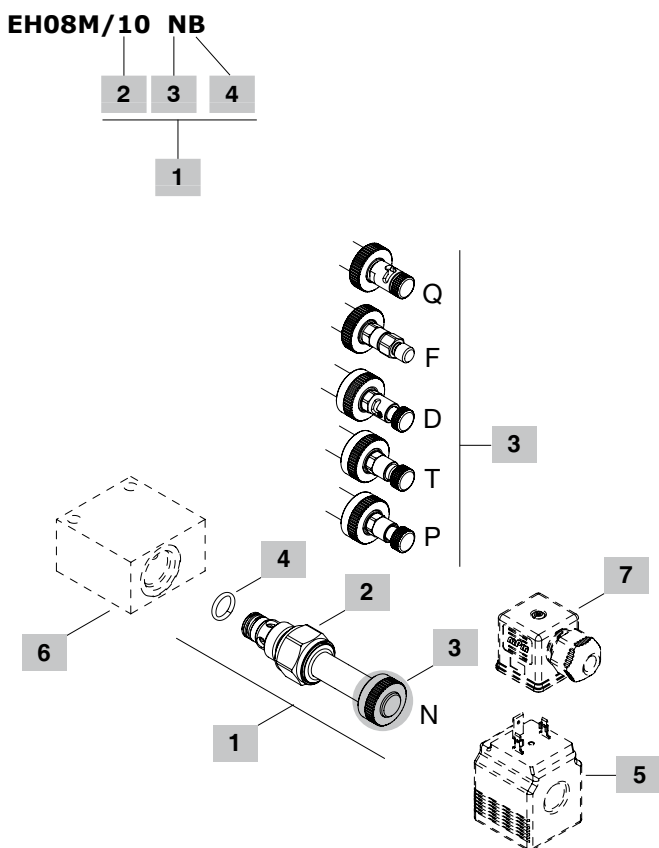

1 Cartucce

TYPE	CODE	DESCRIPTION
SAE cavity 08/2		
EH08M/10NB	0EH08002000	Normally open (N.O.) without emergency
EH08M/10PB	0EH08002002	(N.O.) push button emergency
EH08M/10TB	0EH08002003	(N.O.) screw type emergency
EH08M/10DB	0EH08002004	(N.O.) push type with detent emergency
EH08M/20NB	0EH08002001	Normally closed (N.C.) without emergency
EH08M/20FB	0EH08002005	(N.C.) pull button emergency
EH08M/20TB	0EH08002006	(N.C.) screw type emergency
EH08M/20QB	0EH08002007	(N.C.) pull type with detent emergency
SAE cavity 10/2		
EH10M/10NB	0EH10002000	Normally open (N.O.) without emergency
EH10M/10PB	0EH10002002	(N.O.) push button emergency
EH10M/10TB	0EH10002003	(N.O.) screw type emergency
EH10M/10DB	0EH10002004	(N.O.) push type with detent emergency
EH10M/20NB	0EH10002001	Normally closed (N.C.) without emergency
EH10M/20FB	0EH10002005	(N.C.) pull button emergency
EH10M/20TB	0EH10002006	(N.C.) screw type emergency
EH10M/20QB	0EH10002007	(N.C.) pull type with detent emergency
SAE cavity 12/2		
EH12M/10NB	0EH12002000	Normally open (N.O.) without emergency
EH12M/10PB	0EH12002002	(N.O.) push button emergency
EH12M/10TB	0EH12002003	(N.O.) screw type emergency
EH12M/10DB	0EH12002004	(N.O.) push type with detent emergency
EH12M/20NB	0EH12002001	Normally closed (N.C.) without emergency
EH12M/20FB	0EH12002005	(N.C.) pull button emergency
EH12M/20TB	0EH12002006	(N.C.) screw type emergency
EH12M/20QB	0EH12002007	(N.C.) pull type with detent emergency
SAE cavity 16/2		
EH16M/10NB	0EH16002000	Normally open (N.O.) without emergency
EH16M/10PB	0EH16002002	(N.O.) push button emergency
EH16M/10TB	0EH16002003	(N.O.) screw type emergency
EH16M/10DB	0EH16002004	(N.O.) push type with detent emergency
EH16M/20NB	0EH16002001	Normally closed (N.C.) without emergency
EH16M/20FB	0EH16002005	(N.C.) pull button emergency
EH16M/20TB	0EH16002006	(N.C.) screw type emergency
EH16M/20QB	0EH16002007	(N.C.) pull type with detent emergency

2 Spool

TYPE	DESCRIPTION
1	Normally open configuration
2	Normally closed configuration

3 Emergency

TYPE	DESCRIPTION
N	Without emergency
P	Push button type (N.O.)
T	Screw type
D	Push type with detent (N.O.)
F	Pull button type (N.C.)
Q	Pull type with detent (N.C.)

4 Seals

TYPE	DESCRIPTION
B	NBR (Buna) o-ring seals, std configuration
V	FPM (Viton) o-ring seals, contact Sales Dept.

5 Coils

TYPE	CODE	DESCRIPTION
BER 12VDC	4SLE001200	12VDC-ISO4400 coil

For complete coils list see from page 206

6 Valve body

TYPE	CODE	DESCRIPTION
SAE 08/2-SAE8	3CC0820K11	Aluminium body for cavity 08 valve, SAE8 std thread
SAE 10/2-SAE8	3CC1020K11	Aluminium body for cavity 10 valve, SAE8 std thread
SAE 12/2-SAE10	3CC1220L11	Aluminium body for cavity 12 valve, SAE10 std thread
SAE 16/2-SAE12	3CC1620M11	Aluminium body for cavity 16 valve, SAE12 std thread

Note: aluminium body can stand up to 210 bar (3050 psi)
For steel bodies or different threading see from page 215

7 Connector

TYPE	CODE	DESCRIPTION
ISO4400	4CN1009995	Connector

For complete connectors list see from page 206

Rating diagrams

EH08M/10NB - EH08M/20NB
 pressure drop vs. flow

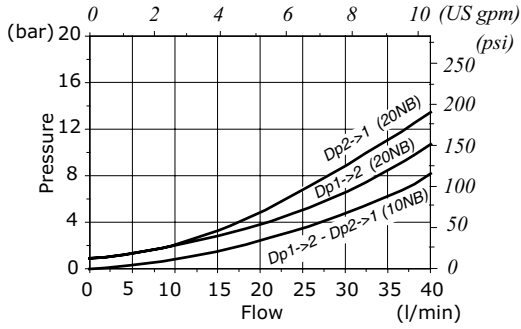

EH10M/10NB - EH10M/20NB
 pressure drop vs. flow

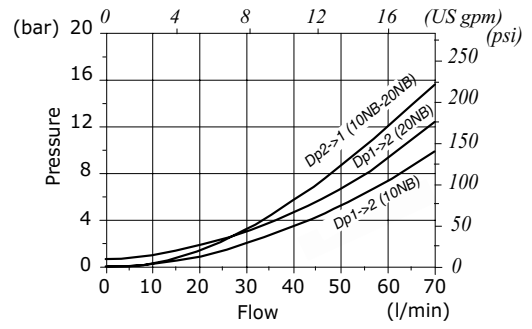

EH12M/10NB - EH12M/20NB
 pressure drop vs. flow

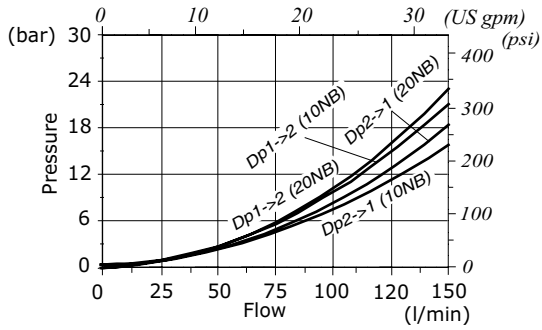

EH16M/10NB - EH16M/20NB
 pressure drop vs. flow

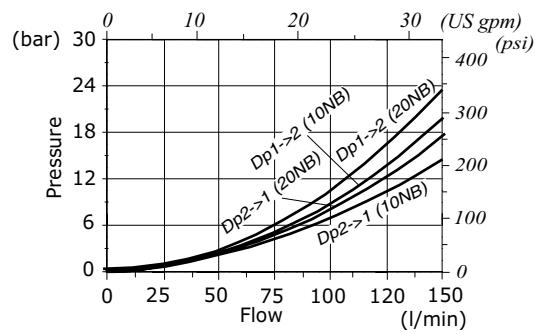



EW... type directional solenoid valves - 2 way / 2 positions

- Direct acting
- Poppet type
- Normally open and closed configurations
- With check in both directions
- From SAE08 to SAE12 cavities

Technical specifications and diagrams are measured with mineral oil of 46 cSt viscosity at 40°C (104°F) temperature.

	EW08A	EW10A-EW10B	EW12B-EW12C
Nominal flow	10 l/min (2.64 US gpm)	25-30 l/min (6.6 - 7.9 US gpm)	50 l/min (13.2 US gpm)
Max. pressure	210 bar (3050 psi)		
Oil leakage	at 210 bar (3050 psi) 0.25 cm ³ /min (0.015 in ³ /min)	0.25 cm ³ /min (0.015 in ³ /min)	0.25 cm ³ /min (0.015 in ³ /min)
Fluid	mineral based oil		
Viscosity	10-200 cSt		
Max level of contamin.	18/16/13 ISO4406		
Fluid temperature	with NBR seals with FPM seals	from -20°C (-4°F) to 80°C (176°F) from -20°C (-4°F) to 100°C (212°F)	
Environmental temp. for working conditions	from -20°C (-4°F) to 50°C (122°F)		
Cavity	SAE 08/2	SAE 10/2	SAE 12/2
Coil type*	BT	BIN 19	BIN 22
Nominal voltages	12 VDC - 24 VDC ± 10%		
Power rating	21 W	29 W (12 VDC) - 31 W (24 VDC)	32.6 W (12 VDC) - 31 W (24 VDC)
Weight	0.16 kg (0.35 lb)	0.25 kg (0.55 lb)	0.44 kg (0.97 lb)

NOTE - For different conditions, please contact Walvoil Sales Dpt. - *For coils further features see from page 206.

Normally open configuration

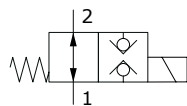

Normally closed configuration

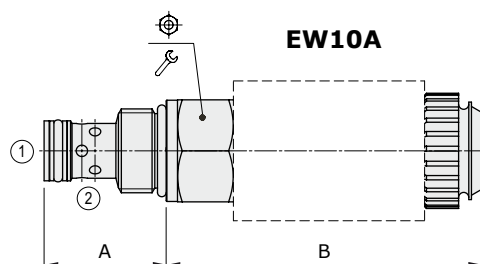
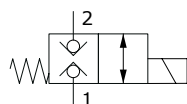

Valve type	A		B		⊕	⊖	Nm	lbft
	mm	in	mm	in				
EW08A/10NB	28.5	1.12	65.7	2.59	24	30	22	
EW08A/20NB	28.5	1.12	70.9	2.79	24	30	22	
EW10A/20PB	32.3	1.27	83.3	3.28	27	50	37	
EW10B/10NB	32.3	1.27	99.8	3.93	27	50	37	
EW12C/20PB	46	1.81	98.7	3.89	32	80	59	
EW12B/10NB	46	1.81	102.8	4.05	32	80	59	

For dimensions with different type of emergency see page 213

Ordering codes and description composition

EW08A/10 NB

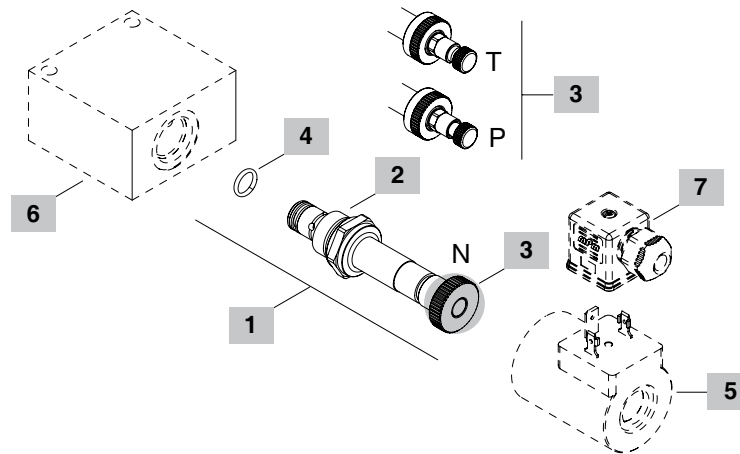
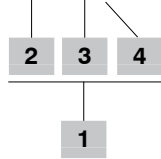

1 Cartridges

TYPE	CODE	DESCRIPTION
SAE cavity 08/2		
EW08A/10NB	0EW08002001	Normally open configuration (N.O.) without emergency
EW08A/10TB	0EW08002003	Normally open configuration (N.O.) with screw type emergency
EW08A/20NB	0EW08002006	Normally closed configuration (N.C.) Without emergency
EW08A/20PB	0EW08002004	Normally closed configuration (N.C.) with push button emergency
EW08A/20TB	0EW08002002	Normally open configuration (N.C.) with screw type emergency
SAE cavity 10/2		
EW10B/10NB	0EW10002004	Normally open configuration (N.O.) without emergency
EW10A/20PB	0EW10002002	Normally closed configuration (N.C.) with push button emergency
SAE cavity 12/2		
EW12B/10NB	0EW12002005	Normally open configuration (N.O.) without emergency
EW12C/20PB	0EW12002003	Normally closed configuration (N.C.) with push button emergency

2 Spool

TYPE	DESCRIPTION
1	Normally open configuration
2	Normally closed configuration

3 Emergency

TYPE	DESCRIPTION
N	Without emergency
T	Screw type
P	Push button type (N.C.)

Note: emergency type depends on cavity type. See chapter 4 for availability.

4 Seals

TYPE	DESCRIPTION
B	NBR (Buna) o-ring seals, std configuration
V	FPM (Viton) o-ring seals, contact Sales Dept.

5 Coils

TYPE	CODE	DESCRIPTION
BT 12VDC	4SL3000120	12VDC-ISO4400 coil for EW08A
BIN 19 VDC	4SL6000121	12VDC-ISO4400 coil for EW10A-EW10B
BIN 22 VDC	4SL6000128	12VDC-ISO4400 coil for EW12A-EW12C

For complete coils list see from page 206

6 Valve body

TYPE	CODE	DESCRIPTION
SAE 08/2-SAE8	3CC0820K11	Aluminium body for cavity 08 valve, SAE8 std thread
SAE 10/2-SAE8	3CC1020K11	Aluminium body for cavity 10 valve, SAE8 std thread
SAE 12/2-SAE10	3CC1220L11	Aluminium body for cavity 12 valve, SAE10 std thread

For steel bodies or different threading see from page 215

7 Connector

TYPE	CODE	DESCRIPTION
ISO4400	4CN1009995	Connector

For complete connectors list see from page 206

Rating diagrams

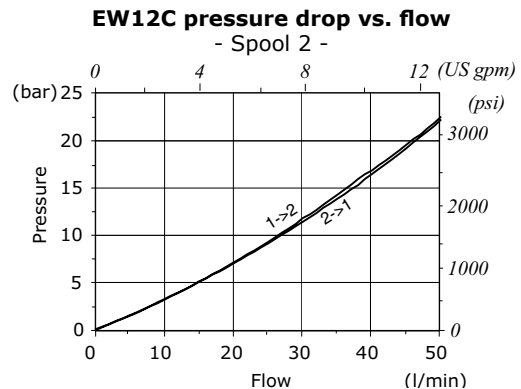
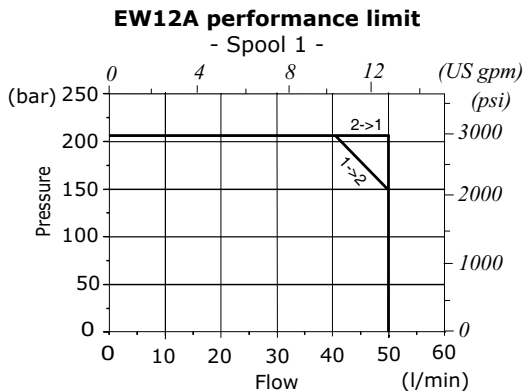
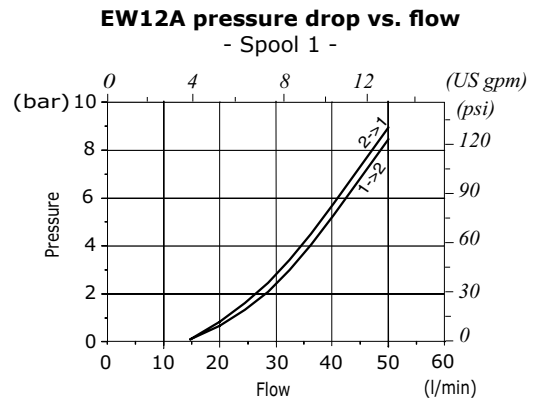
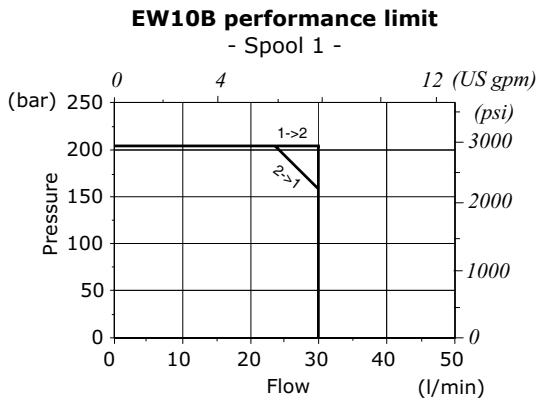
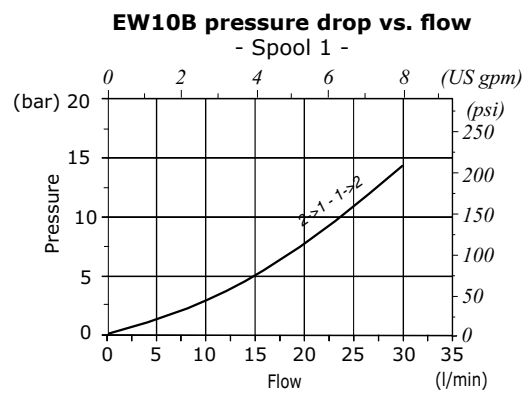
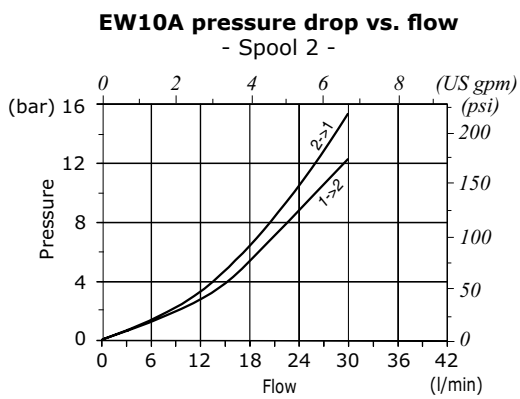
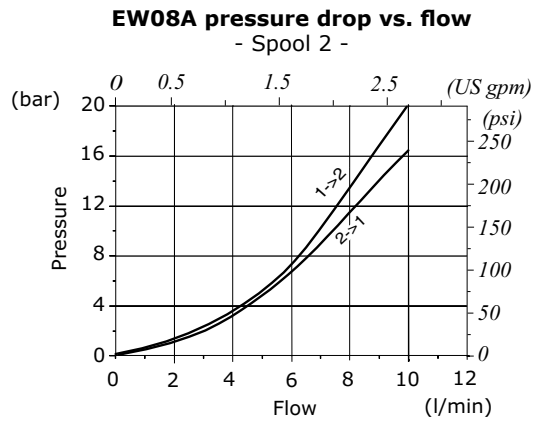
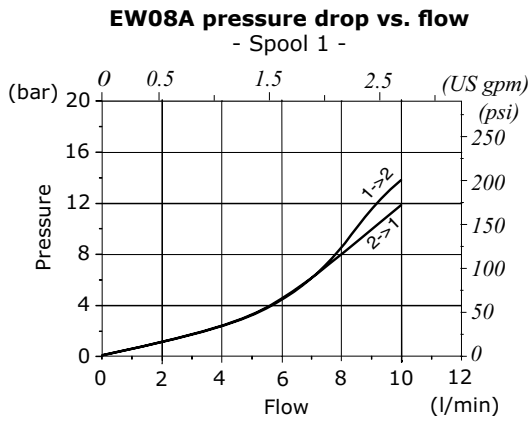



EW..M type directional solenoid valves - 2 way / 2 positions

- Direct acting
- Poppet type
- Normally open and closed configurations
- With check in both directions
- From SAE08 to SAE10 cavities

Technical specifications and diagrams are measured with mineral oil of 46 cSt viscosity at 40°C (104°F) temperature.

	EW08M	EW10M
Nominal flow	20 l/min (5.28 US gpm)	40 l/min (10.6 US gpm)
Max. pressure	250 bar (3600 psi)	350 bar (5075 psi)
Oil leakage	at 210 bar (3050 psi) 0.25 cm ³ /min (0.015 in ³ /min)	0.25 cm ³ /min (0.015 in ³ /min)
Fluid	mineral based oil	
Viscosity	10-200 cSt	
Max level of contamination	18/16/13 ISO4406	
Fluid temperature	with NBR seals with FPM seals	from -20°C (-4°F) to 80°C (176°F) from -20°C (-4°F) to 100°C (212°F)
Environmental temp. for working conditions	from -20°C (-4°F) to 50°C (122°F)	
Cavity	SAE 08/2	SAE 10/2
Coil type*	BER	BH
Nominal voltages	12 VDC - 24 VDC ± 10%	
Power rating	22.8 W (12 VDC) - 22.5 W (24 VDC)	33 W
Weight	0.15 kg (0.33 lb)	0.30 kg (0.66 lb)

NOTE - For different conditions, please contact Walvoil Sales Dpt. - *For coils further features see from page 206.

Normally open configuration

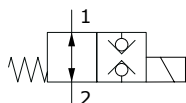

Normally closed configuration

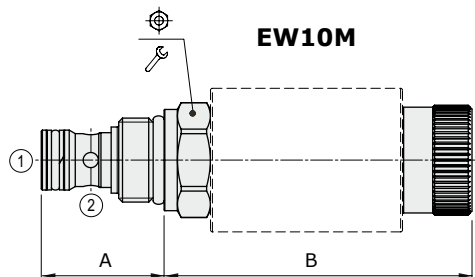
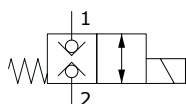

Valve type	A		B				Nm	lbft
	mm	in	mm	in				
EW08M/10NB	28	1.10	60.2	2.37	24	30	22	
EW08M/20NB	28	1.10	62.5	2.46	24	30	22	
EW10M/20NB	32.5	1.28	81.3	3.20	27	50	37	

For dimensions with different type of emergency see page 213

Ordering codes and description composition

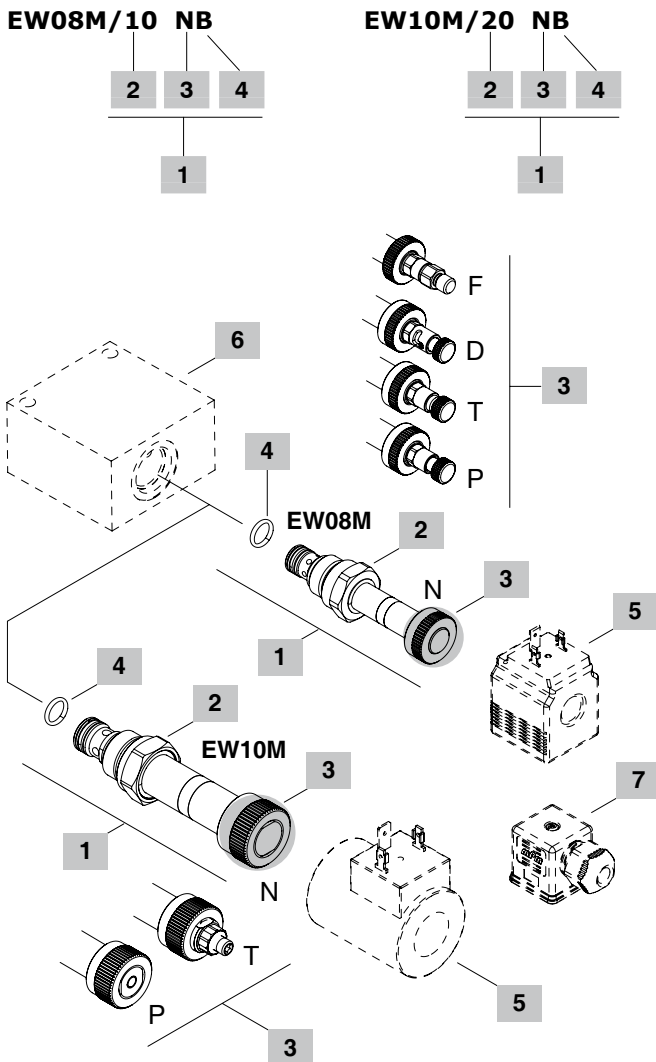

1 Cartridges

TYPE	CODE	DESCRIPTION
SAE cavity 08/2		
EW08M/10NB	0EW08002014	Normally open (N.O.) without emergency
EW08M/10FB	0EW08002015	(N.O.) pull button emergency
EW08M/10TB	0EW08002016	(N.O.) screw type emergency
EW08M/20NB	0EW08002018	Normally closed (N.C.) without emergency
EW08M/20PB	0EW08002019	(N.C.) push button emergency
EW08M/20TB	0EW08002020	(N.C.) screw type emergency
EW08M/20DB	0EW08002021	(N.C.) push type with detent emergency
SAE cavity 10/2		
EW10M/20NB	0EW10002008	Normally closed (N.C.) without emergency
EW10M/20TB	0EW10002009	(N.C.) screw type emergency
EW10M/20PB	0EW10002010	(N.C.) push button emergency

2 Spool

TIPO	DESCRIZIONE
1	Configurazione normalmente aperta
2	Configurazione normalmente chiusa

3 Emergency

TYPE	DESCRIPTION
N	Without emergency
P	Push button type (N.C.)
T	Screw type (N.C. - N.O. for EW08M / N.C. for EW10M)
D	Push type with detent (N.C.)
F	Pull button type (N.O.)

4 Seals

TYPE	DESCRIPTION
B	NBR (Buna) o-ring seals, std configuration
V	FPM (Viton) o-ring seals, contact Sales Dept.

5 Coils

TYPE	CODE	DESCRIPTION
BER 12VDC	4SLE001200	12VDC-ISO4400 coil for EW08M
BH 12VDC	4SLD001200	12VDC-ISO4400 coil for EW10M

For complete coils list see from page 206

6 Valve body

TYPE	CODE	DESCRIPTION
SAE 08/2-SAE8	3CC0820K11	Aluminium body for cavity 08 valve, SAE8 std thread
SAE 10/2-SAE8	3CC1020K11	Aluminium body for cavity 10 valve, SAE8 std thread

Note: aluminium body can stand up to 210 bar (3050 psi)
For steel bodies or different threading see from page 215

7 Connector

TYPE	CODE	DESCRIPTION
ISO4400	4CN1009995	Connector

For complete connectors list see from page 206

Rating diagrams

EW08M pressure drop vs. flow

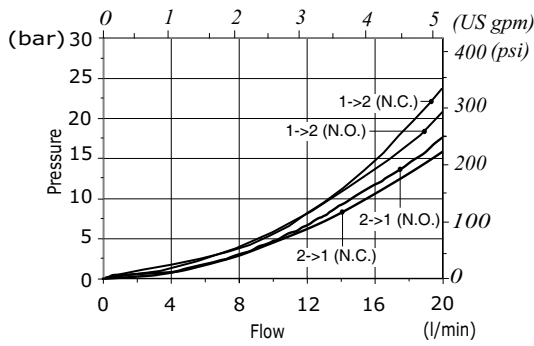

EW10M pressure drop vs. flow (N.C.)

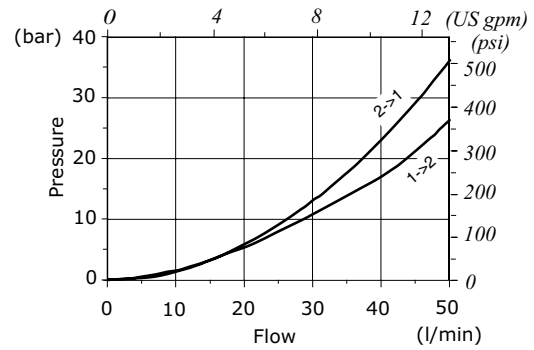

EW08M performance limit (N.O.)

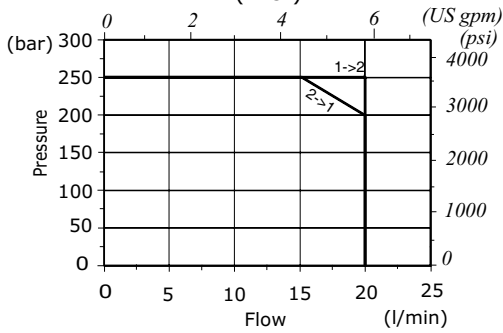

EW08M performance limit (N.C.)

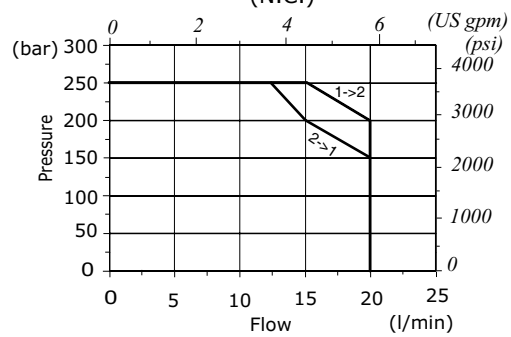

EW10M performance limit (N.C.)

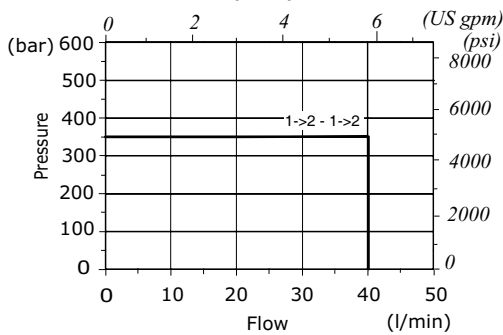



EJ08F type directional solenoid valve - 3 way / 2 positions

- Direct acting
- Spool type
- Suitable for low pressure: 50 bar (725 psi)

Technical specifications and diagrams are measured with mineral oil of 46 cSt viscosity at 40°C (104°F) temperature.

		EJ08F
Nominal flow		12 l/min (3.17 US gpm)
Max. pressure		50 bar (725 psi)
Oil leakage	at 50 bar (725 psi)	5 cm ³ /min (0.30 in ³ /min)
Fluid		mineral based oil
Viscosity		10-200 cSt
Max level of contamination		18/16/13 ISO4406
Fluid temperature	<i>with NBR seals</i>	from -20°C (-4°F) to 80°C (176°F)
	<i>with FPM seals</i>	from -20°C (-4°F) to 100°C (212°F)
Environmental temp. for working conditions		from -20°C (-4°F) to 50°C (122°F)
Cavity		SAE 08/3
Coil type*		BT
Nominal voltages		12 VDC - 24 VDC ± 10%
Power rating		21 W
Weight		0.175 kg (0.38 lb)

NOTE - For different conditions, please contact Walvoil Sales Dpt. - *For coils further features see from page 206.

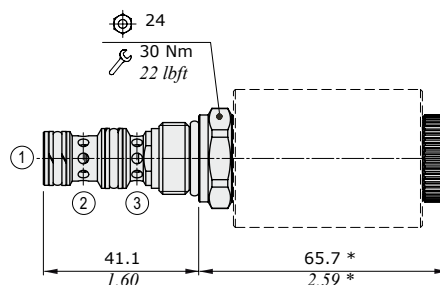
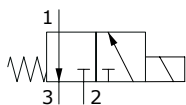

NOTE (*): dimension for configuration **EJ08F/20NB**, for dimensions with different type of emergency see page 213.

Ordering codes and description composition

EJ08F/20 NB

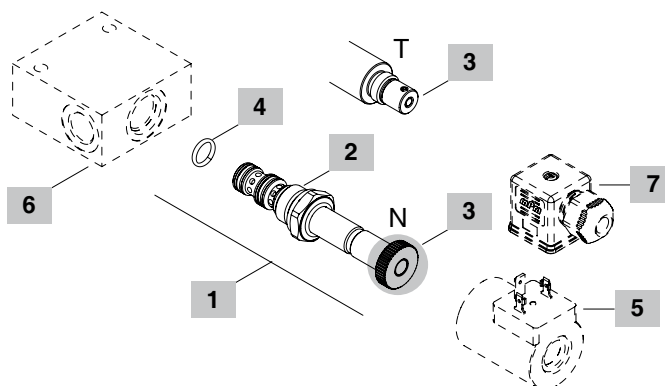
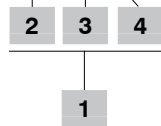

1 Cartridges

TYPE	CODE	DESCRIPTION
SAE cavity 08/3		
EJ08F/20NB	0EJ08002029	Without emergency
EJ08F/20TB	0EJ08002043	Screw type emergency

2 Spool

TYPE	DESCRIPTION
2	Spool 2

3 Emergency

TYPE	DESCRIPTION
N	Without emergency
T	Screw type

4 Seals

TYPE	DESCRIPTION
B	NBR (Buna) o-ring seals, std configuration
V	FPM (Viton) o-ring seals, contact Sales Dept.

5 Coils

TYPE	CODE	DESCRIPTION
BT 12VDC	4SL3000120	12VDC-ISO4400 coil

For complete coils list see from page 206

6 Valve body

TYPE	CODE	DESCRIPTION
SAE 08/3-SAE6	3CC0830J11	Aluminium body for cavity 08 valve, SAE6 std thread

For steel bodies or different threading see from page 217

7 Connector

TYPE	CODE	DESCRIPTION
ISO4400	4CN1009995	Connector

For complete connectors list see from page 206

Rating diagrams

Pressure drop vs. flow

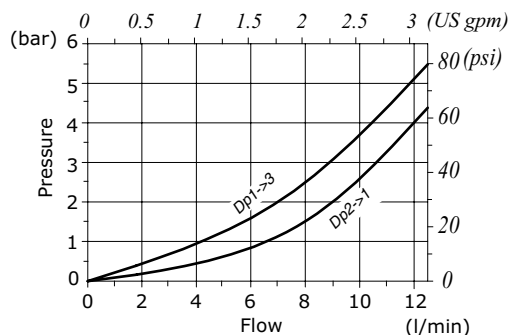



EJ8CA type directional solenoid valve - 3 way / 2 positions

- Direct acting
- Spool type
- Suitable for low pressure: 70 bar (1015 psi)
- SAE 08/3C cavity

Technical specifications and diagrams are measured with mineral oil of 46 cSt viscosity at 40°C (104°F) temperature.

		EJ8CA
Nominal flow		10 l/min (2.64 US gpm)
Max. pressure		70 bar (1015 psi)
Oil leakage	at 70 bar (1015 psi)	20 cm ³ /min (1.22 in ³ /min)
Fluid		olio a base minerale
Viscosity		10-200 cSt
Max level of contamination		18/16/13 ISO4406
Fluid temperature	<i>with NBR seals</i>	from -20°C (-4°F) to 80°C (176°F)
	<i>with FPM seals</i>	from -20°C (-4°F) to 100°C (212°F)
Environmental temp. for working conditions		from -20°C (-4°F) to 50°C (122°F)
Cavity		SAE 08/3C
Coil type (¹)		BER
Nominal voltages		12 VDC - 24 VDC ± 10%
Power rating		22.8 W (12 VDC) - 22.5 W (24 VDC)
Weight		0.116 kg (0.26 lb)

NOTE - For different conditions, please contact Walvoil Sales Dpt. - (¹) For coils further features see from page 206.

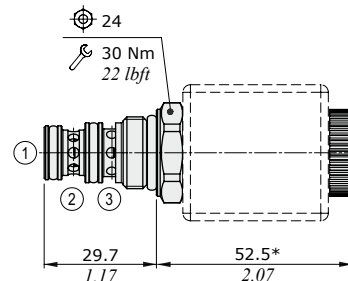
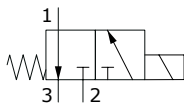

NOTE (*): dimension for configuration **EJ8CA/20NB**, for dimensions with different type of emergency see page 213.

Ordering codes and description composition

EJ8CA/20 NB

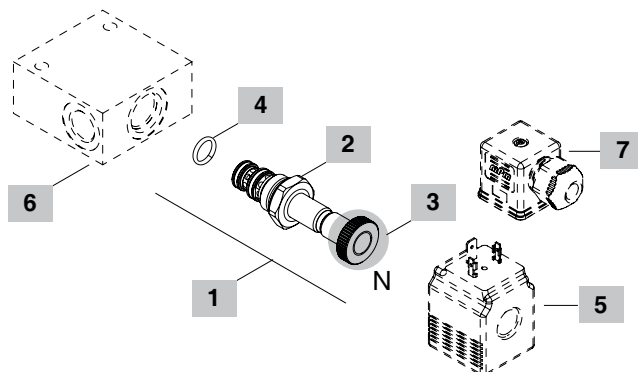
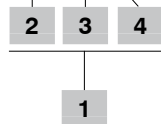

1 Cartridges

TYPE	CODE	DESCRIPTION
SAE cavity 08/3C		
EJ8CA/20NB	0EJ8C002000	Without emergency

2 Spool

TYPE	DESCRIPTION
2	Spool 2

3 Emergency

TYPE	DESCRIPTION
N	Without emergency

4 Seals

TYPE	DESCRIPTION
B	NBR (Buna) o-ring seals, std configuration
V	FPM (Viton) o-ring seals, contact Sales Dept.

5 Coils

TYPE	CODE	DESCRIPTION
BER 12VDC		
4SLE001200	12VDC-ISO4400 coil	

For complete coils list see from page 206

6 Valve body

TYPE	CODE	DESCRIPTION
SAE 08/3C-G 3/8		
3CC0833C11	Aluminium body for cavity 08C valve, G3/8 std thread	

For steel bodies or different threading see from page 217

7 Connector

TYPE	CODE	DESCRIPTION
ISO4400		
4CN1009995	Connector	

For complete connectors list see from page 206

Rating diagrams

Pressure drop vs. flow

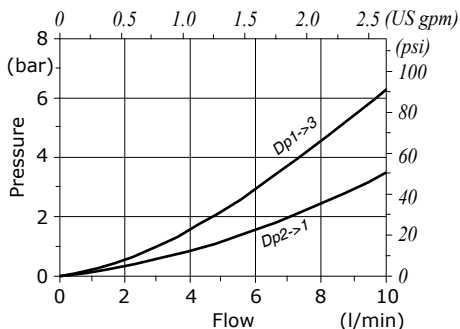

Performance limit

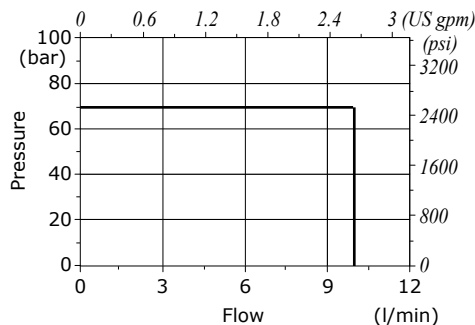



EJ08G type directional solenoid valve - 3 way / 2 positions

- Direct acting
- Spool type
- Suitable for high pressure: 350 bar (5100 psi)

Technical specifications and diagrams are measured with mineral oil of 46 cSt viscosity at 40°C (104°F) temperature.

EJ08G

Nominal flow		3 l/min (0.80 US gpm)
Max. pressure		350 bar (5100 psi)
Oil leakage	at 210 bar (3050 psi)	10 cm ³ /min (0.61 in ³ /min)
Fluid		mineral based oil
Viscosity		10-200 cSt
Max level of contamination		18/16/13 ISO4406
Fluid temperature	with NBR seals	from -20°C (-4°F) to 80°C (176°F)
	with FPM seals	from -20°C (-4°F) to 100°C (212°F)
Environmental temp. for working conditions		from -20°C (-4°F) to 50°C (122°F)
Cavity		SAE 08/3
Coil type*		BT
Nominal voltages		12 VDC - 24 VDC ± 10%
Power rating		21 W
Weight		0.134 kg (0.29 lb)

NOTE - For different conditions, please contact Walvoil Sales Dpt. - *For coils further features see from page 206.

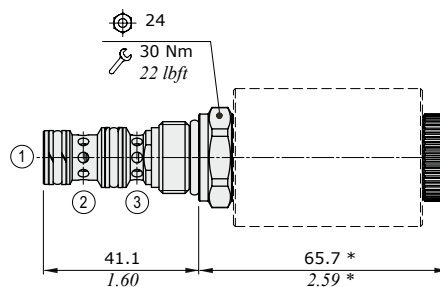
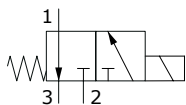

NOTE (*): dimension for configuration **EJ08G/20NB**, for dimensions with different type of emergency see page 213.

Ordering codes and description composition

EJ08G/20 NB

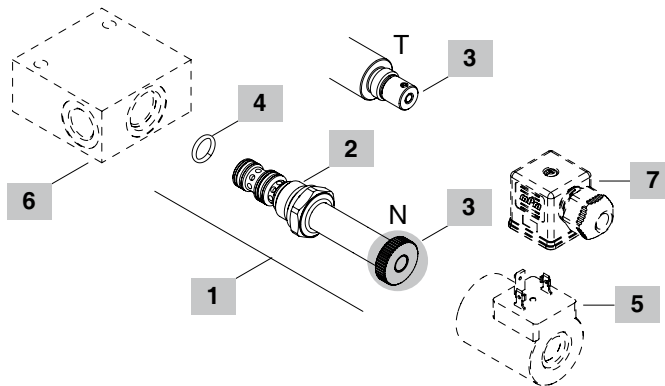
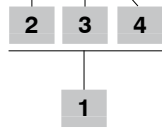

1 Cartridges

TYPE	CODE	DESCRIPTION
SAE cavity 08/3		
EJ08G/20NB	0EJ08002035	Without emergency
EJ08G/20TB	0EJ08002042	Screw type emergency

2 Spool

TYPE	DESCRIPTION
2	Spool 2

3 Emergency

TYPE	DESCRIPTION
N	Without emergency
T	Screw type

4 Seals

TYPE	DESCRIPTION
B	NBR (Buna) o-ring seals, std configuration
V	FPM (Viton) o-ring seals, contact Sales Dept.

5 Coils

TYPE	CODE	DESCRIPTION
BT 12VDC	4SL3000120	12VDC-ISO4400 coil

For complete coils list see from page 206

6 Valve body

TYPE	CODE	DESCRIPTION
SAE 08/3-SAE6	3CC0830J11	Aluminium body for cavity 08 valve, SAE6 std thread

Note: aluminium body can stand up to 210 bar (3050 psi)
For steel bodies or different threading see from page 217

7 Connector

TYPE	CODE	DESCRIPTION
ISO4400	4CN1009995	Connector

For complete connectors list see from page 206

Rating diagrams

Pressure drop vs. flow

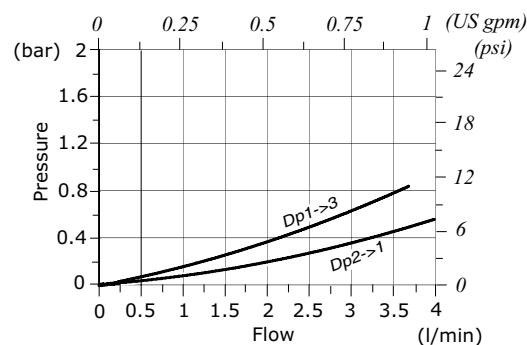



EJ..M type directional solenoid valve - 3 way / 2 positions

- Direct acting
- Spool type
- From SAE08 to SAE10 cavities

Technical specifications and diagrams are measured with mineral oil of 46 cSt viscosity at 40°C (104°F) temperature.

	EJ08M	EJ10M
Nominal flow	25 l/min (6.6 US gpm)	40 l/min (10.5 US gpm)
Max. pressure	250 bar (3600 psi)	250 bar (3600 psi)
Oil leakage	at 210 bar (3050 psi) 40 cm ³ /min (2.44 in ³ /min)	80 cm ³ /min (4.88 in ³ /min)
Fluid	mineral based oil	
Viscosity	10-200 cSt	
Max level of contamination	18/16/13 ISO4406	
Fluid temperature	with NBR seals with FPM seals	from -20°C (-4°F) to 80°C (176°F) from -20°C (-4°F) to 100°C (212°F)
Environmental temp. for working conditions	from -20°C (-4°F) to 50°C (122°F)	
Cavity	SAE 08/3	SAE 10/3
Coils type*	BER	BC16
Nominal voltages	12 VDC - 24 VDC ± 10%	12 VDC - 24 VDC ± 10%
Power rating	22.8 W (12 VDC) - 22.5 W (24 VDC)	26.1 W (12 VDC) - 25.9 W (24 VDC)
Weight	0.125 kg (0.27 lb)	0.300 kg (0.661 lb)

NOTE - For different conditions, please contact Walvoil Sales Dpt. - *For coils further features see from page 206.

Spool 1

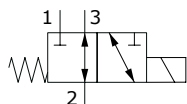

Spool 2

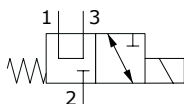

Spool 3 (only EJ08M)

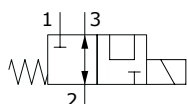

Spool 4

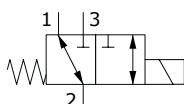

Spool 5

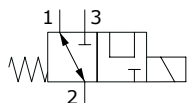

Spool 6 (only EJ10M)

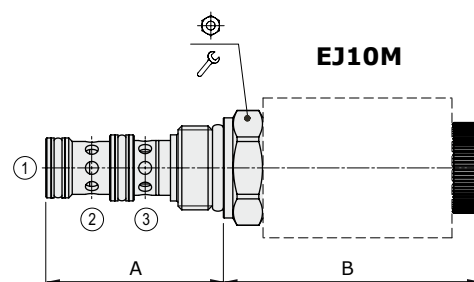
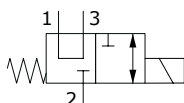

Valve type	A		B		⊕	⚙	Nm	lbft
	mm	in	mm	in				
EJ08M/10NB	41.1	1.62	56.1	2.21	24	30	22	
EJ10M/10NB	47	1.85	68	2.68	27	50	37	

For dimensions with different type of emergency see page 213

Ordering codes and description composition

EJ08M/10 NB

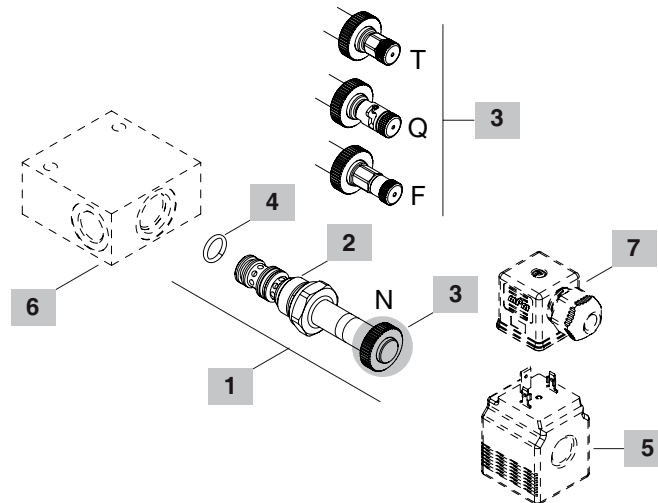
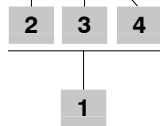

1 Cartridges

TYPE	CODE	DESCRIPTION
SAE cavity 08/3		
EJ08M/10NB	0EJ08002030	Without emergency, spool 1
EJ08M/20NB	0EJ08002031	Without emergency, spool 2
EJ08M/30NB	0EJ08002032	Without emergency, spool 3
EJ08M/40NB	0EJ08002033	Without emergency, spool 4
EJ08M/50NB	0EJ08002034	Without emergency, spool 5
SAE cavity 10/3		
EJ10M/10NB	0EJ10002018	Without emergency, spool 1
EJ10M/20NB	0EJ10002019	Without emergency, spool 2
EJ10M/40NB	0EJ10002021	Without emergency, spool 4
EJ10M/50NB	0EJ10002022	Without emergency, spool 5
EJ10M/60NB	0EJ10002023	Without emergency, spool 6

1 Spool

TYPE	DESCRIPTION
1	Spool 1
2	Spool 2
3	Spool 3
4	Spool 4
5	Spool 5
6	Spool 6

3 Emergency

TYPE	DESCRIPTION
N	Without emergency
F	Pull button type
Q	Pull type with detent
T	Screw type

4 Seals

TYPE	DESCRIPTION
B	NBR (Buna) o-ring seals, std configuration
V	FPM (Viton) o-ring seals, contact Sales Dept.

5 Coils

TYPE	CODE	DESCRIPTION
BER 12VDC	4SLE001200	12VDC-ISO4400 coil for EJ08M
BC 12VDC	4SL8000120	12VDC-ISO4400 coil for EJ10M

For complete coils list see from page 206

6 Valve body

TYPE	CODE	DESCRIPTION
SAE 08/3-SAE8	3CC0830K11	Aluminium body for cavity 08 valve, SAE8 std thread
SAE 10/3-SAE8	3CC1030K11	Aluminium body for cavity 10 valve, SAE8 std thread

Note: aluminium body can stand up to 210 bar (3050 psi)
For steel bodies or different threading see from page 217

7 Connector

TYPE	CODE	DESCRIPTION
ISO4400	4CN1009995	Connector

For complete connectors list see from page 206

Rating diagrams

EJ08M performance limit
 - Spool 1 -

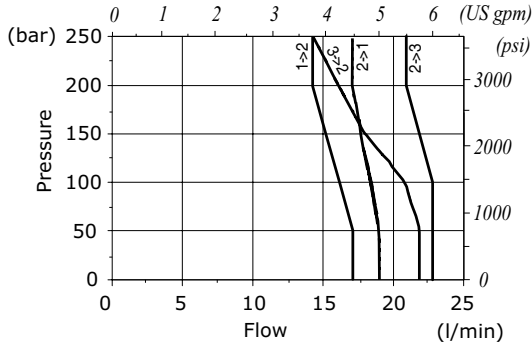

EJ08M pressure drop vs. flow
 - Spool 1 -

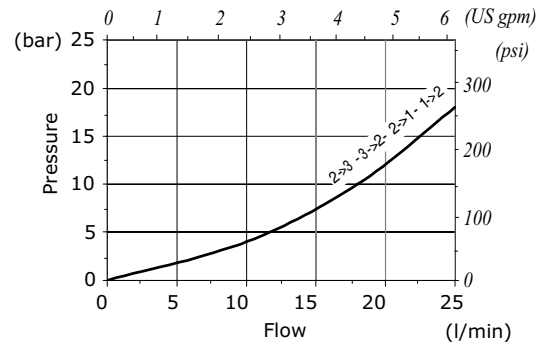

EJ08M performance limit
 - Spool 2 -

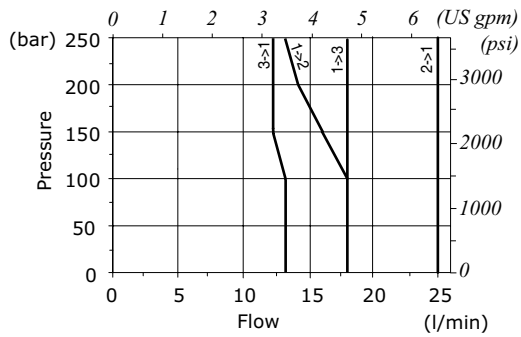

EJ08M pressure drop vs. flow
 - Spool 2 -

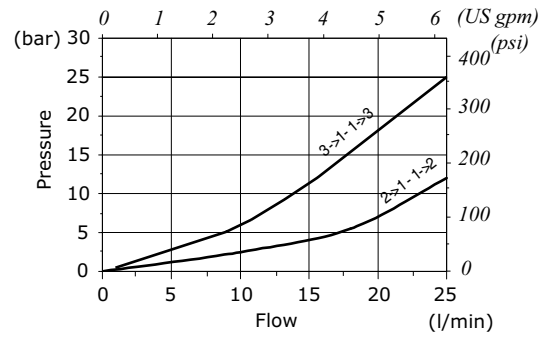

EJ08M performance limit
 - Spool 3 -

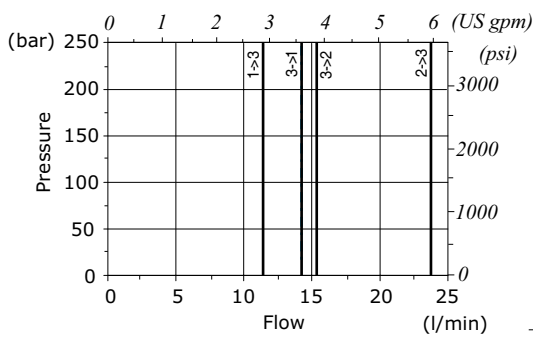

EJ08M pressure drop vs. flow
 - Spool 3 -

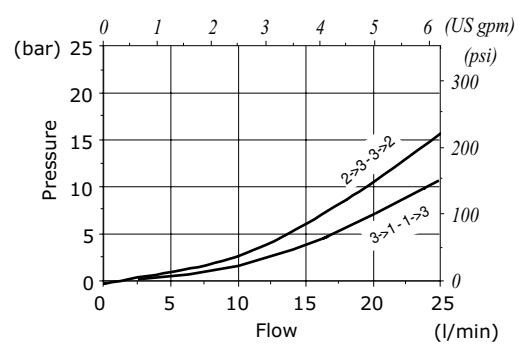

EJ08M performance limit
 - Spool 4 -

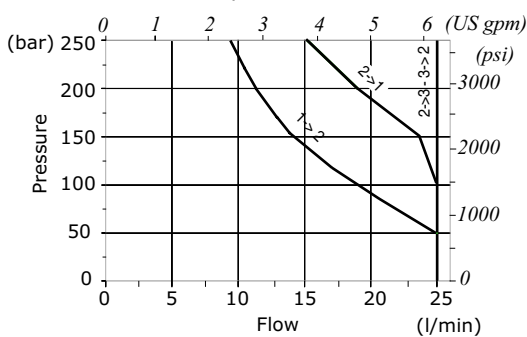

EJ08M pressure drop vs. flow
 - Spool 4 -

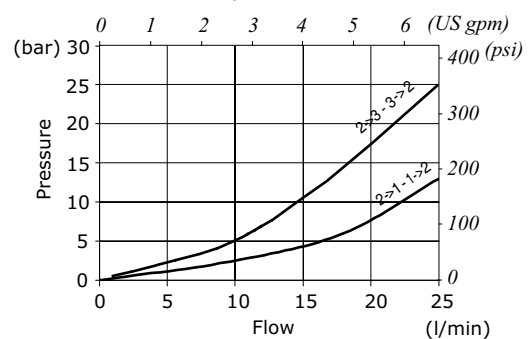

Rating diagrams

EJ08M performance limit
- Spool 5 -

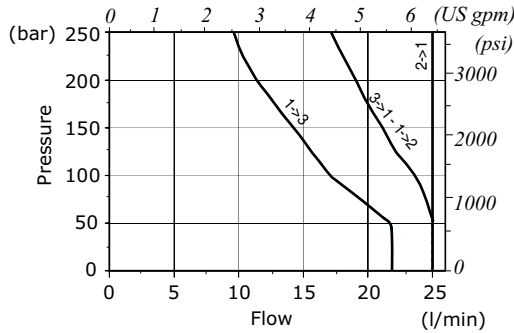

EJ08M pressure drop vs. flow
- Spool 5 -

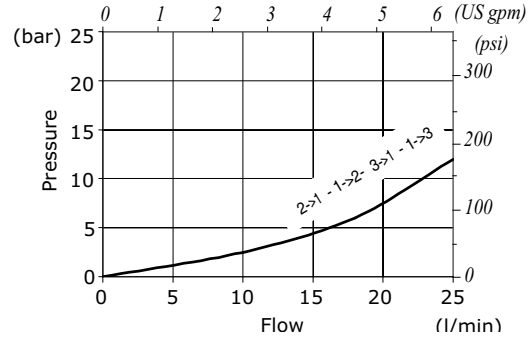

EJ10M performance limit
- Spool 1 -

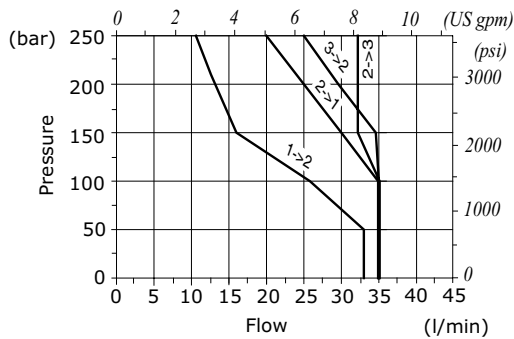

EJ10Mp pressure drop vs. flow
- Spool 1 -

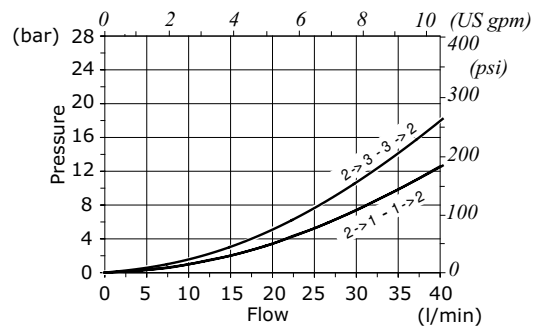

EJ10M performance limit
- Spool 2 -

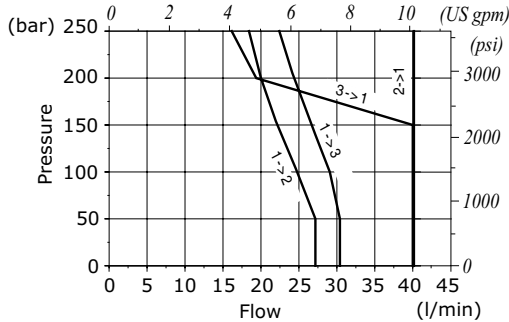

EJ10M pressure drop vs. flow
- Spool 2 -

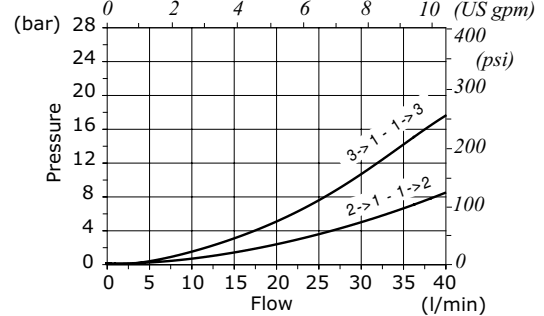

EJ10M performance limit
- Spool 4 -

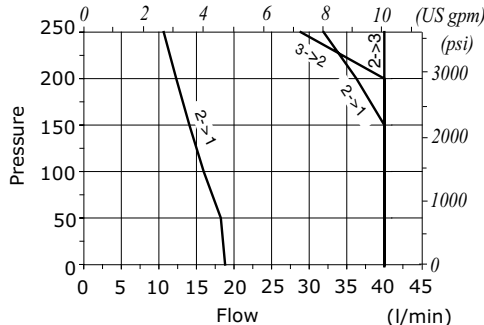

EJ10M pressure drop vs. flow
- Spool 4 -

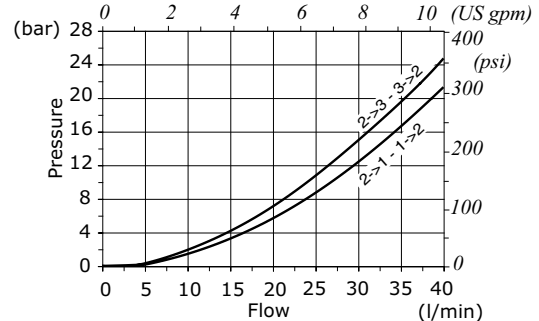

Rating diagrams

EJ10M performance limit
 - Spool 5 -

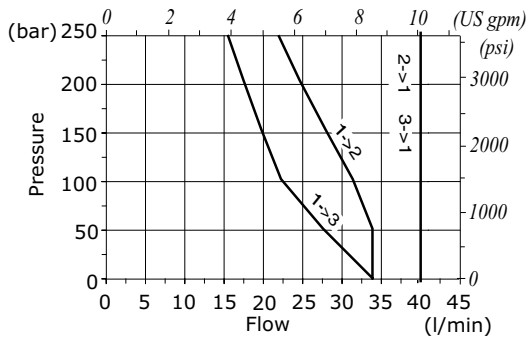

EJ10M pressure drop vs. flow
 - Spool 5 -

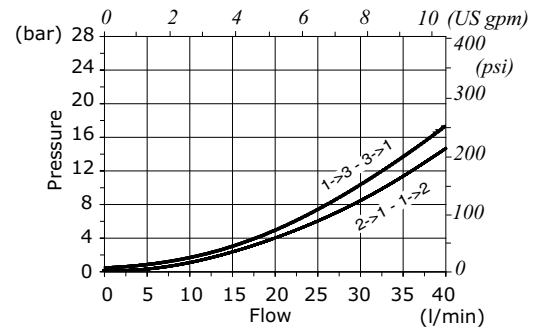

EJ10M performance limit
 - Spool 6 -

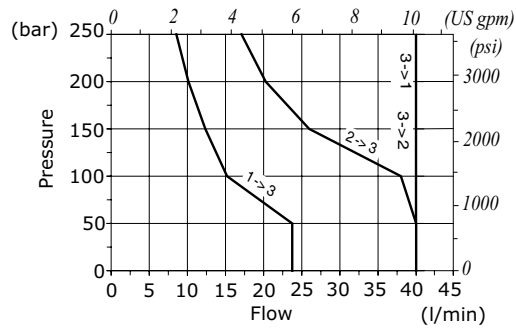

EJ10M pressure drop vs. flow
 - Spool 6 -

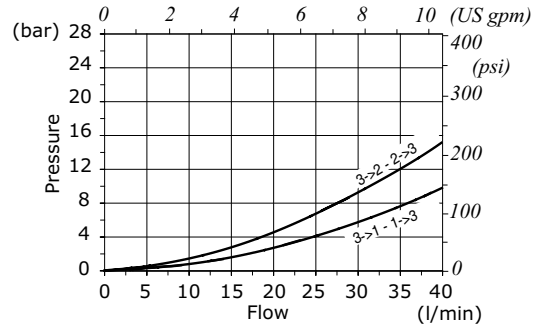



EJ12A type directional solenoid valve - 3 way / 2 positions

- Direct acting
- Spool type

Technical specifications and diagrams are measured with mineral oil of 46 cSt viscosity at 40°C (104°F) temperature.

EJ12A		
Nominal flow		40 l/min (10.5 US gpm)
Max. pressure		210 bar (3050 psi)
Oil leakage	at 210 bar (3050 psi)	120 cm ³ /min (7.32 in ³ /min)
Fluid		mineral based oil
Viscosity		10-200 cSt
Max level of contamination		18/16/13 ISO4406
Fluid temperature	with NBR seals	from -20°C (-4°F) to 80°C (176°F)
	with FPM seals	from -20°C (-4°F) to 100°C (212°F)
Environmental temp. for working conditions		from -20°C (-4°F) to 50°C (122°F)
Cavity		SAE 12/3
Coil type*		BIN 22
Nominal voltages		12 VDC - 24 VDC ± 10%
Power rating		32.6 W (12 VDC) - 31 W (24 VDC)
Weight		0.500 kg (1.10 lb)

NOTE - For different conditions, please contact Walvoil Sales Dpt. - *For coils further features see from page 206.

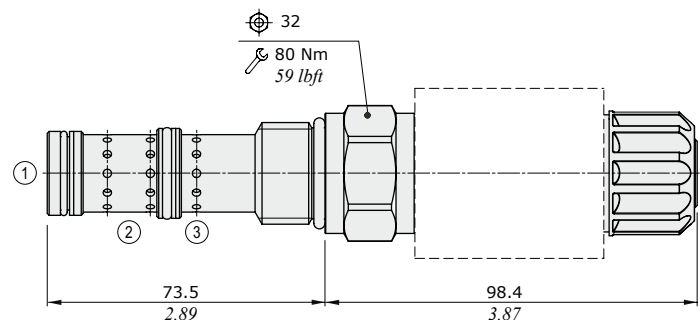
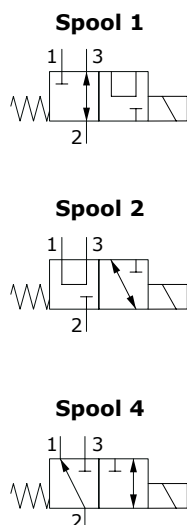

Ordering codes and description composition

EJ12A/10 PB

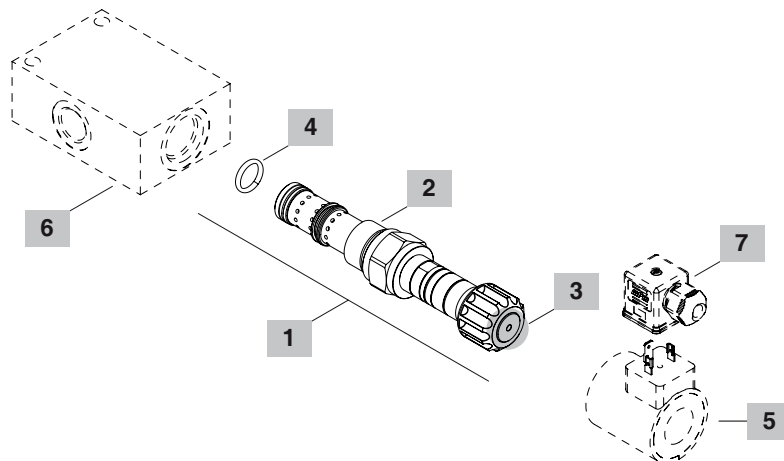
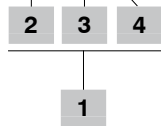

1 Cartridges

TYPE	CODE	DESCRIPTION
SAE cavity 12/3		
EJ12A/10PB	0EJ12002005	Push button emergency, spool 1
EJ12A/20PB	0EJ12002006	Push button emergency, spool 2
EJ12A/40PB	0EJ12002008	Push button emergency, spool 4

2 Spool

TYPE	DESCRIPTION
1	Spool 1
2	Spool 2
4	Spool 4

3 Emergency

TYPE	DESCRIPTION
P	Push button type

4 Seals

TYPE	DESCRIPTION
B	NBR (Buna) o-ring seals, std configuration
V	FPM (Viton) o-ring seals, contact Sales Dept.

5 Coils

TYPE	CODE	DESCRIPTION
BIN22 12VDC	4SL6000128	12VDC-ISO4400 Coil

For complete coils list see from page 206

6 Valve body

TYPE	CODE	DESCRIPTION
SAE 12/3-SAE10	3CC1230L11	Aluminium body for cavity 12 valve, SAE10 std thread

For steel bodies or different threading see from page 217

7 Connector

TYPE	CODE	DESCRIPTION
ISO4400	4CN1009995	Connector

For complete connectors list see from page 206

Rating diagrams

Pressure drop vs. flow
 - Spool 1 -

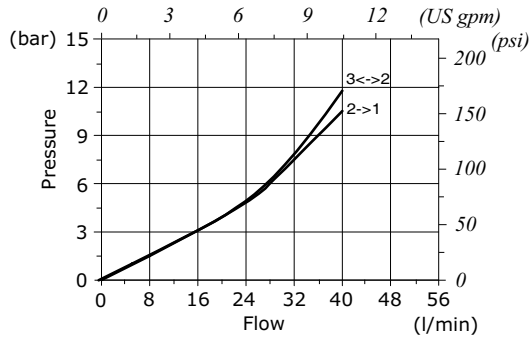

Pressure drop vs. flow
 - Spool 2 -

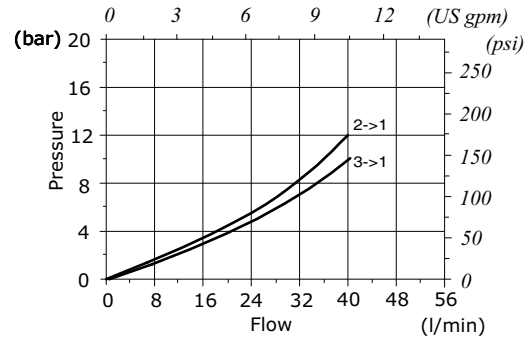

Pressure drop vs. flow
 - Spool 4 -

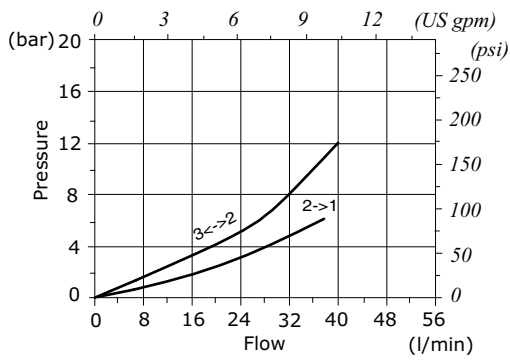

Performance limit
 - Spool 4 -

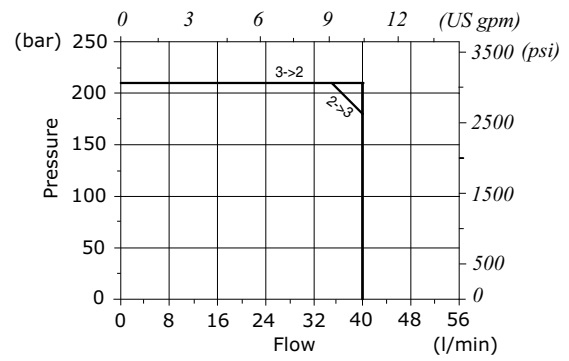



EL... type directional solenoid valve - 3 way / 2 positions

- Direct acting
- Poppet type
- From SAE08 to SAE10 cavities

Technical specifications and diagrams are measured with mineral oil of 46 cSt viscosity at 40°C (104°F) temperature.

	EL08A	EL10C
Nominal flow	10 l/min (2.64 US gpm)	20 l/min (5.28 US gpm)
Max. pressure	210 bar (3050 psi)	
Oil leakage	at 210 bar (3050 psi) 0.25 cm ³ /min (0.015 in ³ /min)	
Fluid	mineral based oil	
Viscosity	10-200 cSt	
Max level of contamination	18/16/13 ISO4406	
Fluid temperature	with NBR seals with FPM seals	from -20°C (-4°F) to 80°C (176°F) from -20°C (-4°F) to 100°C (212°F)
Environmental temp. for working conditions	from -20°C (-4°F) to 50°C (122°F)	
Cavity	SAE 08/3	SAE 10/3
Coil type*	BC	BQ16
Nominal voltages	12 VDC - 24 VDC ± 10%	12 VDC ± 10%
Power rating	26.1 W (12 VDC) 25.9 W (24 VDC)	30 W
Weight	0.23 kg (0.50 lb)	0.27 kg (0.59 lb)

NOTE - For different conditions, please contact Walvoil Sales Dpt. - *For coils further features see from page 206.

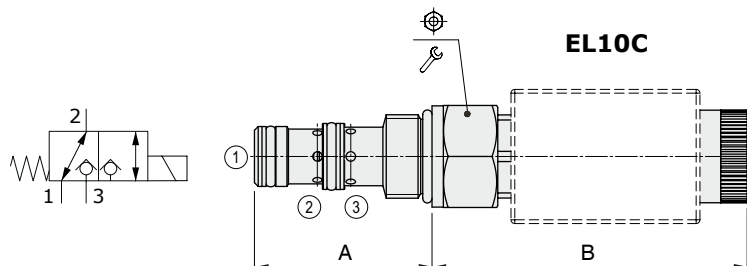

Valve type	A		B		⊕	⌘	Nm	lbft
	mm	in	mm	in				
EL08A/10NB	41,2	1.62	94.9	3.74	27	50	22	
EL10C/10NB	46	1.81	86.7	3.41	27	50	37	

For dimensions with different type of emergency stop see page 213

Ordering codes and description composition

EL08A/10 NB

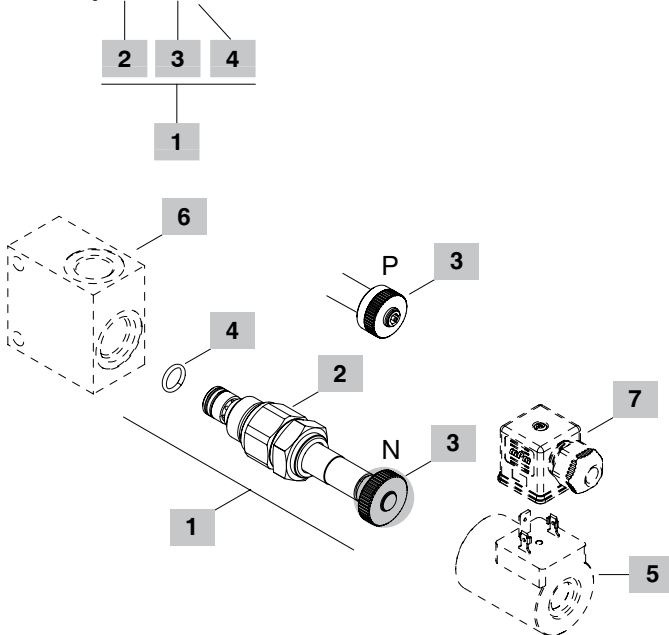

1 Cartridges

TYPE	CODE	DESCRIPTION
SAE cavity 08/3		
EL08A/10NB	0EL08002001	Without emergency
EL08A/10PB	0EL08002000	With push-button emergency
SAE cavity 10/3		
EL10C/10NB	0EL10002008	Without emergency

2 Spool

TYPE	DESCRIPTION
1	Spool 1

3 Emergency

TYPE	DESCRIPTION
N	Without emergency
P	Push button type

Note: for 10/2 cavity only **N** type

4 Seals

TYPE	DESCRIPTION
B	NBR (Buna) o-ring seals, std configuration
V	FPM (Viton) o-ring seals, contact Sales Dept.

5 Coils

TYPE	CODE	DESCRIPTION
BC 12 VDC	4SL8000120	12VDC-ISO4400 coil for EL08A
BQ16 12VDC	4SL8000121	12VDC-ISO4400 coil for EL10C

For complete coils list see from page 206

6 Valve body

TYPE	CODE	DESCRIPTION
SAE 08/3-SAE8	3CC0830K11	Aluminium body for cavity 08 valve, SAE8 std thread
SAE 10/3-SAE8	3CC1030K11	Aluminium body for cavity 10 valve, SAE8 std thread

For steel bodies or different threading see from page 217

7 Connector

TYPE	CODE	DESCRIPTION
ISO4400	4CN1009995	Connector

For complete connectors list see from page 206

Rating diagrams

Pressure drop vs. flow EL08A

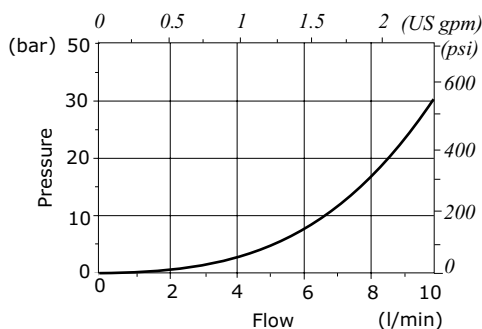

Pressure drop vs. flow EL10C

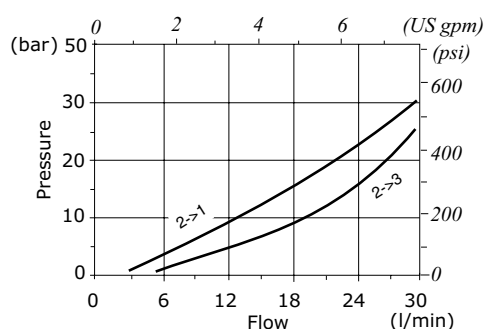

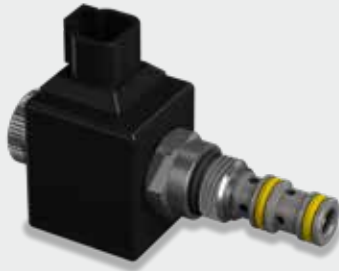

EL08B type directional solenoid valve - 3 way / 2 positions

- Direct acting
- Poppet type
- SAE08 cavity
- Low power consumption

Technical specifications and diagrams are measured with mineral oil of 46 cSt viscosity at 40°C (104°F) temperature.

		EL08B
Nominal flow		10 l/min (2.64 US gpm)
Max. pressure		250 bar (3600 psi)
Oil leakage	at 210 bar (3050 psi)	0.25 cm ³ /min (0.015 in ³ /min)
Fluid		mineral based oil
Viscosity		10-200 cSt
Max level of contamination		18/16/13 ISO4406
Fluid temperature	<i>with NBR seals</i>	from -20°C (-4°F) to 80°C (176°F)
	<i>with FPM seals</i>	from -20°C (-4°F) to 100°C (212°F)
Environmental temp. for working conditions		from -20°C (-4°F) to 50°C (122°F)
Cavity		SAE 08/3
Coil type*		BER
Nominal voltages		12 VDC - 24 VDC ± 10%
Power rating		19 W
Weight		0.16 kg (0.35 lb)

NOTE - For different conditions, please contact Walvoil Sales Dpt. - *For coils further features see from page 206.

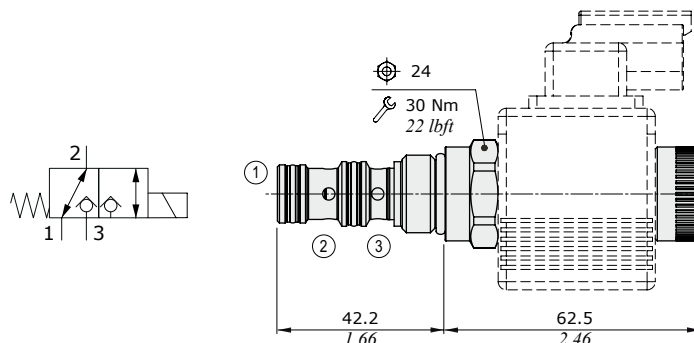

Ordering codes and description composition

EL08B/10 NB

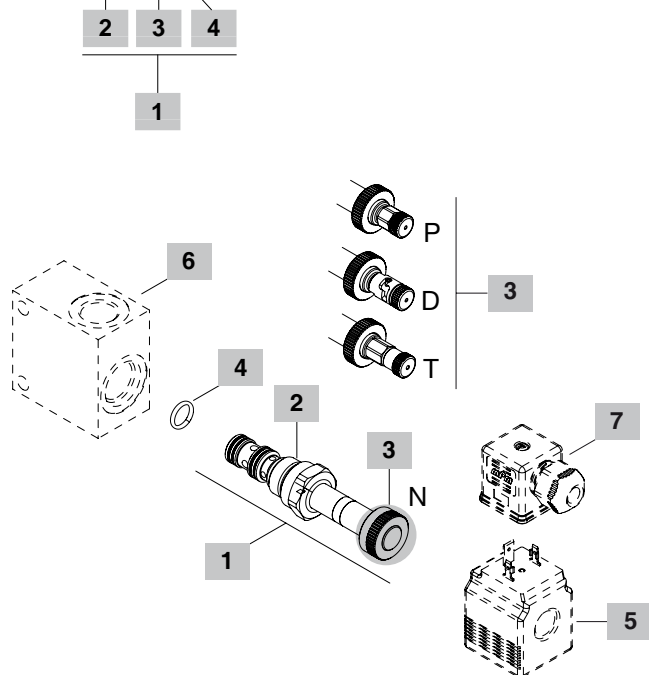

1 Cartridges

TYPE	CODE	DESCRIPTION
EL08B/10NB	0EL08002009	Without emergency
EL08B/10PB	0EL08002006	With push-button emergency
EL08B/10TB	0EL08002007	Screw type emergency
EL08B/10DB	0EL08002008	Push type with detent emergency

2 Spool

TYPE	DESCRIPTION
1	Spool 1

3 Emergency

TYPE	DESCRIPTION
N	Without emergency
P	Push-button emergency
T	Screw type emergency
D	Push type with detent emergency

4 Seals

TYPE	DESCRIPTION
B	NBR (Buna) o-ring seals, std configuration
V	FPM (Viton) o-ring seals, contact Sales Dept.

5 Coil

TYPE	CODE	DESCRIPTION
BER 12 VDC	4SLE001200A	Bobina 12VDC-ISO4400

For complete coils list see from page 206

6 Valve body

TYPE	CODE	DESCRIPTION
SAE 08/3-SAE8	3CC0830K11	Aluminium body for cavity 08 valve, SAE8 std thread

For steel bodies or different threading see from page 217

7 Connector

TYPE	CODE	DESCRIPTION
ISO4400	4CN1009995	Connector

For complete connectors list see from page 206

Rating diagrams

Pressure drop vs. flow

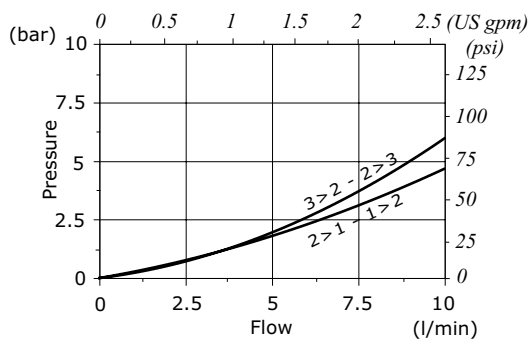

Performance limit

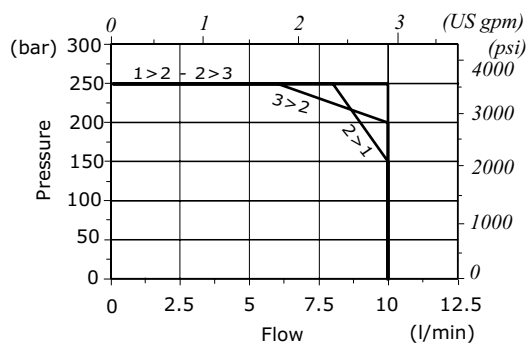



ER..M type directional solenoid valve - 4 way / 2 positions

- Direct acting
- Spool type
- From SAE08 to SAE12 cavities

Technical specifications and diagrams are measured with mineral oil of 46 cSt viscosity at 40°C (104°F) temperature.

	ER08M	ER10M	ER12M	
Nominal flow	20 l/min (5.3 US gpm)	40 l/min (10.5 US gpm)	60 l/min (15.8 US gpm)	
Max. pressure	port 1	210 bar (3050 psi)	250 bar (3600 psi)	
	port 2,3,4	210 bar (3050 psi)	320 bar (4600 psi)	
Oil leakage	at 210 bar (3050 psi)	40 cm ³ /min (2.44 in ³ /min)	80 cm ³ /min (4.88 in ³ /min)	200 cm ³ /min (12.20 in ³ /min)
Fluid	mineral based oil			
Viscosity	10-200 cSt			
Max level of contamination	18/16/13 ISO4406			
Fluid temperature	with NBR seals	from -20°C (-4°F) to 80°C (176°F)		
	with FPM seals	from -20°C (-4°F) to 100°C (212°F)		
Environmental temp. for working conditions	from -20°C (-4°F) to 50°C (122°F)			
Cavity	SAE 08/4	SAE 10/4	SAE 12/4	
Coils type*	BER	BC	BH	
Nominal voltages	12 VDC - 24 VDC ± 10%	12 VDC - 24 VDC ± 10%	12 VDC - 24 VDC ± 10%	
Power rating	22.8 W (12 VDC)	26.1 W (12 VDC)	33 W (12/24 VDC)	
	22.5 W (24 VDC)	25.9 W (24 VDC)		
Weight	0.20 kg (0.44 lb)	0.50 kg (1.10 lb)	0.73 kg (1.61 lb)	

NOTE - For different conditions, please contact Walvoil Sales Dpt. - *For coils further features see from page 206.

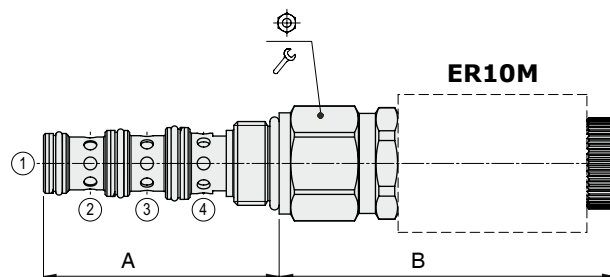
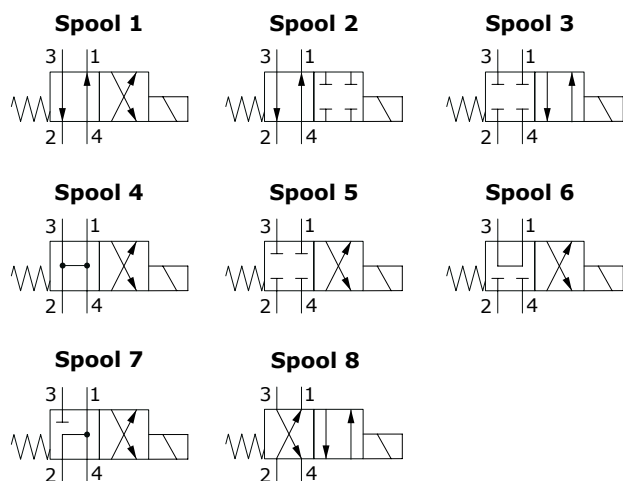

Valve type	A		B		⌀	⌀	Nm	lbft
	mm	in	mm	in				
ER08M/..NB	53.6	2.11	75	2.95	24	30	22	
ER10M/..NB	62.4	2.46	89	3.50	27	50	37	
ER12M/..NB	81.4	3.20	85.5	3.37	32	85	63	

For dimensions with different type of emergency see page 213

Ordering codes and description composition

ER08M/10 NB

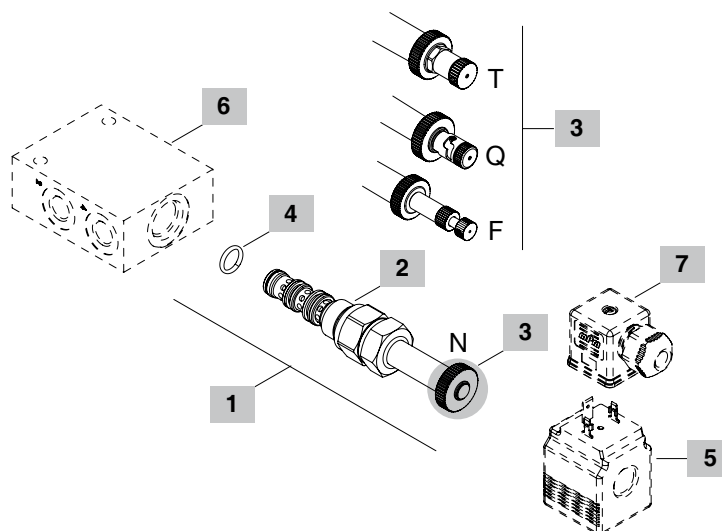
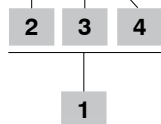
**1 Cartridges**

TYPE	CODE	DESCRIPTION
SAE cavity 08/4		
ER08M/10NB	0ER08002016	Without emergency, spool 1
ER08M/20NB	0ER08002017	Without emergency, spool 2
ER08M/30NB	0ER08002018	Without emergency, spool 3
ER08M/40NB	0ER08002019	Without emergency, spool 4
ER08M/50NB	0ER08002020	Without emergency, spool 5
ER08M/60NB	0ER08002021	Without emergency, spool 6
ER08M/70NB	0ER08002022	Without emergency, spool 7
ER08M/80NB	0ER08002023	Without emergency, spool 8
SAE cavity 10/4		
ER10M/10NB	0ER10002023	Without emergency, spool 1
ER10M/20NB	0ER10002024	Without emergency, spool 2
ER10M/30NB	0ER10002025	Without emergency, spool 3
ER10M/40NB	0ER10002026	Without emergency, spool 4
ER10M/50NB	0ER10002027	Without emergency, spool 5
ER10M/60NB	0ER10002028	Without emergency, spool 6
ER10M/70NB	0ER10002029	Without emergency, spool 7
ER10M/80NB	0ER10002030	Without emergency, spool 8
SAE cavity 12/4		
ER12M/10NB	0ER12002021	Without emergency, spool 1
ER12M/20NB	0ER12002023	Without emergency, spool 2
ER12M/50NB	0ER12002024	Without emergency, spool 5
ER12M/80NB	0ER12002022	Without emergency, spool 8

2 Spool

TYPE	DESCRIPTION
1	Spool 1
2	Spool 2
3	Spool 3
4	Spool 4
5	Spool 5
6	Spool 6
7	Spool 7
8	Spool 8

3 Emergency

TYPE	DESCRIPTION
N	Without emergency
F	Pull button type
Q	Pull type with detent
T	Screw type

4 Seals

TYPE	DESCRIPTION
B	NBR (Buna) o-ring seals, std configuration (*)
V	FPM (Viton) o-ring seals, contact Sales Dept.

Note (*): for ER12M, NBR and polyurethane D-ring

5 Coils

TYPE	CODE	DESCRIPTION
BER 12VDC-ISO4400	4SLE001200	12VDC-ISO4400 coil for ER08M
BC 12VDC-ISO4400	4SL8000120	12VDC-ISO4400 coil for ER10M
BH 12VDC-ISO4400	4SLD001200	12VDC-ISO4400 coil for ER12M

For complete coils list see from page 206

6 Valve body

TYPE	CODE	DESCRIPTION
SAE 08/4-SAE8	3CC0840K11	Aluminium body for cavity 08 valve, SAE8 std thread
SAE 10/4-SAE8	3CC1040K11	Aluminium body for cavity 10 valve, SAE8 std thread
SAE 12/4-SAE10	3CC1240L11	Aluminium body for cavity 12 valve, SAE10 thread

Note: aluminium body can stand up to 210 bar (3050 psi)
For steel bodies or different threading see from page 219

7 Connector

TYPE	CODE	DESCRIPTION
ISO4400	4CN1009995	Connector

For complete connectors list see from page 206

Rating diagrams

ER08M pressure drop vs. flow
 - Spool 1 -

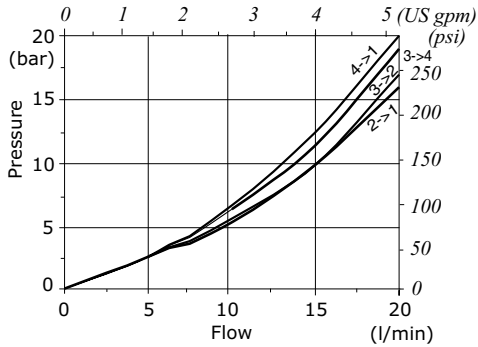

ER08M pressure drop vs. flow
 - Spool 2 -

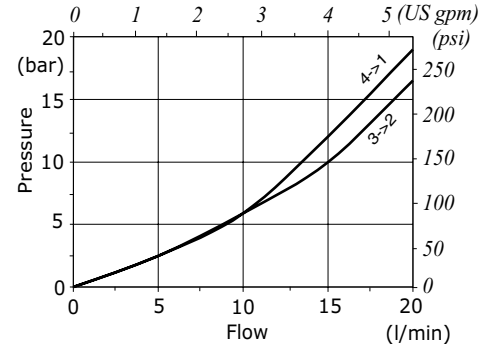

ER08M pressure drop vs. flow
 - Spool 3 -

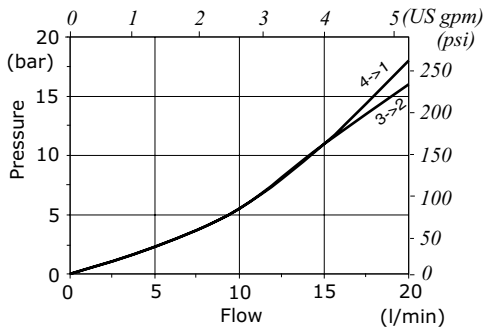

ER08M pressure drop vs. flow
 - Spool 4 -

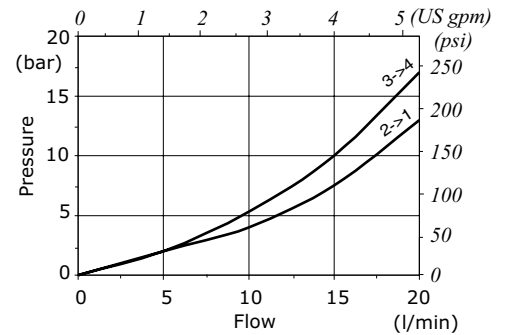

ER08M pressure drop vs. flow
 - Spool 5 -

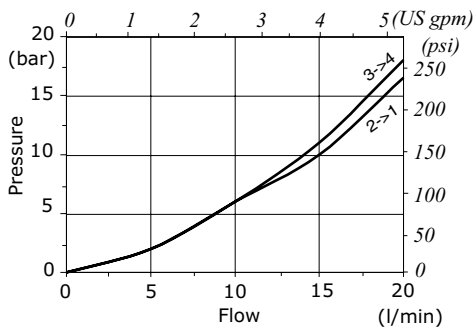

ER08M pressure drop vs. flow
 - Spool 6 -

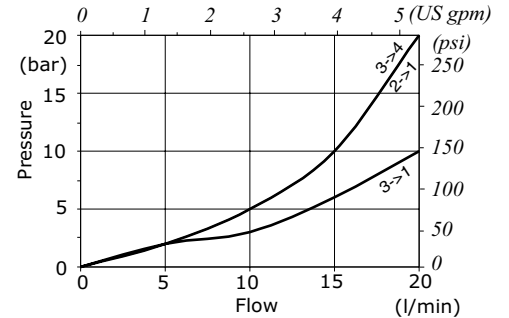

ER08M pressure drop vs. flow
 - Spool 7 -

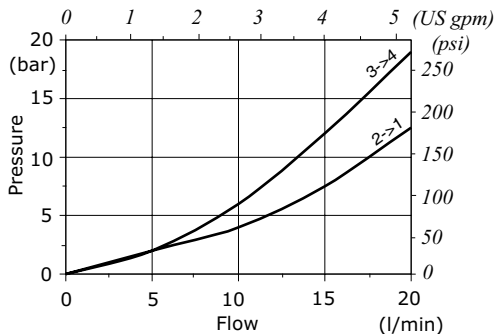

ER08M performance limit

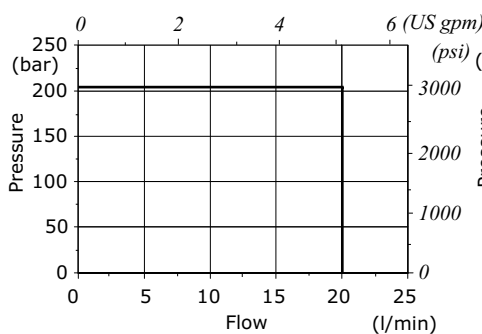

ER08M pressure drop vs. flow
 - Spool 8 -

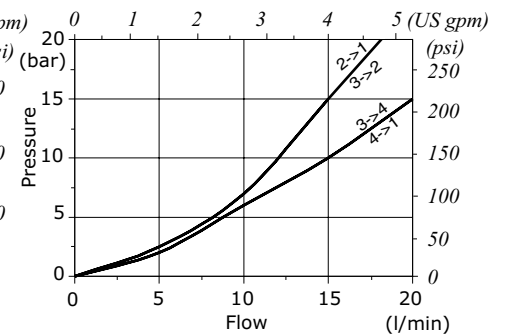

Rating diagrams

ER10M pressure drop vs. flow
- Spool 1 -

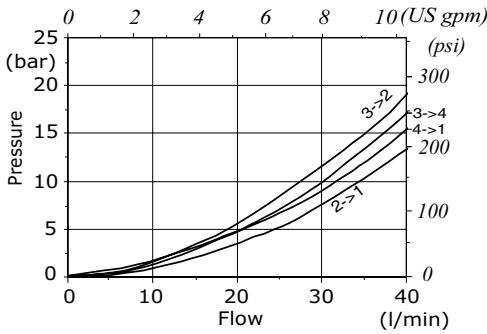

ER10M pressure drop vs. flow
- Spool 2 -

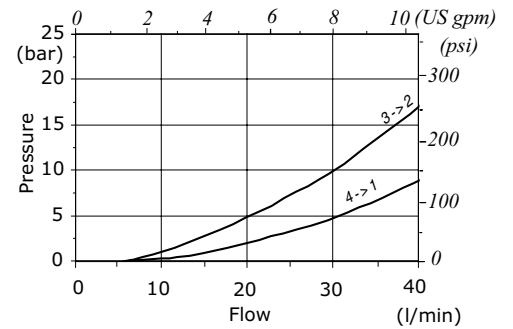

ER10M pressure drop vs. flow
- Spool 3 -

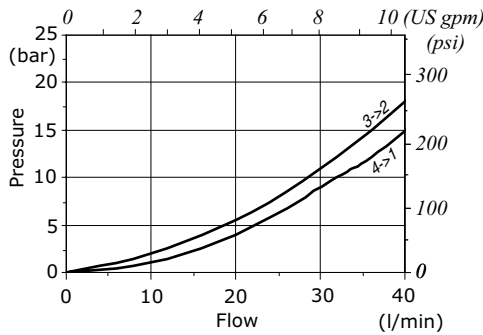

ER10M pressure drop vs. flow
- Spool 4 -

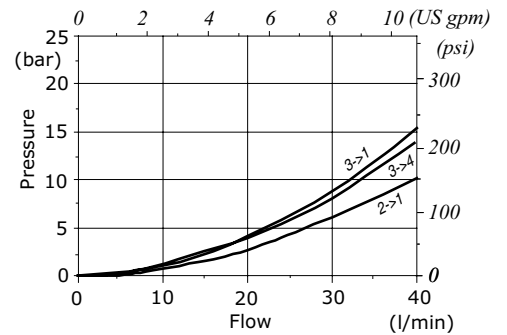

ER10M pressure drop vs. flow
- Spool 5 -

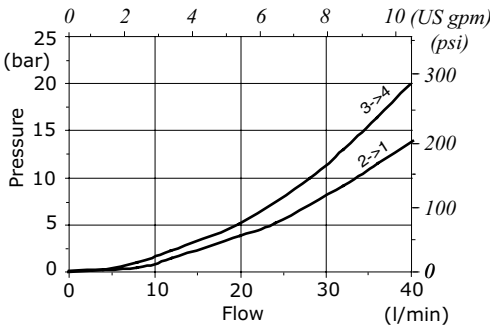

ER10M pressure drop vs. flow
- Spool 6 -

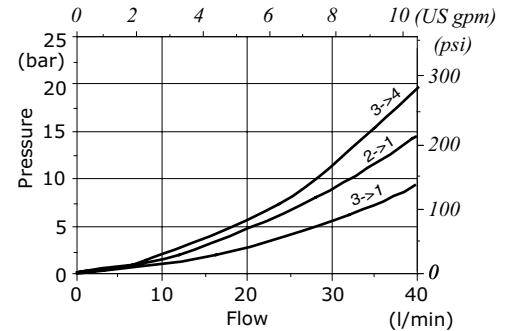

ER10M pressure drop vs. flow
- Spool 7 -

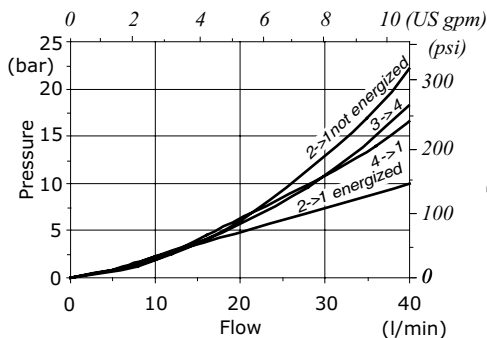

ER10M performance limit

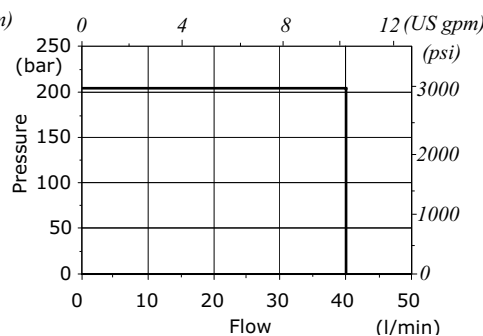

ER10M pressure drop vs. flow
- Spool 8 -

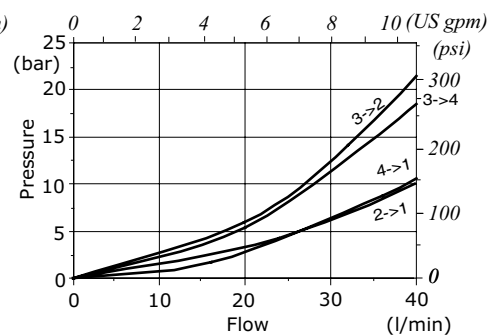

Rating diagrams

ER12M pressure drop vs. flow
 - Spool 1 -

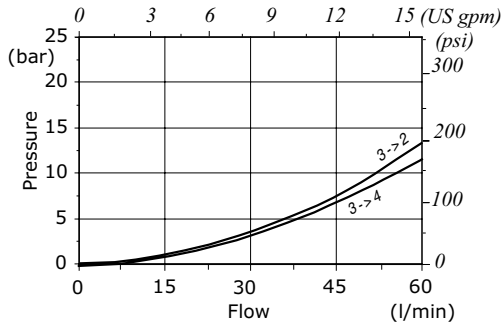

ER12M pressure drop vs. flow
 - Spool 2 -

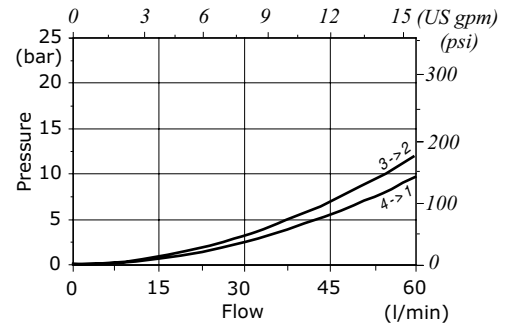

ER12M pressure drop vs. flow
 - Spool 5 -

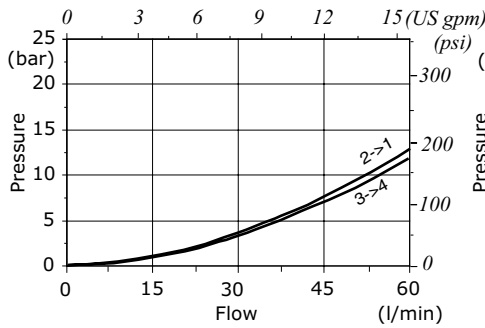

ER12M performance limit

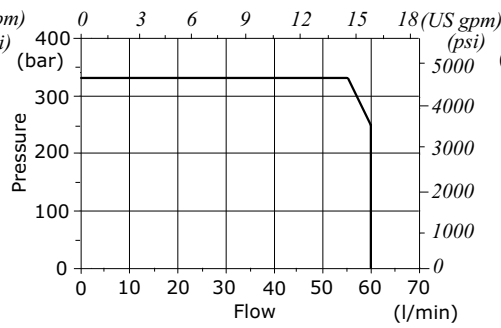

ER12M pressure drop vs. flow
 - Spool 8 -

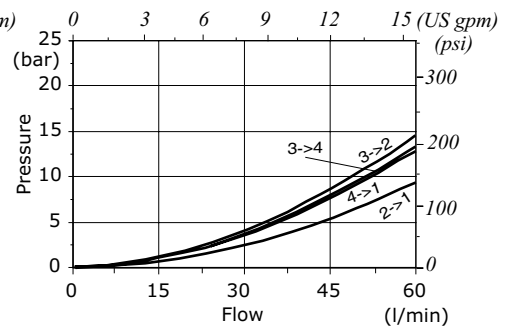



ET..M type directional solenoid valve - 4 way / 3 positions

- Direct acting
- Spool type
- From SAE08 to SAE10 cavities

Technical specifications and diagrams are measured with mineral oil of 46 cSt viscosity at 40°C (104°F) temperature.

	ET08M	ET10M
Nominal flow	18 l/min (4.7 US gpm)	40 l/min (10.5 US gpm)
Max. pressure	210 bar (3050 psi)	
Oil leakage	at 210 bar (3050 psi) 40 cm ³ /min (2.44 in ³ /min)	80 cm ³ /min (4.88 in ³ /min)
Fluid	mineral based oil	
Viscosity	10-200 cSt	
Max level of contamination	18/16/13 ISO4406	
Fluid temperature	with NBR seals with FPM seals	from -20°C (-4°F) to 80°C (176°F) from -20°C (-4°F) to 100°C (212°F)
Environmental temp. for working conditions	from -20°C (-4°F) to 50°C (122°F)	
Cavity	SAE 08/4	SAE 10/4
Coils type*	BER	BC
Nominal voltages	12 VDC - 24 VDC ± 10%	12 VDC - 24 VDC ± 10%
Power rating	22.8 W (12 VDC) - 22.5 W (24 VDC)	26.1 W (12 VDC) - 25.9 W (24 VDC)
Weight	0.25 kg (0.44 lb)	0.45 kg (1.10 lb)

NOTE - For different conditions, please contact Walvoil Sales Dpt. - *For coils further features see from page 206.

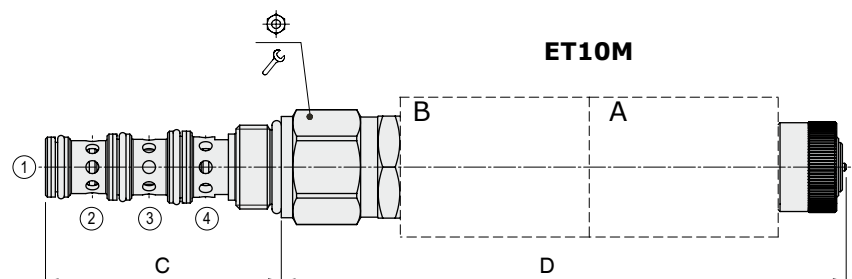
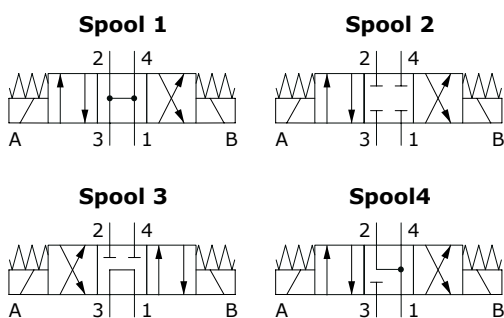

Valve type	C		D		⊕	⌘	Nm	lbft
	mm	in	mm	in				
ET08M/..NB	53.6	2.11	120	4.72	24	30	22	
ET10M/..NB	62.4	2.46	148.5	5.85	27	50	37	

For dimensions with different type of emergency see page 213

Ordering codes and description composition

ET08M/10 NB

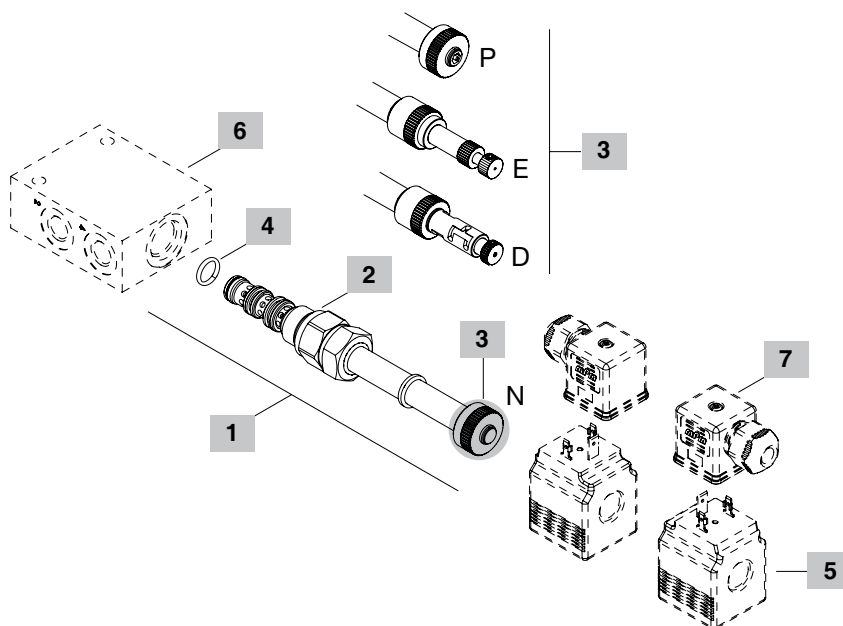
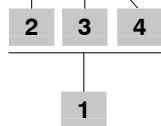

1 Cartridges

TYPE	CODE	DESCRIPTION
SAE cavity 08/4		
ET08M/10NB	0ET08002017	Without emergency, spool 1
ET08M/20NB	0ET08002019	Without emergency, spool 2
ET08M/30NB	0ET08002020	Without emergency, spool 3
ET08M/40NB	0ER08002018	Without emergency, spool 4
SAE cavity 10/4		
ET10M/10NB	0ET10002023	Without emergency, spool 1
ET10M/20NB	0ET10002024	Without emergency, spool 2
ET10M/30NB	0ET10002025	Without emergency, spool 3
ET10M/40NB	0ET10002026	Without emergency, spool 4

2 Spool

TYPE	DESCRIPTION
1	Spool 1
2	Spool 2
3	Spool 3
4	Spool 4

3 Emergency

TYPE	DESCRIPTION
N	Without emergency
E	Pull/push-button type
D	Detent push/pull type
P	Push-button type

4 Seals

TYPE	DESCRIPTION
B	NBR (Buna) o-ring seals, std configuration
V	FPM (Viton) o-ring seals, contact Sales Dept.

5 Coils

TYPE	CODE	DESCRIPTION
BER 12VDC	4SLE001200	12VDC-ISO4400 coil for ET08M
BC 12VDC	4SL8000120	12VDC-ISO4400 coil for ET10M

For complete coils list see from page 206

6 Valve body

TYPE	CODE	DESCRIPTION
SAE 08/4-SAE8	3CC0840K11	Aluminium body for cavity 08 valve, SAE8 std thread
SAE 10/4-SAE8	3CC1040K11	Aluminium body for cavity 10 valve, SAE8 std thread

For steel bodies or different threading see from page 219

7 Connector

TYPE	CODE	DESCRIPTION
ISO4400	4CN1009995	Connector

For complete connectors list see from page 206

Rating diagrams

ET08M pressure drop vs. flow
 - Spool 1 -

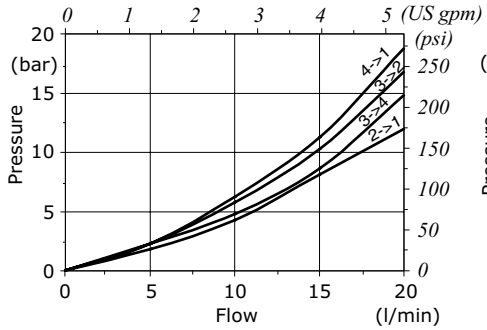

ET08M pressure drop vs. flow
 - Spool 2 -

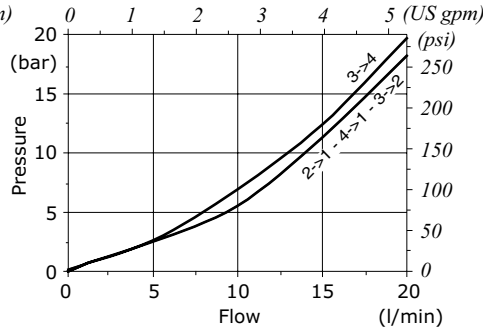

ET08M pressure drop vs. flow
 - Spool 3 -

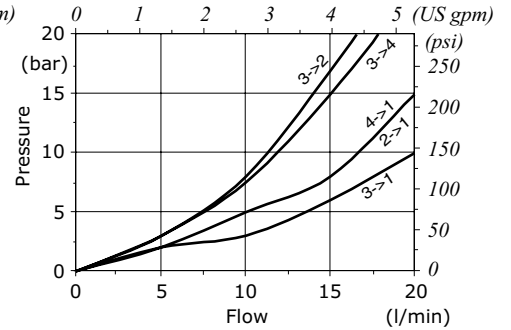

ET08M pressure drop vs. flow
 - Spool 4 -

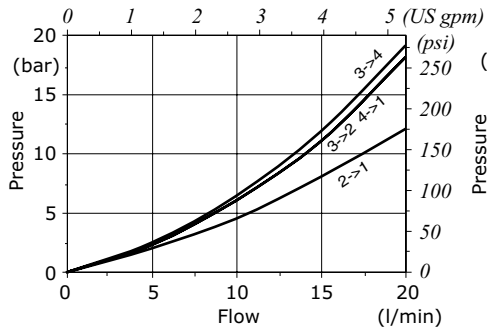

ET08M performance limit

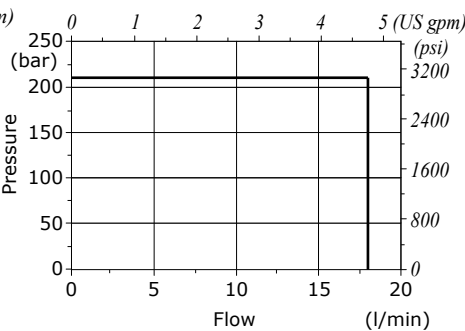

ET10M pressure drop vs. flow
 - Spool 1 -

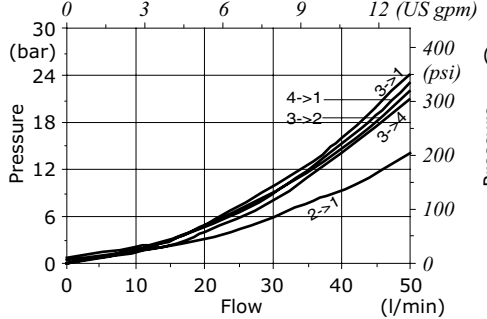

ET10M pressure drop vs. flow
 - Spool 2 -

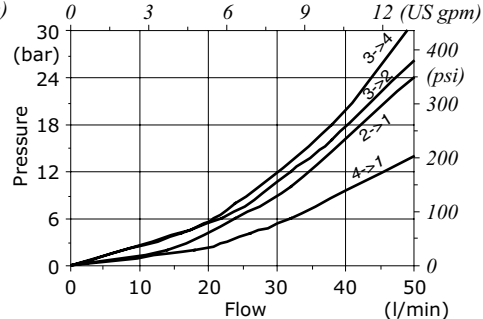

ET10M pressure drop vs. flow
 - Spool 3 -

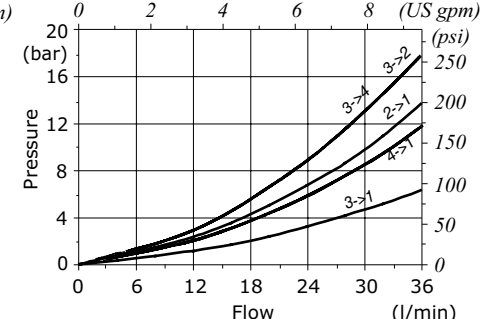

ET10M pressure drop vs. flow
 - Spool 4 -

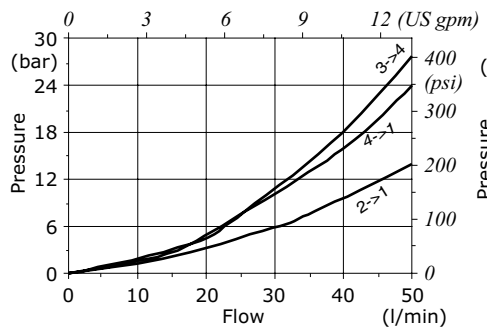

ET10M performance limit

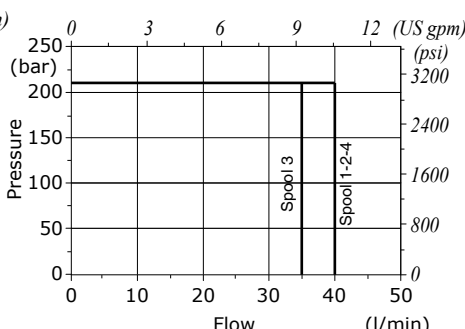



ET12A type directional solenoid valve - 4 way / 3 positions

- Direct acting
- Spool type

Technical specifications and diagrams are measured with mineral oil of 46 cSt viscosity at 40°C (104°F) temperature.

ET12A		
Nominal flow		40 l/min (10.5 US gpm)
Max. pressure		210 bar (3050 psi)
Oil leakage	at 210 bar (3050 psi)	120 cm ³ /min (7.32 in ³ /min)
Fluid		mineral based oil
Viscosity		10-200 cSt
Max level of contamination		18/16/13 ISO4406
Fluid temperature	with NBR seals	from -20°C (-4°F) to 80°C (176°F)
	with FPM seals	from -20°C (-4°F) to 100°C (212°F)
Environmental temp. for working conditions		from -20°C (-4°F) to 50°C (122°F)
Cavity		SAE 12/4
Coil type*		BIN 22
Nominal voltages		12 VDC - 24 VDC ± 10%
Power rating		32.6 W (12 VDC) - 31 W (24 VDC)
Weight		0.720 kg (1.59 lb)

NOTE - For different conditions, please contact Walvoil Sales Dpt. - *For coils further features see from page 206.

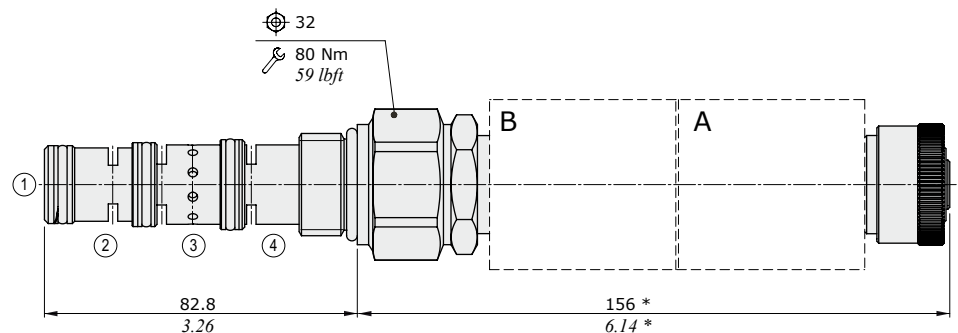
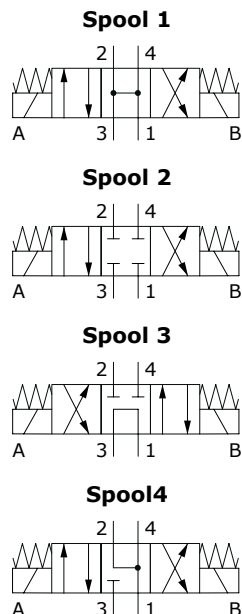

NOTE (*) : dimensions for configuration **ET12A/10NB**, for dimensions with different type of emergency see page 213.

Ordering codes and description composition

ET12A/10 NB

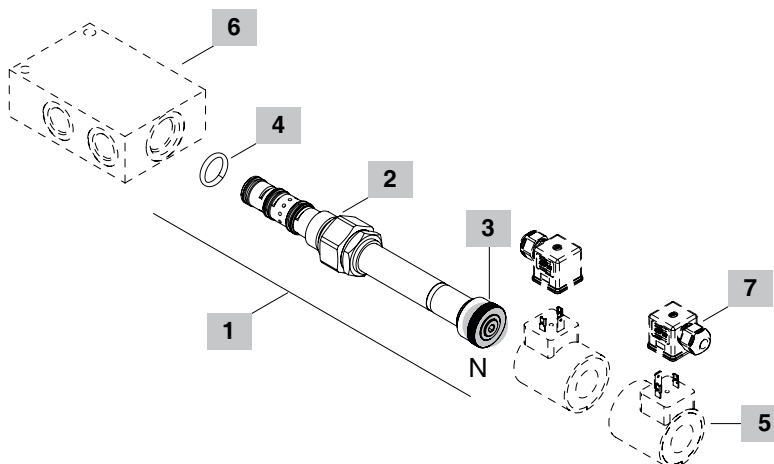
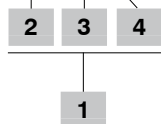

1 Cartridges

TYPE	CODE	DESCRIPTION
SAE cavity 12/4		
ET12A/10NB	0ET12002012	Without emergency, spool 1
ET12A/10PB	0ET12002013	Push-button emergency, spool 1
ET12A/20NB	0ET12002009	Without emergency, spool 2
ET12A/20PB	0ET12002014	Push-button emergency, spool 2
ET12A/30NB	0ET12002010	Without emergency, spool 3
ET12A/30PB	0ET12002015	Push-button emergency, spool 3
ET12A/40NB	0ET12002011	Without emergency, spool 4
ET12A/40PB	0ET12002016	Push-button emergency, spool 4

2 Spool

TYPE	DESCRIPTION
1	Spool 1
2	Spool 2
3	Spool 3
4	Spool 4

3 Emergency

TYPE	DESCRIPTION
N	Without emergency
P	Push button type

4 Seals

TYPE	DESCRIPTION
B	NBR (Buna) o-ring seals, std configuration
V	FPM (Viton) o-ring seals, contact Sales Dept.

5 Coils

TYPE	CODE	DESCRIPTION
BIN22 12VDC	4SL6000128	12VDC-ISO4400 coil

For complete coils list see from page 206

6 Valve body

TYPE	CODE	DESCRIPTION
SAE 12/4-SAE10	3CC1240L11	Aluminium body for cavity 12 valve, SAE10 std thread

For steel bodies or different threading see from page 219

7 Connector

TYPE	CODE	DESCRIPTION
ISO4400	4CN1009995	Connector

For complete connectors list see from page 206

Rating diagrams

ET12A pressure drop vs. flow
 - Spool 1 -

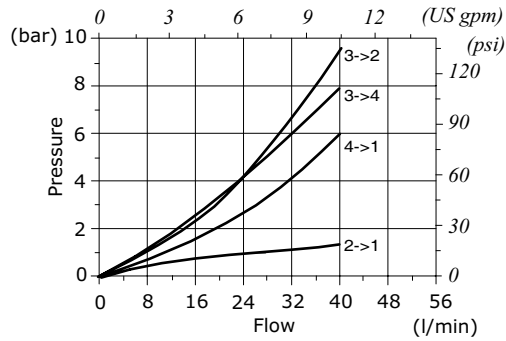

ET12A pressure drop vs. flow
 - Spool 2 -

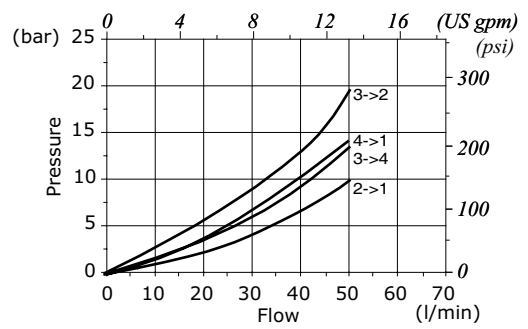

ET12A pressure drop vs. flow
 - Spool 3 -

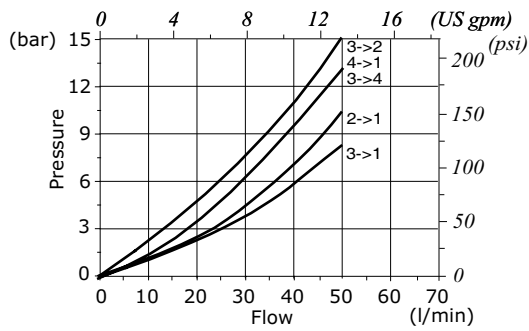

ET12A pressure drop vs. flow
 - Spool 4 -

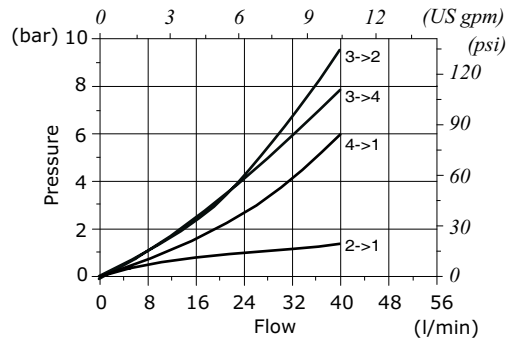

Types and ordering codes

Valve type	Coil	Voltage	Connector					
			ISO4400	Deutsch DT	AMP JPT	Packard Weather-pack	Packard Metri-pack	Flying leads
Directional solenoid valves								
EA08A	BE	12 VDC	4SL1000120A	4SL1000123A ⁽⁶⁾ 4SL1000140 ⁽³⁻⁶⁾ 4SL1000124 ⁽²⁾	-	-	-	4SL1000122A
		24 VDC	4SL1000240A 4SL1030240 ⁽¹⁾	4SL1002401 ⁽⁶⁾	4SL1000125A ⁽³⁻⁵⁾	-	-	-
		110 VDC	4SL1011100 4SL1031100 ⁽¹⁾	-	-	-	-	-
		220 VDC	4SL1022200 4SL1032200 ⁽¹⁾	-	-	-	-	-
EA08B EW08A EJ08F EJ08G	BT	10 VDC	4SL3000100	-	-	-	-	
		12 VDC	4SL3000120 4SL3000126 ⁽⁴⁾	4SL3000130 ⁽⁶⁾ 4SL3000134 ⁽³⁻⁶⁾ 4SL3000128 ⁽²⁾	4SL3000122 ⁽⁵⁾ 4SL3001200 ⁽³⁻⁵⁾	4SL3000124 ⁽²⁾	4SL3000127 ⁽²⁾	4SL300012C
		24 VDC	4SL3000240 4SL3030240 ⁽¹⁾	4SL3000249 ⁽⁶⁾ 4SL300024C ⁽³⁻⁶⁾	4SL3000248 ⁽⁵⁾	-	-	4SL3000246
		26 VDC	4SL3000260	-	-	-	-	-
		48 VDC	4SL3000480 4SL3030480 ⁽¹⁾	-	-	-	-	-
		110 VDC	4SL3001100 4SL3031100 ⁽¹⁾	-	-	-	-	-
EW10M	BH	12 VDC	4SLD001200A	4SLD001201A ⁽⁶⁾	4SLD001207A ⁽⁶⁾	-	-	4SLD001203A
		24 VDC	4SLD002400A	4SLD002401A ⁽⁶⁾	4SLD002407A ⁽⁶⁾	-	-	4SLD002403A
EE08A EC..M EF..M EJ8CA EJ08M ER08M ET08M EL08B	BER	10 VDC	4SLE001000A	-	-	-	-	-
		12 VDC	4SLE001200A 4SLE001217A ⁽³⁾	4SLE001201A ⁽⁵⁾ 4SLE001209A ⁽³⁻⁵⁾ 4SLE001202A ⁽⁶⁾ 4SLE001216A ⁽³⁻⁶⁾ 4SLE001206A ⁽²⁾	4SLE001203A ⁽⁵⁾ 4SLE001211A ⁽³⁻⁵⁾	4SLE001210A ⁽²⁾	4SLE001214 ⁽²⁾	4SLE001207A
		24 VDC	4SLE002400A 4SLE002408A ⁽³⁾ 4SLE302400A ⁽¹⁾	4SLE002401A ⁽⁵⁾ 4SLE002407A ⁽³⁻⁵⁾ 4SLE002402A ⁽⁶⁾	4SLE002403A ⁽⁵⁾	-	-	4SLE002404A
		48 VDC	4SLE004800A 4SLE304800A ⁽¹⁾	-	-	-	-	-
		110 VDC	4SLE011000A 4SLE311000A ⁽¹⁾	-	-	-	-	-
		220 VDC	4SLE022000A 4SLE322000A ⁽¹⁾	-	-	-	-	-
EE10A EW10A EW10B	BIN19	10,5 VDC	4SL6000100	-	-	-	-	-
		12 VDC	4SL6000121	-	-	-	-	-
		24 VDC	4SL6000240	-	-	-	-	-
EE12A EW12A EW12C EJ12A ET12A	BIN22	12 VDC	4SL6000128	-	-	-	-	-
		24 VDC	4SL6000245	-	-	-	-	-
EJ10M EL08A ER10M ET10M	BC	10,5 VDC	4 SL8000110	-	-	-	-	-
		12 VDC	4SL8000120	4SL800012BA ⁽⁶⁾ 4SL8001201A ⁽⁶⁻³⁾	4SL8000127 ⁽⁵⁾ 4SL8000130 ⁽⁵⁻³⁾	-	-	4SL800012A
		24 VDC	4SL8000240 4SL8030240 ⁽¹⁾	4SL8000243 ⁽⁶⁾	4SL8000241 ⁽⁵⁾	-	-	4SL8000242
		26 VDC	4SL8000260	-	-	-	-	-
		48 VDC	4SL8030480 ⁽¹⁾	-	-	-	-	-
		110 VDC	4SL8031100 ⁽¹⁾	-	-	-	-	-
EL10C	BQ16	12 VDC	4SL8000121	4SL8000128 ⁽⁵⁾	-	-	4SL8000124 ⁽²⁾	4SL8000125
		24 VDC	4SL8002400	4SL8000245 ⁽⁵⁾	-	-	-	-

Types and ordering codes

Valve type	Coil	Voltage	Connector					
			ISO4400	Deutsch DT	AMP JPT	Packard Weather-pack	Packard Metri-pack	Flying leads
Pressure relief valves - Pressure reducing valves - Flow control pressure compensated valves								
MC08Y MP16Y RD08W RM..W RP..W	MP35	12 VDC	4SL4000120	-	-	-	-	-
		24 VDC	4SL4000240	-	-	-	-	-
MC10X MP..T MP..X PP..X PU..X EE..X EC..T	BQP19	12 VDC	4SL5000126A	4SL5000125A ⁽⁶⁾	4SL5000129A ⁽⁵⁾	-	-	-
		24 VDC	4SL5000245A	4SL5000244A ⁽⁶⁾	4SL5000248 ^(A5)	-	-	-
	BH	12 VDC	4SLD001200A	4SLD001201A ⁽⁶⁾	4SLD001207A ⁽⁶⁾	-	-	4SLD001203A
		24 VDC	4SLD002400A	4SLD002401A ⁽⁶⁾	4SLD002407A ⁽⁶⁾	-	-	4SLD002403A
RD08S RD08T	MSM19	12 VDC	4SL5000128	-	-	-	5SL5000122 ⁽²⁾	4SL5000122
		24 VDC	4SL5000247	-	-	-	5SL5000243 ⁽²⁾	4SL5000243
RP08X	BDP19	12 VDC	4SL5000120	-	-	-	-	-
		24 VDC	4SL5000240	-	-	-	-	-
Mating connectors (For connector with rectifier see following table)			4CN1009995	5CON140031	5CON003	5CON001	5CON017	-

Notes: ⁽¹⁾ supply with AC and use only with rectifier connector - ⁽²⁾ with flying leads - ⁽³⁾ with bidirectional diode - ⁽⁵⁾ with unidirectional diode - ⁽⁵⁾ integrated perpendicular type - ⁽⁶⁾ integrated parallel type

Voltage	ISO 4400 mating connector with rectifier			
	BT type coil	BE type coil	BER type coil	BC type coil
24 VDC	4CN3010240	4CN1010240	4CN1010240	4CN3010240
48 VDC	4CN3010480	4CN1010480	4CN1010480	4CN3010480
110 VDC	4CN3011100	4CN1011100	4CN1011100	4CN3011100
220 VDC	4CN3012200	4CN1012200	4CN1012200	4CN3012200

Dimensional data and features

BE type

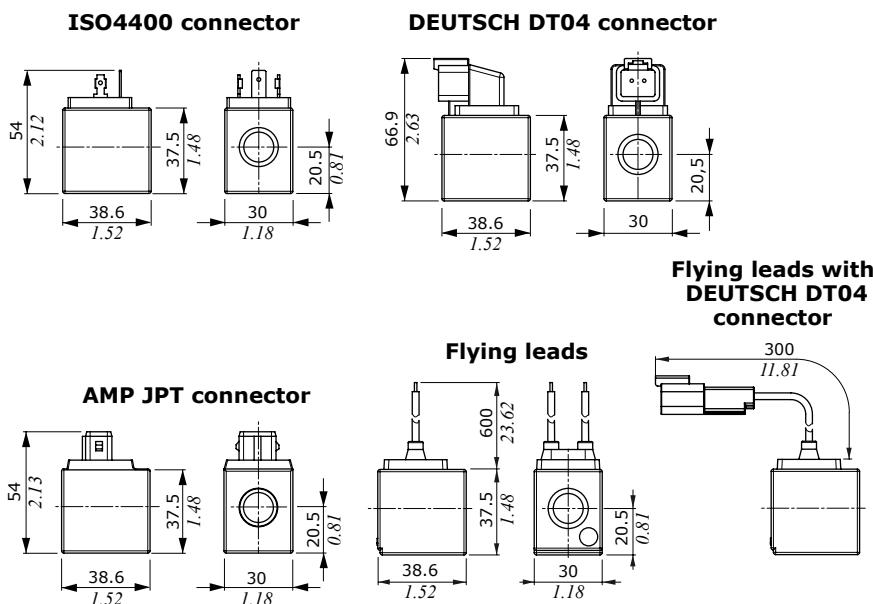

Features

- Nominal voltage tolerance : ±10%
- Power rating : 18.7 W - 12 VDC
: 18.6 W - 24 VDC
: 17.3 W - 110 VDC
: 15.7 W - 220 VDC
: 18.3 W - 24 RAC
: 16 W - 110 RAC
: 16 W - 220 RAC
- Max. operating current . . . : 1.56 A - 12 VDC
: 0.77 A - 24 VDC
: 0.157 A - 110 VDC
: 0.08 A - 220 VDC
: 0.85 A - 24 RAC
: 0.16 A - 110 RAC
: 0.08 A - 220 RAC
- Coil insulation : Class F (155°C - 311°F)
- Weather protection : IP65 - ISO4400
: IP69K - Deutsch DT
- Insertion : 100%

Types and dimensions

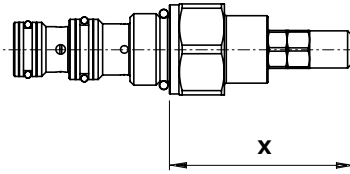

Valve type	Cavity	Dimension "X"					
		M handknob		S screw		V handwheel	
		mm	in	mm	in	mm	in
MC..A	08/2	-		53.5	2.11	83	3.46
	10/2	-		94.5	3.72	118	4.65
	12/2	-		126.5	4.98	153	5.602
MG..A	10/2	-		94.5	3.72	118	4.65
	12/2	-		126.5	4.98	150	5.91
MP..A	10/2	-		54.5	2.15	77.5	3.05
	12/2	-		52.5	2.07	75.5	2.97
	16/2	-		53	2.09	76	2.99
RB..A	08/3	-		79.5	3.13	103	4.05
	10/3	-		94.5	3.72	118	4.65
RD..A	08/3	-		79.5	3.13	103	4.05
	10/3	-		94.5	3.72	118	4.65
RM..A	10/3	-		54.5	2.15	66	2.60
	12/3	-		51.5	2.03	63	2.48
	16/3	-		50.5	1.99	62	2.44
RP..A	10/3	-		54.5	2.15	66	2.60
	12/3	-		51.5	2.03	63	2.48
	16/3	-		50.5	1.99	62	2.44
NB..A	08/2	52	2.05	49.5	1.95	-	-
	10/2	48	1.89	46.5	1.83	-	-
	12/2	49.2	1.94	46.3	1.82	-	-
	16/2	68.8	1.94	-	-	-	-

Valve type	Cavity	Dimension "X"					
		M handknob		S screw		V handwheel	
		mm	in	mm	in	mm	in
NT..A	08/2	67.5	2.66	64.5	2.54	-	-
	10/2	68	2.68	65	2.56	-	-
	12/2	69	2.72	66	2.60	-	-
	16/2	68.9	2.71	-	-	-	-
NU..A	08/2	66.5	2.62	64.5	2.54	-	-
	10/2	68	2.68	65	2.56	-	-
	12/2	69	2.72	66	2.60	-	-
	16/2	66.9	2.63	-	-	-	-
PW..A	08/2	64.5	2.54	62	2.44	-	-
	10/2	71.9	2.83	69.4	2.73	-	-
	12/2	64.5	2.54	62	2.44	-	-
	16/2	68	2.68	65.5	2.58	-	-
PU..A	08/2	48.5	1.91	46.5	1.83	-	-
	10/2	43	1.69	41	1.61	-	-
	12/2	44	1.73	42	1.65	-	-
	16/2	52	2.05	49	1.93	-	-
PP..A	08/3	49.5	1.95	46.5	1.83	-	-
	10/3	44	1.73	41	1.61	-	-
	12/3	45	1.77	42	1.65	-	-
	16/3	52	2.05	49	1.93	-	-

Types and dimensions

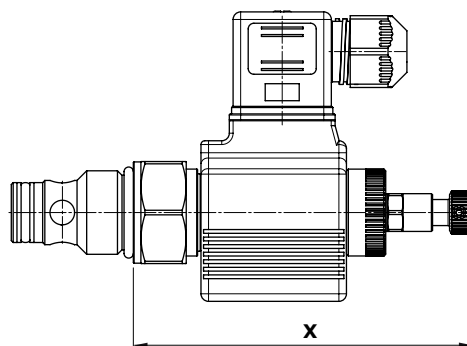

Valve type	Cavity	Dimension "X"															
		N / O without emergency		T screw type		P push button		D push type with detent		F pull button		Q pull type with detent		E with pull/push- button		V handknob	
		mm	in	mm	in	mm	in	mm	in	mm	in	mm	in	mm	in	mm	in
MC..X	10/2	86	3.39	105	4.13	-	-	-	-	-	-	-	-	-	-	-	-
MP..X	10/2	86	3.39	105	4.13	-	-	-	-	-	-	-	-	-	-	-	-
	12/2	102	4.02	121	4.76	-	-	-	-	-	-	-	-	-	-	-	-
EE..X	10/2	92.4	3.64	-	-	-	-	-	-	-	-	-	-	-	-	122	4.80
	12/2	94.9	3.74	-	-	-	-	-	-	-	-	-	-	-	-	124.5	4.90
EC..T	08/2	83	3.27	97.5	3.84	-	-	-	-	-	-	103.8	4.09	-	-	-	-
	10/2	83	3.27	97.5	3.84	-	-	-	-	-	-	103.8	4.09	-	-	-	-
	12/2	82.5	3.25	97	3.82	-	-	-	-	-	-	103.3	4.07	-	-	-	-
PU..X	16/2	81	3.19	95.5	3.76	-	-	-	-	-	-	101.8	4.01	-	-	-	-
	08/2	94	3.70	108	4.25	-	-	-	-	-	-	-	-	-	-	142	5.59
	10/2	96.4	3.79	110.4	4.35	-	-	-	-	-	-	-	-	-	-	144.4	5.69
	12/2	97.4	3.83	111.4	4.50	-	-	-	-	-	-	-	-	-	-	145.4	5.72
PP..X	16/2	121.4	4.78	135.4	5.33	-	-	-	-	-	-	-	-	-	-	169.4	6.67
	08/3	94	3.70	108	4.25	-	-	-	-	-	-	-	-	-	-	142	5.59
	10/3	96.4	3.79	110.4	4.35	-	-	-	-	-	-	-	-	-	-	144.1	5.67
	12/3	97.4	3.83	111.4	4.50	-	-	-	-	-	-	-	-	-	-	145.1	5.71
EA..A/1	08/2	60	2.36	79.3	3.12	-	-	-	-	-	-	-	-	-	-	-	-
EA..A/2	08/2	59	2.32	79	3.11	-	-	-	-	-	-	-	-	-	-	-	-
EA..B/1	08/2	70.9	2.79	90.3	3.56	-	-	-	-	-	-	-	-	-	-	-	-
EA..B/2	08/2	65.5	2.58	90.5	3.56	-	-	-	-	-	-	-	-	-	-	-	-
EE..A/1	08/2	76	2.99	-	-	-	-	-	-	-	-	-	-	-	-	-	-
EE..A/2	08/2	76	2.99	-	-	-	-	-	-	-	-	-	-	-	-	-	-
EE..A/1	10/2	-	-	-	-	90.3	3.56	-	-	-	-	-	-	-	-	-	-
EE..A/2	10/2	-	-	-	-	90.3	3.56	-	-	-	-	-	-	-	-	-	-
EE..A/1	12/2	-	-	-	-	102	4.02	-	-	-	-	-	-	-	-	-	-
EE..A/2	12/2	-	-	-	-	90.3	3.56	-	-	-	-	-	-	-	-	-	-
EC..M/1	08/2	67.2	2.64	90.1	3.55	90.1	3.55	92.8	3.65	-	-	-	-	-	-	-	-
EF..M/1	10/2	66.9	2.63	89.8	3.54	89.8	3.54	92.5	3.64	-	-	-	-	-	-	-	-
EH..M/1	12/2	61.1	2.40	84	3.31	84	3.31	86.8	3.42	-	-	-	-	-	-	-	-
EH..M/1	16/2	61.2	2.40	84.1	3.31	84.1	3.31	86.9	3.42	-	-	-	-	-	-	-	-
EH..M/1	08/2	63.3	2.49	77.8	3.06	-	-	-	-	91.3	3.59	83.8	3.30	-	-	-	-
EC..M/2	10/2	63	2.48	77.5	3.05	-	-	-	-	91	3.58	83.5	3.29	-	-	-	-
EF..M/2	12/2	57.2	2.25	71.7	2.82	-	-	-	-	85.2	3.35	77.7	3.06	-	-	-	-
EH..M/2	16/2	57.3	2.26	71.8	2.83	-	-	-	-	85.3	3.36	77.8	3.06	-	-	-	-
EW08A/1	08/2	65.7	2.59	73.5	2.89	-	-	-	-	-	-	-	-	-	-	-	-
EW08A/2	08/2	70.9	2.79	90.3	3.56	87.2	3.43	-	-	-	-	-	-	-	-	-	-
EW10B/1	10/2	99.8	3.93	-	-	-	-	-	-	-	-	-	-	-	-	-	-
EW10A/2	10/2	-	-	-	-	83.3	3.28	-	-	-	-	-	-	-	-	-	-

Types and dimensions

Valve type	Cavity	Dimension "X"															
		N / O without emergency		T screw type		P push button		D push type with detent		F pull button		Q pull type with detent		E with pull/push- button		V handknob	
		mm	in	mm	in	mm	in	mm	in	mm	in	mm	in	mm	in	mm	in
EW12B/1	12/2	102.8	4.05	-	-	-	-	-	-	-	-	-	-	-	-	-	-
EW12C/2	12/2	-	-	-	-	98.7	3.89	-	-	-	-	-	-	-	-	-	-
EW08M/1	08/2	60.1	2.37	77	3.03	-	-	-	-	88.1	3.47	81	3.19	-	-	-	-
EW08M/2	08/2	62.5	2.46	85.4	3.36	85.4	3.36	88.1	3.47	-	-	-	-	-	-	-	-
EW10M/2	10/2	81.3	3.20	95.3	3.75	104.2	4.10	106.3	4.19	-	-	-	-	-	-	-	-
EJ08F	08/3	65.7	2.59	73.5	2.89	-	-	-	-	-	-	-	-	-	-	-	-
EJ08G	08/3	65.7	2.59	73.5	2.89	-	-	-	-	-	-	-	-	-	-	-	-
EJ..M	08/3	56.1	2.21	70.6	2.78	-	-	-	-	84.1	3.31	77	3.03	-	-	-	-
	10/3	68	2.68	82.5	3.25	-	-	-	-	96	3.78	88.9	3.50	-	-	-	-
EL08A	08/3	94.9	3.74	-	-	96	3.78	-	-	-	-	-	-	-	-	-	-
EL10C	10/3	86.7	3.41	-	-	-	-	-	-	-	-	-	-	-	-	-	-
EL08B	08/3	62.5	2.46	85.4	3.36	85.4	3.36	88.1	3.47	-	-	-	-	-	-	-	-
	08/4	75	2.95	100	3.94	-	-	-	-	115.5	4.55	95.8	3.77	-	-	-	-
ER..M	10/4	89	3.50	110.5	4.35	-	-	-	-	129.5	5.10	110	4.35	-	-	-	-
	12/4	85.5	3.37	-	-	-	-	-	-	-	-	-	-	-	-	-	-
ET..M	08/4	120	4.72	-	-	121	4.76	165	6.50	-	-	-	-	165.6	6.52	-	-
	10/4	148.5	5.85	-	-	149.5	5.89	190.9	7.52	-	-	-	-	191.5	7.54	-	-
	12/4	156	6.14	-	-	156	6.14	-	-	-	-	-	-	-	-	-	-

Dimensions and ordering codes

Description composition

3/CC/- □ □ /20/ □ □ -1

Cavity

- 08
- 10
- 12
- 16

Ports

- B) G 1/4
- C) G 3/8
- D) G 1/2
- E) G 3/4
- F) G 1
- J) SAE6
- K) SAE8
- L) SAE10
- M) SAE12
- N) SAE16

Materials

- 1) Aluminium
- 2) Steel

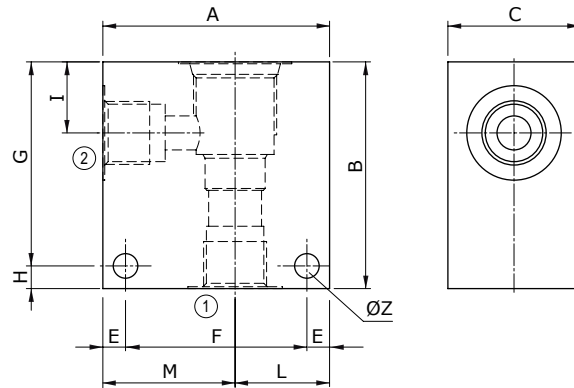

Material	Max. pressure	
	bar	psi
Alluminium	210	3050
Steel	350	5100

Cavity	Ports		Dimensions										Ordering code		
			A	B	C	E	F	G	H	I	L	M	ØZ	Aluminium	Steel
SAE 08/2	G 1/4	mm	50	50	30	6	38	44	6	14.8	20	30	6.5	3CC0820B11	3CC0820B21
		in	1.97	1.97	1.18	0.24	1.50	1.73	0.24	0.58	0.79	1.18	0.26		
	G 3/8	mm	50	50	30	6	38	44	6	14.8	20	30	6.5	3CC0820C11	3CC0820C21
		in	1.97	1.97	1.18	0.24	1.50	1.73	0.24	0.58	0.79	1.18	0.26		
	G 1/2	mm	60	60	35	6	48	54	6	18	25	35	6.5	3CC0820D11	/
		in	2.36	2.36	1.38	0.24	1.89	2.16	0.24	0.71	0.98	1.38	0.26		
SAE6	mm	50	50	30	6	38	44	6	14.8	20	30	6.5	3CC0820J11	3CC0820J21	
	in	1.97	1.97	1.18	0.24	1.50	1.73	0.24	0.58	0.79	1.18	0.25			
SAE8	mm	60	60	30	6	48	54	6	14	25	35	6.5	3CC0820K11	3CC0820K21	
	in	2.36	2.36	1.18	0.24	1.89	2.16	0.24	0.55	0.98	1.38	0.25			
SAE 10/2	G 1/4	mm	60	60	35	6	48	54	6	18.8	25	35	6.5	3CC1020B11	3CC1020B21
		in	2.36	2.36	1.38	0.24	1.89	2.12	0.24	0.74	0.98	1.38	0.26		
	G 3/8	mm	60	60	35	6	48	54	6	18.8	25	35	6.5	3CC1020C11	3CC1020C21
		in	2.36	2.36	1.38	0.24	1.89	2.12	0.24	0.74	0.98	1.38	0.26		
	G 1/2	mm	60	60	35	6	48	54	6	18.8	25	35	6.5	3CC1020D11	3CC1020D21
		in	2.36	2.36	1.38	0.24	1.89	2.12	0.24	0.74	0.98	1.38	0.26		
	SAE6	mm	60	70	35	6	48	64	6	18.8	25	35	6.5	3CC1020J11	3CC1020J21
		in	2.36	2.75	1.38	0.24	1.89	2.52	0.24	0.74	0.98	1.38	0.26		
	SAE8	mm	70	70	35	6	58	64	6	18.5	35	35	6.5	3CC1020K11	3CC1020K21
		in	2.75	2.75	1.38	0.24	2.28	2.52	0.24	0.73	1.38	1.38	0.26		
	SAE10	mm	70	70	40	8	54	62	8	22	30	40	8.5	3CC1020L11	3CC1020L21
		in	2.75	2.75	1.57	0.31	2.12	2.44	0.31	0.87	1.18	1.57	0.33		

Dimensions and ordering codes

Cavity	Ports	Dimensions												Ordering code	
		A	B	C	E	F	G	H	I	L	M	ØZ	Aluminium	Steel	
SAE 12/2	G 1/2	mm	70	80	40	8	54	72	8	25	30	40	8.5	3CC1220D11	3CC1220D21
		in	2.75	3.15	1.57	0.31	2.12	2.83	0.31	0.98	1.18	1.57	0.33		
	G 3/4	mm	70	90	40	8	54	82	8	25	30	40	8.5	3CC1220E11	3CC1220E21
		in	2.75	3.54	1.57	0.31	2.12	3.23	0.31	0.98	1.18	1.57	0.33		
	SAE10	mm	70	85	40	8	54	77	8	25	30	40	8.5	3CC1220L11	3CC1220L21
		in	2.75	3.35	1.57	0.31	2.12	3.03	0.31	0.98	1.18	1.57	0.33		
	SAE12	mm	70	85	40	8	54	77	8	25	30	40	8.5	3CC1220M11	3CC1220M21
		in	2.75	3.35	1.57	0.31	2.12	3.03	0.31	0.98	1.18	1.57	0.33		
SAE 16/2	G 1/2	mm	80	90	50	10	60	80	10	25	35	45	10.5	3CC1620D11	3CC1620D21
		in	3.15	3.54	1.97	0.39	2.36	3.15	0.39	0.98	1.38	1.77	0.41		
	G 3/4	mm	80	90	50	10	60	80	10	25	35	45	10.5	3CC1620E11	3CC1620E21
		in	3.15	3.54	1.97	0.39	2.36	3.15	0.39	0.98	1.38	1.77	0.41		
	G 1	mm	85	100	60	10	65	90	10	23.5	40	45	10.5	3CC1620F11	3CC1620F210
		in	3.35	3.94	2.36	0.39	2.56	3.54	0.39	0.92	1.57	1.77	0.41		
	SAE12	mm	80	90	50	10	60	80	10	25	35	45	10.5	3CC1620M11	3CC1620M21
		in	3.15	3.54	1.97	0.39	2.36	3.15	0.39	0.98	1.38	1.77	0.41		
	SAE16	mm	80	100	50	10	60	90	10	25	35	45	10.5	3CC1620N11	3CC1620N21
		in	3.15	3.94	1.97	0.39	2.36	3.54	0.39	0.98	1.38	1.77	0.41		

Dimensions and ordering codes

Description composition

3/CC/- □ □ /30/ □ □ -1

Cavity

- 08
- 10
- 10Q
- 12
- 16
- 16Q

Ports

- B) G 1/4
- C) G 3/8
- D) G 1/2
- E) G 3/4
- F) G 1
- J) SAE6
- K) SAE8
- L) SAE10
- M) SAE12
- N) SAE16

Materials

- 1) Aluminium
- 2) Steel

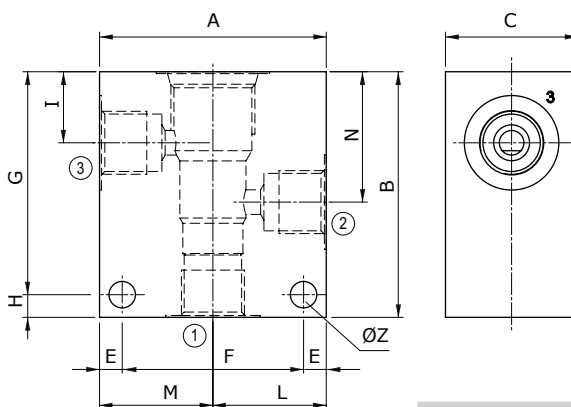

Material	Max. pressure	
	bar	psi
Alluminium	210	3050
Steel	350	5100

Cavity	Ports	Dimensions												Ordering code		
		A	B	C	E	F	G	H	I	L	M	N	ØZ	Aluminium	Steel	
SAE 08/3	G 1/4	mm	60	60	30	7	46	48	12	14.8	30	30	29.1	6.5	3CC0830B11	3CC0830B21
		in	2.36	2.36	1.18	0.27	1.81	1.89	0.47	0.58	1.18	1.18	1.14	0.25		
	G 3/8	mm	60	60	30	7	46	48	12	14.5	30	30	29.1	6.5	3CC0830C11	3CC0830C21
		in	2.36	2.36	1.18	0.27	1.81	1.89	0.47	0.57	1.18	1.18	1.14	0.25		
	G 1/2	mm	70	65	35	7	56	53	12	14.5	35	35	29.1	6.5	3CC0830D11	/
		in	2.75	2.56	1.38	0.27	2.20	2.09	0.47	0.57	1.38	1.38	1.14	0.25		
SAE6	mm	60	60	30	7	46	48	12	14.5	30	30	29.1	6.5	3CC0830J11	3CC0830J21	
	in	2.36	2.36	1.18	0.27	1.81	1.89	0.47	0.57	1.18	1.18	1.14	0.25			
SAE8	mm	60	60	30	7	46	48	12	15	30	30	29	6.5	3CC0830K11	3CC0830K11	
	in	2.36	2.36	1.18	0.27	1.81	1.89	0.47	0.59	1.18	1.18	1.14	0.25			
SAE 08/3C	G 3/8	mm	60	50	30	7	46	40	10	14.5	30	30	22	6.5	3CC0833C11	/
		in	2.36	1.97	1.18	0.27	1.81	1.57	0.39	0.57	1.18	1.18	0.87	0.25		
SAE 10/3	G 1/4	mm	60	65	35	6	48	59	6	18	30	30	34.5	7	3CC1030B11	3CC1030B21
		in	2.36	2.56	1.38	0.24	1.89	2.32	0.24	0.70	1.18	1.18	1.36	0.27		
	G 3/8	mm	60	65	35	6	48	59	6	18.8	30	30	34.5	7	3CC1030C11	3CC1030C21
		in	2.36	2.56	1.38	0.24	1.89	2.32	0.24	0.74	1.18	1.18	1.36	0.27		
	G 1/2	mm	65	70	35	6	53	64	6	18.8	32.5	32.5	34.5	7	3CC1030D11	3CC1030D21
		in	2.56	2.75	1.38	0.24	2.09	2.52	0.24	0.74	1.28	1.28	1.36	0.27		
	SAE6	mm	65	70	35	6	53	64	6	18.8	32.5	32.5	34.5	7	3CC1030J11	3CC1030J21
		in	2.56	2.75	1.38	0.24	2.09	2.52	0.24	0.74	1.28	1.28	1.36	0.27		
	SAE8	mm	65	70	35	6	53	64	6	18.8	32.5	32.5	34.5	7	3CC1030K11	3CC1030K21
		in	2.56	2.75	1.38	0.24	2.09	2.52	0.24	0.74	1.28	1.28	1.36	0.27		
	SAE10	mm	65	70	35	6	53	64	6	18	31.5	33.5	34.5	7	3CC1030L11	3CC1030L21
		in	2.56	2.75	1.38	0.24	2.09	2.52	0.24	0.70	1.24	1.32	1.36	0.27		

Dimensions and ordering codes

Cavity	Ports	Dimensions													Ordering code		
		A	B	C	E	F	G	H	I	L	M	N	ØZ	Aluminium	Steel		
SAE 10/3Q	ports 1-2 = G 1/2 port 3 = G 1/4	mm	60	70	35	6	48	64	6	14,8	30	30	31.7	7	/	3CC1032D21	
		in	2.36	2.75	1.38	0.24	1.89	2.52	0.24	0.58	1.18	1.18	1.25	0.27			
SAE 12/3	G 1/2	mm	70	100	40	8	54	92	8	25	35	35	53.5	8.5	3CC1230D11	3CC1230D21	
		in	2.75	3.94	1.57	0.31	2.12	3.6	0.31	0.98	1.38	1.38	2.10	0.33			
	G 3/4	mm	90	100	50	10	70	90	10	25.1	45	45	53.5	10.5	3CC1230E11	3CC1230E21	
		in	3.54	3.94	1.97	0.39	2.75	3.54	0.39	0.99	1.77	1.77	2.11	0.41			
	SAE10		mm	80	100	40	8	64	92	8	25	40	40	53.5	8.5	3CC1230L11	3CC1230L21
			in	3.15	3.94	1.57	0.31	2.52	3.6	0.31	0.98	1.57	1.57	2.11	0.33		
	SAE12		mm	80	100	45	8	64	92	8	25	40	40	53.5	8.5	3CC1230M11	3CC1230M21
			in	3.15	3.94	1.77	0.31	2.52	3.6	0.31	0.98	1.57	1.57	2.11	0.33		
SAE16/3	G 1/2	mm	90	100	50	10	70	90	10	25	45	45	53.5	10.5	3CC1630D11	3CC1630D21	
		in	3.54	3.94	1.97	0.39	2.75	3.54	0.39	0.98	1.77	1.77	2.11	0.41			
	G 3/4	mm	90	100	50	10	70	90	10	25.1	45	45	53.5	10.5	3CC1630E11	3CC1630E21	
		in	3.54	3.94	1.97	0.39	2.75	3.54	0.39	0.99	1.77	1.77	2.11	0.41			
	G 1		mm	90	105	50	10	70	95	10	25	46	44	53.5	10.5	3CC1630F11	3CC1630F21
			in	3.54	4.13	1.97	0.39	2.75	3.74	0.39	0.98	1.81	1.73	2.11	0.41		
	SAE12		mm	90	105	50	10	70	95	10	25.1	45	45	53.5	10.5	3CC1630M11	3CC1630M21
			in	3.54	4.13	1.97	0.39	2.75	3.74	0.39	0.99	1.77	1.77	2.11	0.41		
	SAE16		mm	90	105	50	10	70	95	10	25.1	45	45	53.5	10.5	3CC1630N11	3CC1630N21
			in	3.54	4.13	1.97	0.39	2.75	3.74	0.39	0.99	1.77	1.77	2.11	0.41		
SAE 16/3Q	ports 1-2 = G 3/4 port 3 = G 1/4	mm	80	85	50	10	60	75	10	17.2	40	40	38.1	10.5	/	3CC1632E21	
		in	3.15	3.35	1.97	0.39	2.36	2.95	0.39	0.68	1.57	1.57	1.50	0.41			

Dimensions and ordering codes

Description composition

3/CC/- □ □ /40/ □ □ -1

Cavity

- 08
- 10
- 12
- 16

Ports

- B) G 1/4
- C) G 3/8
- D) G 1/2
- E) G 3/4
- F) G 1
- J) SAE6
- K) SAE8
- L) SAE10
- M) SAE12
- N) SAE16

Materials

- 1) Aluminium
- 2) Steel

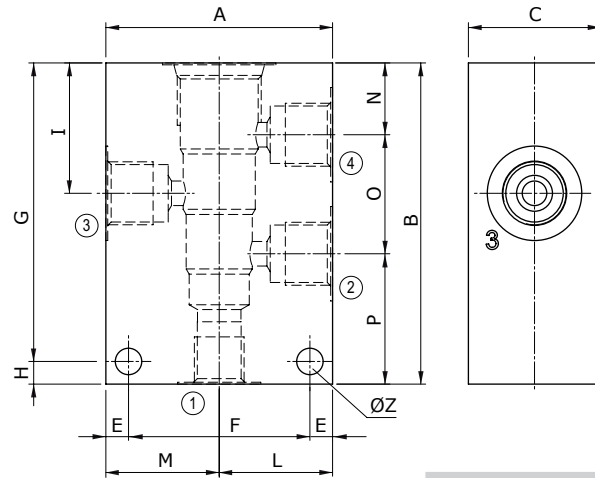

Material	Max. pressure	
	bar	psi
Alluminium	210	3050
Steel	350	5100

Cavity	Ports	Dimensions														Ordering code			
		A	B	C	E	F	G	H	I	L	M	N	O	P	ØZ	Aluminium	Steel		
SAE 08/4	G 1/4	mm	60	75	30	7	46	63	12	29.1	30	30	14.8	29.1	31.1	6.5	3CC0840B11	3CC0840B21	
		in	2.36	2.95	1.18	0.27	1.81	2.48	0.47	1.14	1.18	1.18	0.58	1.14	1.22	0.25			
	G 3/8	mm	60	75	30	7	46	63	12	29.1	30	30	14.8	28.6	31.6	6.5	3CC0840C11	3CC0840C21	
		in	2.36	2.95	1.18	0.27	1.81	2.48	0.47	1.14	1.18	1.18	0.58	1.13	1.24	0.25			
	SAE6	SAE6	mm	60	75	30	7	46	63	12	29.1	30	30	14.8	29.1	31.1	6.5	3CC0840J11	3CC0840J21
			in	2.36	2.95	1.18	0.27	1.81	2.48	0.47	1.14	1.18	1.18	0.58	1.14	1.22	0.25		
SAE8	SAE8	mm	60	75	30	7	46	63	12	29	30	30	15	28.5	31.5	6.5	3CC0840K11	3CC0840K21	
		in	2.36	2.95	1.18	0.27	1.81	2.48	0.47	1.14	1.18	1.18	0.59	1.12	1.24	0.25			
SAE 10/4	G 1/4	mm	60	85	35	6	48	79	6	34.5	30	30	19	31.5	34.5	7	3CC1040B11	3CC1040B21	
		in	2.36	3.35	1.38	0.24	1.89	3.11	0.24	1.36	1.18	1.18	0.75	1.24	1.36	0.27			
	G 3/8	mm	60	85	35	6	48	79	6	34.5	30	30	18.8	31.7	34.5	7	3CC1040C11	3CC1040C21	
		in	2.36	3.35	1.38	0.24	1.89	3.11	0.24	1.36	1.18	1.18	0.74	1.25	1.36	0.27			
	G 1/2	mm	70	85	35	6	58	79	6	34.5	35	35	18.8	31.7	34.5	7	3CC1040D11	3CC1040D21	
		in	2.75	3.35	1.38	0.24	2.28	3.11	0.24	1.36	1.38	1.38	0.74	1.25	1.36	0.27			
	SAE6	SAE6	mm	60	85	35	6	48	79	6	34.5	30	30	18.8	31.7	34.5	7	3CC1040J11	3CC1040J21
			in	2.36	3.35	1.38	0.24	1.89	3.11	0.24	1.36	1.18	1.18	0.74	1.25	1.36	0.27		
	SAE8	SAE8	mm	70	85	35	6	58	79	6	34.5	35	35	18.8	31.7	34.5	7	3CC1040K11	3CC1040K21
			in	2.75	3.35	1.38	0.24	2.28	3.11	0.24	1.36	1.38	1.38	0.74	1.25	1.36	0.27		
	SAE10	SAE10	mm	70	85	35	6	58	79	6	34.5	35	35	19	31.5	34.5	7	3CC1040L11	3CC1040L11
			in	2.75	3.35	1.38	0.24	2.28	3.11	0.24	1.36	1.38	1.38	0.75	1.24	1.36	0.27		

Dimensions and ordering codes

Cavity	Ports		Dimensions													Ordering code		
			A	B	C	E	F	G	H	I	L	M	N	O	P	ØZ	Aluminium	Steel
SAE 12/4	G 3/8	mm	80	115	40	8	64	107	8	44	40	40	22	44.5	48.5	8.5	3CC1240C11	3CC1240C21
		in	3.15	4.53	1.57	0.31	2.52	4.21	0.31	1.73	1.57	1.57	0.87	1.75	1.9	0.33		
	G 1/2	mm	80	115	40	8	64	107	8	44	40	40	22	44.5	48.5	8.5	3CC1240D11	3CC1240D21
		in	3.15	4.53	1.57	0.31	2.52	4.21	0.31	1.73	1.57	1.57	0.87	1.75	1.9	0.33		
	SAE10	mm	80	115	40	8	64	107	8	44	40	40	22	44.5	48.5	8.5	3CC1240L11	3CC1240L21
		in	3.15	4.53	1.57	0.31	2.52	4.21	0.31	1.73	1.57	1.57	0.87	1.75	1.9	0.33		
SAE 16/4	G 3/4	mm	100	130	50	10	80	120	10	53.5	50	50	25.1	56.9	48	10.5	3CC1640E11	3CC1640E21
		in	3.94	5.12	1.97	0.39	3.15	4.72	0.39	2.11	1.97	1.97	0.99	2.24	1.89	0.41		
	SAE16	mm	100	130	50	10	80	120	10	53.5	50	50	25.1	56.9	48	10.5	3CC1640N11	3CC1640N21
		in	3.94	5.12	1.97	0.39	3.15	4.72	0.39	2.11	1.97	1.97	0.99	2.24	1.89	0.41		

How to order valves with body

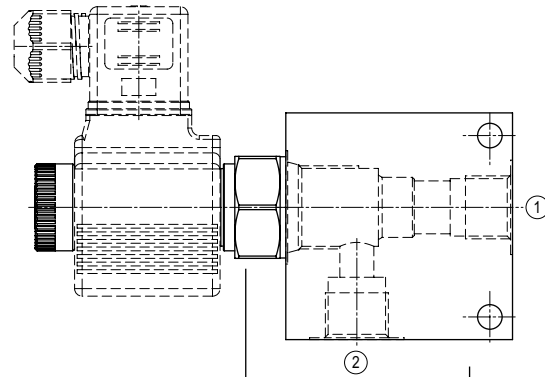

Cartridge description

Body description

EC 10 M/10NB

C 1 1

Cavity

Ports

Materials

- 08**
- 10**
- 12**
- 16**

- B) G 1/4**
- C) G 3/8**
- D) G 1/2**
- E) G 3/4**
- F) G 1**
- J) SAE6**
- K) SAE8**
- L) SAE10**
- M) SAE12**
- N) SAE16**

- 1) Aluminium**
- 2) Steel**

Dimensions

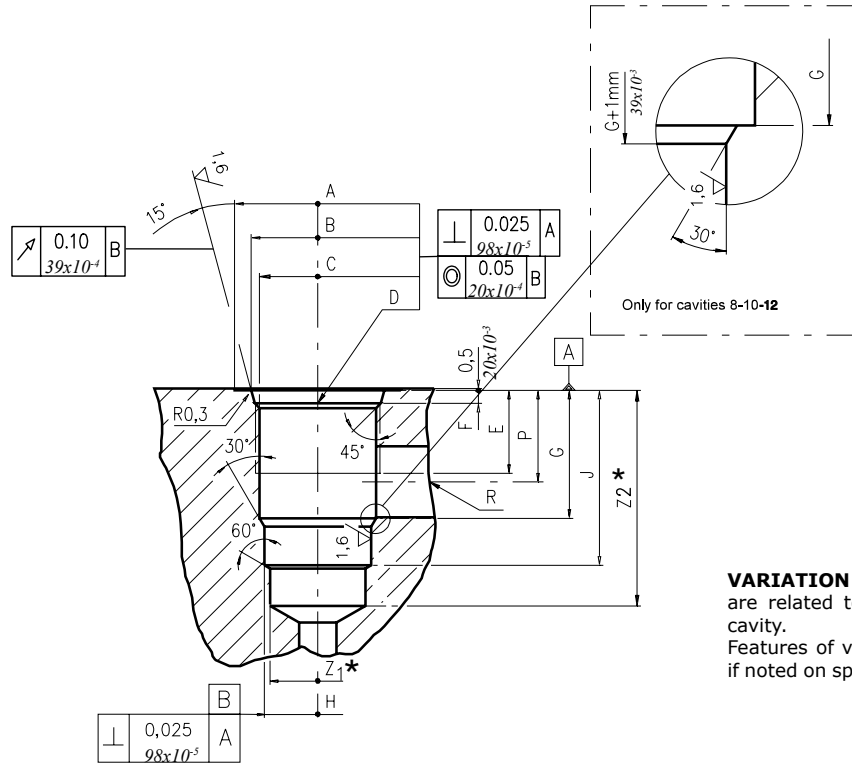

VARIATION "A": the dimensions with "*" are related to the variation "A" of 2 way cavity. Features of variation "A" are required only if noted on specific product catalogue page.

Cavity	A	B ±0.05	C ±0.05	D	E	F	G	H ±0.02	J	K ±0.02	L	M ±0.02	N	P	R ØMAX	S ØMAX	T ØMAX	U ØMAX	V ØMAX	X ØMAX	Z1* ØMIN	Z2* MIN
08/2	mm 27	20.66	17.42	3/4-16 UNF	12.5	2.5	18.2	12.72	29.5	-	-	-	-	14	8	-	-	-	-	-	12	39
08/2 A	in 1.06	0.81	0.68		0.49	0.10	0.72	0.50	1.16	-	-	-	-	-	0.55	0.31	-	-	-	-	-	0.47
10/2	mm 30	24	20.62	7/8-14 UNF	16	2.8	24	15.9	33.5	-	-	-	-	18.3	11	-	-	-	-	-	14.5	40
10/2 A	in 1.18	0.94	0.81		0.63	0.11	0.94	0.62	1.32	-	-	-	-	-	0.72	0.43	-	-	-	-	-	0.57
12/2	mm 38	29.23	24.73	1 1/16-12 UNF	19	3.5	34.15	22.25	46.8	-	-	-	-	24.5	19	-	-	-	-	-	21.5	60
12/2 A	in 1.50	1.15	0.97		0.75	0.14	1.34	0.87	1.84	-	-	-	-	-	0.96	0.75	-	-	-	-	-	0.85
16/2	mm 45	35.6	31.34	1 5/16-12 UNF	22	3.50	34	28.62	47	-	-	-	-	24.5	19	-	-	-	-	-	25.5	70
16/2 A	in 1.77	1.40	1.23		0.87	0.14	1.34	1.13	1.85	-	-	-	-	-	0.96	0.75	-	-	-	-	-	1.00

Rougher tool

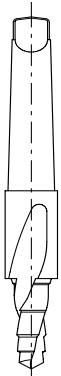

Cavity	Ordering code
08/2	UDPF175030
08/2A	UDPF175030
10/2	UDPF20503F
10/2A	UDAS24003C
12/2	UDAS380031
12/2A	UDAS380031
16/2	UDPF313031
16/2A	UDPF313031

Finisher tool



Cavity	Ordering code
08/2	UCAC127066
08/2A	UCAC127060
10/2	UCAC159080
10/2A	UCAC159080
12/2	UDAC222661
12/2A	UDAC222661
16/2	UDAC286261
16/2A	UDAC286261

Tap



Cavity	Ordering code
08/2	UCMS3/4161
08/2A	UCMS3/4161
10/2	UCMS7/8142
10/2A	UCMS7/8142
12/2	UCMS11/162
12/2A	UCMS11/162
16/2	UCMS15/160
16/2A	UCMS15/160

Cavity plugs

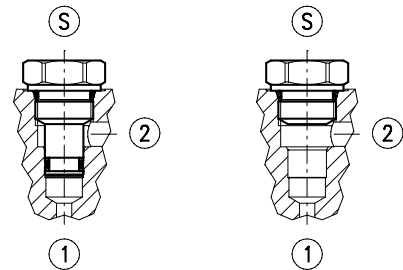

Cavity	Ordering code	①	②	Ⓢ
08/2	3XTP3533700	X	X	X
08/2A	4TP5531500	0	0	X
10/2	3XTP3544200	X	X	X
10/2A	3XTP1542300	0	0	X
12/2	3XTP3555400	X	X	X
12/2A	3XTP1552900	0	0	X
16/2	3XTP3575500	X	X	X
16/2A	3XTP838200	0	0	X

X=Close 0=Open

Dimensions

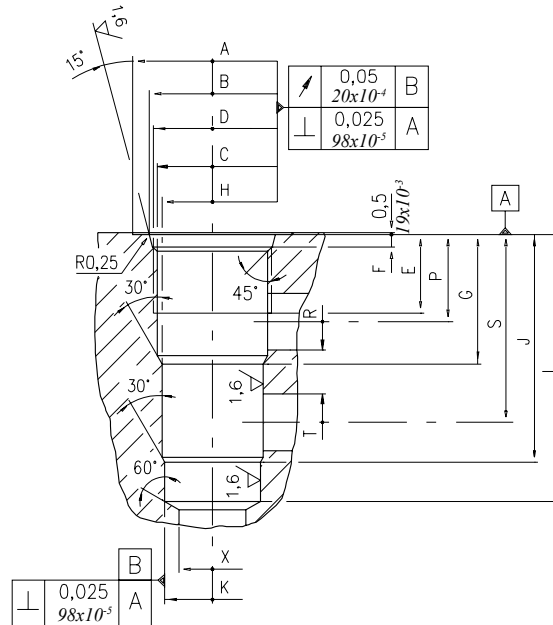

Cavity	A	B ±0,05	C ±0,05	D	E	F	G	H ±0,02	J	K ±0,02	L	M ±0,02	N	P	R øMAX	S øMAX	T øMAX	U øMAX	V øMAX	X øMAX	
08/3	mm	27	20.66	17.42	3/4 -16 UNF	12.5	2.5	19.1	15.90	33.3	14.3	43.3	-	-	14.3	5.5	28.6	5.5	-	-	12.5
	in	1.06	0.81	0.68		0.49	0.10	0.75	0.62	1.31	0.56	1.70	-	-	0.56	0.22	1.12	0.22	-	-	0.49
08/3C	mm	27	20.66	17.42	3/4 -16 UNF	10	2.5	14.3	15.9	25.2	14.3	31.5	-	-	10.5	5	21.5	5	-	-	12.5
	in	1.06	0.81	0.68		0.39	0.10	0.56	0.62	1.31	0.56	1.70	-	-	0.41	0.20	0.85	0.20	-	-	0.49
10/3	mm	30	24	20.62	7/8 -14 UNF	16	2.8	23.1	17.5	39.6	15.9	47.6	-	-	18.3	6.5	34	6.5	-	-	14
	in	1.18	0.94	0.81		0.63	0.11	0.94	0.69	1.56	0.62	1.87	-	-	0.72	0.25	1.34	0.25	-	-	0.55
12/3	mm	38	29.23	24.73	1 1/16 -12 UNF	19	3.56	36.6	23.82	63.5	22.25	75.4	-	-	24.5	16	53	16	-	-	19
	in	1.50	1.15	0.97		0.75	0.14	1.44	0.94	2.5	0.88	2.97	-	-	0.96	0.63	2.09	0.63	-	-	0.75
16/3	mm	45	35.6	28.62	1 5/16 -12 UNF	22	3.5	36.5	28.62	64.3	27.02	75.3	-	-	24.5	16	53	16	-	-	19
	in	1.77	1.40	1.13		0.87	0.14	1.44	1.13	2.53	1.06	2.96	-	-	0.96	0.63	2.09	0.63	-	-	0.75
20/3	mm	58	43.6	36.55	1 5/8 -12 UNF	21	3.5	46	36.55	87.6	33.37	100	-	-	31	25.4	71.5	25.4	-	-	30
	in	2.28	1.71	1.44		0.83	0.14	1.81	1.04	3.45	1.31	3.93	-	-	1.22	1	2.81	1	-	-	1.18

Cavity plugs

Rougher tool

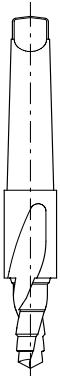

Cavity	Ordering code
08/3	UDAS207021
08/3C	UDPF174021
10/3	UDPF20503B
12/3	UDAS380032
16/3	UDAS450032
20/3	UT05X55380

Finisher tool

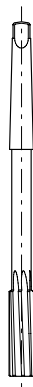

Cavity	Ordering code
08/3	UDAS159064
08/3C	UDAS159063
10/3	UDAC175080
12/3	UDAS238060
16/3	UDAS286261
20/3	UT05X55390

Tap



Cavity	Ordering code
08/3	UCMS3/4161
08/3C	UCMS3/4161
10/3	UCMS7/8142
12/3	UCMS11/162
16/3	UCMS15/160
20/3	UCMS15/812

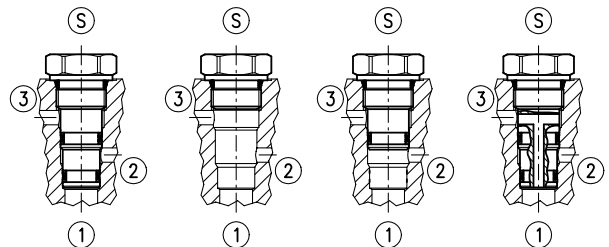

Cavity	Ordering code	①	②	③	Ⓢ
08/3	XTAP324541	X	X	X	X
	3XTAP822150	0	0	0	X
	XTAP324400	0	0	X	X
	XTAP324540	0	X	0	X
08/3C	XTAP824370	X	X	X	X
	3XTAP822150	0	0	0	X
	3XTP3545700	X	X	X	X
10/3	3XTP1542300	0	0	0	X
	3XTP3545701	0	X	0	X
	3XTP3558200	X	X	X	X
12/3	3XTP1552900	0	0	0	X
	3XTP3558201	0	X	0	X
16/3	3XTP3578400	X	X	X	X
	3XTAP838200	0	0	0	X

X=Close 0=Open

Dimensions

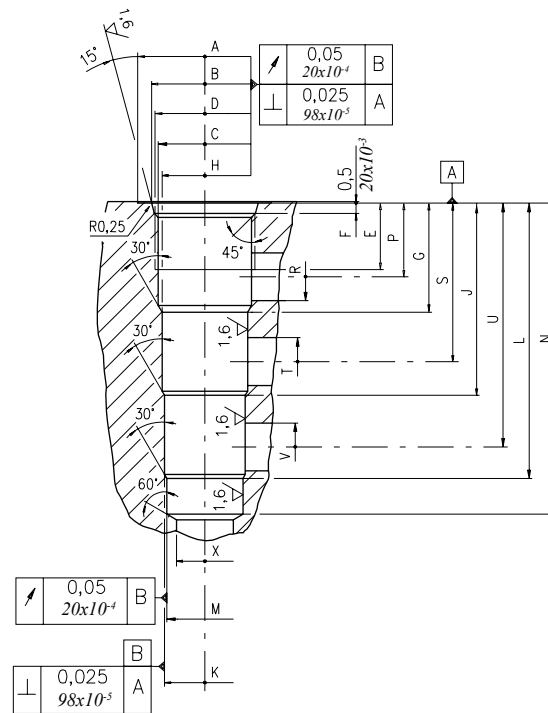

Cavity	A	B $\pm 0,05$	C $\pm 0,05$	D	E	F	G	H $\pm 0,02$	J	K $\pm 0,02$	L	M $\pm 0,02$	N	P	R ϕMAX	S	T ϕMAX	U	V ϕMAX	X ϕMAX	
08/4	mm	28.00	20.66	17.42	3/4-16 UNF	12.5	2.5	19.1	15.9	33.3	14.3	47.6	12.72	57.6	14.3	5.5	28.6	5.5	42.9	5.5	11
	in	1.10	0.81	0.68		0.49	0.10	0.75	0.62	1.31	0.56	1.87	0.50	2.27	0.56	0.22	1.12	0.22	1.69	0.22	0.43
10/4	mm	30	24.00	20.62	7/8-14 UNF	16	2.8	23.6	19.08	39.6	17.5	55.4	15.9	63.5	18.3	6.5	34	6.5	50	6.5	14
	in	1.18	0.94	0.81		0.63	0.11	0.93	0.75	1.56	0.69	2.18	0.62	2.50	0.72	0.26	1.34	0.25	1.97	0.25	0.55
12/4	mm	38	29.23	24.73	1 1/16-12 UNF	19	3.56	29.5	23.82	51.5	22.25	73.6	20.65	83.33	21.5	11	43.5	11	66	11	19
	in	1.50	1.15	0.97		0.75	0.14	1.16	0.94	2.03	0.87	2.90	0.81	3.28	0.85	0.43	1.71	0.43	2.60	0.43	0.75
16/4	mm	45	35.60	31.34	1 5/16-12 UNF	22	3.5	36.5	28.62	64.3	27.02	92.07	25.45	104	24.6	16	53	16	81.5	16	19
	in	1.77	1.40	1.23		0.87	0.14	1.44	1.13	2.53	1.06	3.62	1.00	4.09	0.97	0.63	2.09	0.63	3.21	0.63	0.75

Cavity plugs

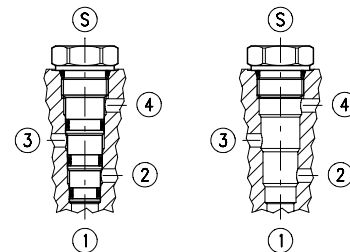

Rougher tool

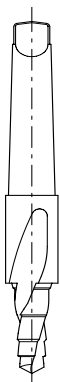

Finisher tool



Tap



Cavity	Ordering code
08/4	UDAS207020
10/4	UDAS30003H
12/4	UDAS292020
16/4	UDAS356030

Cavity	Ordering code
08/4	UDAS170080
10/4	UDAS190861
12/4	UDAS238260
16/4	UDAS286262

Cavity	Ordering code
08/4	UCMS3/4161
10/4	UCMS7/8142
12/4	UCMS11/162
16/4	UCMS15/160

Cavity	Ordering code	①	②	③	④	Ⓢ
08/4	3XTP3536500	X	X	X	X	X
	3XTAP822150	0	0	0	0	X
10/4	3XTP3548301	X	X	X	X	X
	3XTP1542300	0	0	0	0	X
12/4	3XTP3559300	X	X	X	X	X
	3XTP1552900	0	0	0	0	X
16/4	3XTP357B300	X	X	X	X	X
	3XTAP838200	0	0	0	0	X

X=Close 0=Open



Innovation · Continuity · Integration
————— It is Power —————



D1WWEI01A
13th edition May 2020

Walvoil S.P.A. • 42124 Reggio Emilia • Italy • Via Adige, 13/D • Tel. +39.0522.932411 • Fax +39.0522.300984
www.walvoil.com

